

## ATTACHMENT 35

EPA Response to Comments



**UNITED STATES ENVIRONMENTAL PROTECTION AGENCY**  
**REGION 8**  
1595 Wynkoop Street  
DENVER, CO 80202-1129  
Phone 800-227-8917  
[www.epa.gov/region8](http://www.epa.gov/region8)

**EPA Region 8**  
**Underground Injection Control (UIC) Program**  
**Response to Public Comments**

**Class III Area Permit No. SD31231-00000, Aquifer Exemption Decision**  
**And**  
**Class V Area Permit No. SD52173-00000**

**Issued to:**

**Powertech (USA) Inc.**  
P.O. Box 448  
Edgemont, South Dakota 57735

Final Permit issuance: November 24, 2020

# Table of Contents

INTRODUCTION.....	1
Background .....	1
EPA’s 2017 Public Review Process .....	1
EPA’s 2019 Public Review Process .....	2
EPA’s Final Permit Decision Making Process .....	3
CHANGES TO THE FINAL PERMITS .....	4
Changes to the Class III Area Permit .....	4
Changes to the Class V Area Permit.....	68
RESPONSE TO COMMENTS .....	100
Postponement of Actions .....	100
Concerns About Geology and Confinement .....	101
Class III Permit.....	119
Concerns that Groundwater Cannot Be Returned to Baseline.....	120
Concerns Related to Water Quality Data.....	122
Permit boundary .....	130
Wastewater from pump tests.....	130
Timing of wellfield testing/sampling.....	131
Limit on Number of Wells .....	132
Well Construction and Mechanical Integrity .....	133
Change in Annual Requirement to Construct to Annual Reporting.....	138
Pumping Rates .....	138
Water level at wellfield perimeter monitoring wells.....	139
Constituent Levels.....	139
Reporting Spills .....	140
Clean up plan .....	141
Excursions .....	142
Concerns About Monitoring .....	144
Specific Modeling Concerns.....	154
Standards too Stringent .....	161
Concern About 40 CFR § 144.12 .....	166
Specific Class III Permit Comments from Powertech not Addressed in Other Responses .....	170
Aquifer Exemption .....	174

Clarifications .....	174
Current/Future Source of Drinking Water .....	180
Commercial Producibility .....	183
Class V Permit .....	186
Concern About Inaccurate Information .....	186
Testing Before Permit Issuance .....	187
Concerns About Geology and Confinement .....	189
Inventory of Waste .....	200
Well Classification/Treatment of Water .....	202
Groundwater Flow Direction .....	206
Number of Wells .....	207
Concerns About Testing .....	207
Immediate Plugging and Abandonment .....	209
Seismicity .....	209
Limitation on Injectate .....	217
Powertech Class V Comments Not Addressed in other Responses .....	217
Financial Responsibility .....	227
Public Process and Rulemaking Comments .....	229
General Concerns .....	234
Tribal Consultation .....	241
Tribal Treaty Rights .....	249
General Tribal Concerns .....	261
Environmental Justice .....	266
Comments on the Geographic Scope of the Environmental Justice Analysis .....	266
Comments on the Black Hills as a Sacred Site .....	280
General Comments on the Environmental Justice Analysis .....	292
Comments on Environmental Justice Considerations in The Permitting Process .....	297
Table 1. EPA Tribal Consultation and Related Events .....	298
Table 2. List of Tribes Identified as Potential Consulting Parties. ....	303
Additional Issues Raised by Comments on the Environmental Justice Analysis .....	307
National Historic Preservation Act Comments .....	309
National Environmental Policy Act .....	312
Cumulative Effects Analysis .....	316

Endangered Species Act..... 392  
Outside the Scope of the Actions ..... 398  
APPENDIX-POWERTECH COMMENT TABLES WITH EPA RESPONSES ..... 405

## **INTRODUCTION**

EPA Region 8 Underground Injection Control (UIC) Program is issuing two UIC Area Permits to Powertech (USA) Inc. (Powertech) for injection activities related to uranium recovery in the southern Black Hills of South Dakota. One is a UIC Class III Area Permit for injection wells for the In-Situ Recovery (ISR) of uranium in the Inyan Kara Formation. The second is a UIC Class V Area Permit for deep injection wells that will be used to dispose of ISR process waste fluids, after treatment to ensure that the injected fluids are below radioactive or hazardous waste levels, into the Minnelusa Formation below the Inyan Kara. EPA is also issuing an aquifer exemption approval in connection with the UIC Class III Area Permit. Specifically, this approval exempts from protection under the Safe Drinking Water Act (SDWA), the uranium-bearing portions of the Inyan Kara Group aquifers in Burdock Area Wellfields 1 through 5, 9 and 10 and Dewey Area Wellfields 1 through 4. Such an exemption must be in place before ISR activities within these aquifers can occur.

### **Background**

EPA's UIC Program received permit applications from Powertech related to the ISR of uranium at the proposed Dewey-Burdock Site in South Dakota. This proposed site is located in the southern Black Hills in South Dakota on the South Dakota-Wyoming state line in southwest Custer and northwest Fall River Counties. The site is located approximately 13 miles northwest of Edgemont, SD and 46 miles west of the western border of the Pine Ridge Indian Reservation.

The project will involve the injection of lixiviant, consisting of injection interval groundwater with added oxygen and carbon dioxide, into the uranium ore deposits within the Inyan Kara Formation targeted by 14 wellfields. These wellfields will consist of an approximate total of 1,500 Class III injection wells. Class III injection wells will be used to inject the lixiviant into the uranium ore zones. The lixiviant will mobilize uranium from the ore deposits and allow production wells to pump the uranium-bearing lixiviant out of the ground to a processing unit where the uranium will be removed from solution using an ion exchange resin. The barren lixiviant will be pumped from the processing unit back to the ISR wellfield where oxygen and carbon dioxide will be added before injection back into uranium ore deposits through the Class III wells.

In addition to Powertech's permit application to inject fluids into the uranium deposits located within the Fall River and Chilson Sandstone aquifers of the Inyan Kara Formation, the company submitted a request to exempt these aquifers from protection as USDWs. As part of this action, EPA is approving an exemption of portions of these aquifers. Specifically, these aquifers meet the definition of USDWs in the UIC regulations because their total dissolved solids concentrations are less than 10,000 mg/L and yield a sufficient quantity of water to supply a public water system. EPA is exempting the uranium-bearing portions of these aquifers under the UIC regulatory exemption process based on information included in Powertech's application demonstrating that these aquifers currently do not serve as a source of drinking water and will not serve as a future source of drinking water because minerals occur in economically producible quantities within such aquifers.

### **EPA's 2017 Public Review Process**

On March 6, 2017, EPA Region 8 UIC Program published a public notice on EPA's Region 8 UIC website: <https://www.epa.gov/uic/epa-dewey-burdock-class-iii-and-class-v-injection-well-draft-area-permits> announcing the proposal of two UIC Area Permits to Powertech for injection activities related to uranium recovery and an accompanying aquifer exemption. The public comment period was originally

scheduled to end on May 19, 2017. However, EPA granted an extension to the public comment period through June 19, 2017. EPA solicited comments on the two UIC Area Permits and the aquifer exemption record of decision (ROD). EPA also issued a draft Environmental Justice Analysis, a draft document outlining EPA National Historic Preservation Act (NHPA) section 106 consultation process, and a Cumulative Effects Analysis document. In addition to the public notice on EPA Region 8's UIC Program website, EPA published notice of the issuance of the draft UIC permits in the *Lakota Country Times*, the *Edgemont Herald Tribune*, the *Rapid City Journal*, and the *Custer County Chronicle*. A notice was also posted on <http://www.indianz.com>. All of these notices directed readers to EPA Region 8's UIC Program website, which contained links to the Administrative Record for the proposed actions.

EPA received comments from the public through testimony given during the public hearings listed below, email and written correspondence. EPA held the following public hearings:

Thursday, April 27, 2017 from 4:00 to 8:30 p.m. (with a break from 6:00 to 6:30 p.m.)

Niobrara Lodge  
803 US Highway 20  
Valentine, Nebraska 69201

Monday-Tuesday, May 8-9, 2017, from 1:00 to 8:00 p.m. (with a break from 5:00 to 6:00 p.m.)

The Best Western Ramkota Hotel  
2111 N. LaCrosse Street  
Rapid City, South Dakota 57701

Wednesday, May 10, 2017, from 1:00 to 8:00 pm (with a break from 5:00 to 6:00 p.m.)

The Mueller Center  
801 S 6th Street  
Hot Springs, South Dakota 57747

Thursday, May 11, 2017, from 1:00 to 8:00 pm (with a break from 5:00 to 6:00 pm)

St. James Catholic Church  
310 3rd Avenue  
Edgemont, South Dakota 57735

EPA reviewed the comments received during the public comment period and determined it would be appropriate to update the Class III and Class V draft area permits and associated documents and provide another opportunity for public notice and comment.

### **EPA's 2019 Public Review Process**

On August 26, 2019, EPA Region 8 UIC Program published a public notice on EPA's Region 8 UIC website: <https://www.epa.gov/uic/epa-dewey-burdock-class-iii-and-class-v-injection-well-draft-area-permits-2019> announcing updated UIC draft Class III and V Area Permits to Powertech for injection activities related to uranium recovery and an accompanying aquifer exemption. In addition to the updated draft permits, EPA issued an updated draft Aquifer Exemption Record of Decision, an updated draft Environmental Justice Analysis and an updated NHPA process document for public review and comment.

EPA also published notice of the issuance of the updated UIC draft Class III and V permits and associated documents in the *Lakota Country Times*, the *Fall River County Herald*, the *Rapid City Journal*, and the *Custer County Chronicle*. A notice was also posted on <http://www.indianz.com>. All of these notices directed readers to EPA Region 8 UIC Program website, which contained links to the Administrative Record for these proposed actions.

EPA set up Docket EPA-R08-OW-2019-0512 on the regulations.gov website to receive comments. EPA also received comments from the public through testimony given during the public hearings listed below, email and written correspondence. EPA held the following additional public hearing:

Saturday, October 5, 2019, from 9:00 am to 6:00 pm (with a break from 1:00 to 2:00 pm)  
The Mueller Center  
801 S 6th Street  
Hot Springs, South Dakota 57747

A written transcript of all hearings is available to the public as part of the Administrative Record for the Final Area Permit decisions.

### **EPA's Final Permit Decision Making Process**

EPA received thousands of comments on the Draft Permits and associated documents including the Draft Aquifer Exemption ROD during the 2017 and 2019 comment periods, hundreds of emails, and thousands of pages of reference documents. All comments included in the Administrative Record for EPA's Final Permit decisions are on the regulations.gov website, Docket EPA-R08-OW-2019-0512.

EPA followed the regulatory requirements for decision making regarding injection well area permits, including consideration of public comments. EPA reviewed and considered every comment submitted. EPA also considered all comments received from tribal governments during consultation meetings with interested tribes and followed up with each consulting tribe as to how its input was considered and/or informed EPA's decisions consistent with *EPA's Policy on Consulting and Coordinating with Indian Tribes*.

EPA has prepared this document to: 1) identify changes reflected in its Final Permits and the reasons for those changes; and 2) respond to all significant comments received that are relevant to the UIC Class III and V Draft Area Permits and associated documents. In issuing its Final Permit decisions, EPA has also notified the applicant and each person/party who submitted comments or requested notice of the Final Permit decisions. A final permit decision means a final decision to issue or deny the permit. This document has been included in the notification of the Final Permit decisions. The notice also included reference to the procedures for appealing a decision on a UIC permit under 40 CFR § 124.19.

Since EPA received comments on the UIC Class III and V Draft Area Permits during the public review process, the Final Area Permit decisions will not be effective until 30 days after the final permit issuance date (noted above) as required by 40 CFR § 124.15. The purpose of this 30-day period is to allow time for those who submitted comments or participated in a public hearing to appeal the final permit decisions as described under 40 CFR § 124.19, which is paraphrased below.

Within 30 days after the UIC final permit decisions have been issued, any person who filed comments on the draft permits or participated in a public hearing may petition the Environmental Appeals Board to review any condition of the permit decisions. Any person who failed to file comments or failed to participate in a public hearing on the draft permits may petition for administrative review only to the extent of the changes from the draft to the final permit decisions. The 30-day period within which a person may request review under this section begins with the service of notice of EPA's final permit decisions unless a later date is specified in that notice. The petition must identify the contested permit condition or other specific challenge to the permit decision and clearly set forth, with legal and factual support, contentions for why the permit decision should be reviewed, including a demonstration that any issues being raised were raised during the public comment period (including any public hearing) to



the extent required by these regulations and , a showing that the condition in question is based on a finding of fact or conclusion of law which is clearly erroneous.

### **CHANGES TO THE FINAL PERMITS**

Pursuant to the permitting regulations at 40 CFR § 124.17, this section of the Response to Comments specifies which provisions of the draft permits have been changed in the final permit decisions and provides a reason for each change.

#### **Changes to the Class III Area Permit**

1. EPA changed uses of “shall” in the Permit to “must” to indicate required actions by the Permittee.

**Reason for change:** In keeping with the federal government’s plain language guidelines (see [www.plainlanguage.gov](http://www.plainlanguage.gov)), and the Plain Language Act of 2010, this is to provide greater clarity, as “shall” is ambiguous.

2. **Cover pages and Part I Introduction:**

The operator’s address was updated.

**Draft Permits:**

Powertech (USA) Inc.  
5575 DTC Parkway, Suite 140,  
Greenwood Village, Colorado 80111

**Final Permits:**

Powertech (USA) Inc.  
P.O. Box 448  
Edgemont, SD 57735

**Reason for change:** To provide the Permittee’s updated address.

3. **Part I, Signature page:**

**Draft language:**

\*NOTE: Throughout this Permit the term “Director” refers to either the Chief of the Safe Drinking Water Branch of the Water Division or the Chief of the Water Enforcement Branch of the Enforcement and Compliance Assurance Division.

**Final language:**

NOTE: Throughout this Permit the term “Director” refers to either the Director of the Water Division (or authorized representative) or the Chief of the Water Enforcement Branch of the Enforcement and Compliance Assurance Division (or authorized representative).

**Reason for change:** To provide greater clarity on who in EPA can be defined as “Director” for purposes of this permit, in accordance with Delegations of Authority.

4. **References to EPA in its role as UIC Program Director were replaced with “Director” at the following places:**

Part II, Section H.1  
Part IX, Section E.3

**Reason for change:** To improve internal consistency within the Permit.

**5. Part I: Figure 2b:**

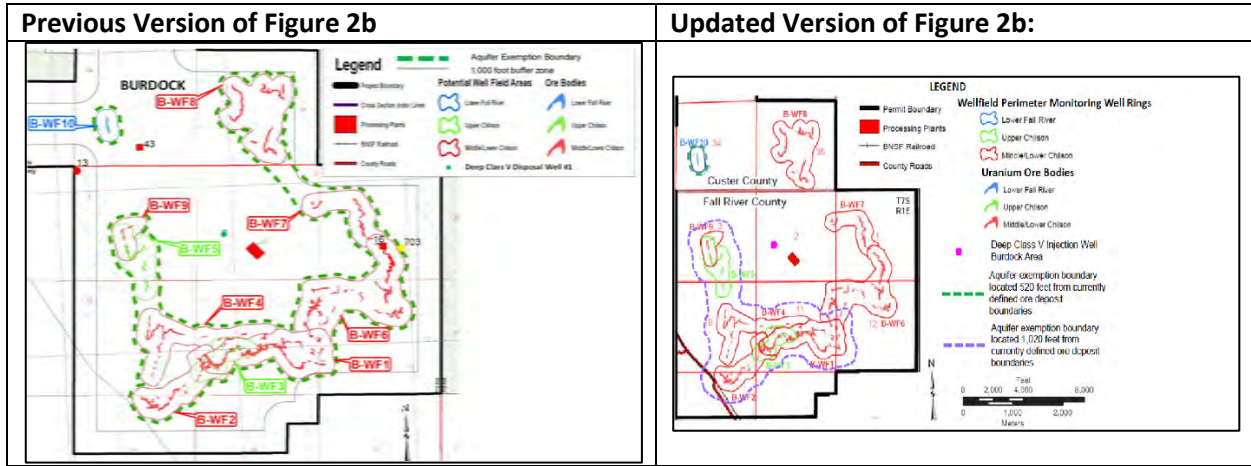

**Reason for change:** Figure 2b has been updated to show the new final aquifer exemption boundary for Burdock Wellfields 1 through 5 and 9. The AE boundary was removed around Burdock Wellfields 6, 7 and 8 because EPA did not approve the AE for these wellfields for reasons discussed in Change #23 to the Class III Permit below. The AE boundary around Burdock Wellfield 10 is the green-dashed line located 120 feet from the perimeter monitoring well ring. The Dewey AE boundary is shown in Figure 2a of the Class III Area Permit and was not included here, because there were no changes to the AE boundary in the Dewey Area.

**6. Part II: Section B.1.d:**

**Draft language:**

- d. If the horizontal extent of any uranium ore deposit as determined by wellfield delineation drilling results in relocation of the aquifer exemption boundary more than 800 feet from the location shown in Figures 2a and 2b, the Permittee must submit a new aquifer exemption application to the Director for review and approval.
- iii. The Permittee must obtain the Director’s approval of the aquifer exemption before installing any injection and production wells that would result in relocation of the aquifer exemption boundary more than 800 feet from the location shown in Figures 2a and 2b.

**Final language:**

- d. If the horizontal extent of any uranium ore deposit as determined by wellfield delineation drilling results indicates expansion of the aquifer exemption boundary is needed, beyond the locations shown in Figures 2a and 2b, the Permittee must submit a new aquifer exemption application to the Director for review and approval.
- iii. The Permittee must obtain the Director’s approval of the aquifer exemption before installing any injection and production wells that would result in expansion of the aquifer exemption boundary beyond the locations shown in Figures 2a and 2b.

**Reason for change:** Because EPA has approved the final aquifer exemption boundary locations shown in Figures 2a and 2b, this section has been updated to explain that if wellfield delineation drilling indicates an expansion of the aquifer exemption boundary is needed beyond the final aquifer exemption boundaries, the Permittee must submit an aquifer exemption request to the UIC Director for review and approval.

**7. Part II, Table 6: The second row in Table 6 under Part II, Section E.1 has been updated.**

**Draft language:**

Type of Test	Purpose	Timing
Water sample collection and analysis for all pump test wells	<ul style="list-style-type: none"> <li>• To identify any potential areas of leakage across confining zones due to improperly plugged boreholes or wells or naturally occurring features such as fractures.</li> <li>• To begin establishing baseline water quality in monitoring wells.</li> </ul>	Prior to initiation of pump testing activities

**Final language:**

Type of Test	Purpose	Timing
<b>Sampling and Analysis of Injection Interval and Non-injection Interval Monitoring Wells</b>	<ul style="list-style-type: none"> <li>• To identify any potential areas of leakage across confining zones due to improperly plugged boreholes or wells or naturally occurring features such as fractures.</li> <li>• <b>To determine concentrations of water quality parameters in Table 8.</b></li> </ul>	Prior to initiation of pump testing activities <b>per Section E.2.b of this Part.</b>

**Reasons for change:** EPA updated the first column to include *Sampling and Analysis of Injection Interval and Non-injection Interval Monitoring Wells* and the third column to include *per Section E.2.b of this Part*. These changes are consistent with related updates to groundwater sampling requirements in Part IV that reference this updated requirement.

In the second column, EPA replaced “baseline” with “*water quality*,” consistent with EPA’s clarifications about the baseline vs. water quality sampling concepts discussed in the Response #21 in the *Response to Comments* section of this document.

**8. Locations where “baseline” used with reference to water quality has been replaced or deleted:**

<b>Permit section</b>	<b>Change made</b>
Part II, Section E.2.b.iii	“baseline” deleted
Part II, Table 8	“baseline” deleted in Table 8 title
Part XI, Section B.1, Table 14 E, <i>Monthly Analyze</i>	“baseline” deleted and replaced with “water quality”
Part XI, Section B.1, Table 14 G, <i>Quarterly, Analyze</i>	“baseline” deleted and replaced with “excursion parameters” as explained under change #78 to the Class III Permit below in this section.
Part XI, Section B.2	This requirement to collect water quality data from all wellfield monitoring wells has been removed because it is duplicative of the requirement under Part II, Section E.2.b
Part XI, Section B.2.a.iii (formerly Section B.3.a.iii)	“baseline” deleted and replaced with “analytes”
Part XI, Section B.2.c.iv (formerly Section B.3.c.iv)	“baseline” deleted

**Reason for change:** When used in relation to water quality parameter concentrations, the term “baseline” has been replaced throughout the Class III Area Permit by more appropriate terms to be consistent with the fact that EPA does not establish any water quality standards inside the aquifer exemption area and does not regulate groundwater restoration.

**9. Part II, Section E.2.b:**

**Draft language:** None

**Final language:**

Sampling and analysis of groundwater from all wellfield injection interval and non-injection interval monitoring wells is required to obtain background concentration data for each aquifer. This data is needed to provide pre-operational groundwater quality data for the Conceptual Site Model as required under Part IV, Section A and to provide groundwater quality data in the injection zone downgradient from the wellfield for comparison with the Table B-1 permit limits.

**Reason for change:** An introductory paragraph has been to the section to provide context for the subsequent requirements for *Sampling and Analysis of Injection Interval and Non-injection Interval Monitoring Wells* and to explain the purpose of the requirements to sample and analyze groundwater.

**10. Part II, Section E.2.b.i:**

**Draft language:**

After the construction and development of the wellfield perimeter monitoring wells completed within the injection interval and the monitoring wells completed in aquifers above and below (where applicable) the injection interval, the Permittee shall collect groundwater samples from each well according to the following procedures:

**Final language:**

After the construction and development of the wellfield perimeter monitoring wells, the wellfield

injection interval wells used to determine Commission-approved background and the monitoring wells completed in aquifers above and below (where applicable) the injection interval, the Permittee must collect groundwater samples from each of these wells according to the following procedures:

**Reason for change:** The requirement to collect initial groundwater samples from the wellfield injection interval wells used to determine Commission-approved background has been added for the purpose of characterizing background groundwater chemistry of the wellfield prior to initiating ISR operations. The requirement to sample these specific wells was included for consistency with NRC requirements.

**11. Table 7:**

**Draft Permit Table:**

**Table 7. Field Parameters to be Monitored and Stabilization Criteria to Meet before Sample Collection**

Parameter	Stabilization Criteria
pH	± 10% pH units
Specific conductance	± 10% µS/cm
Temperature	± 10% °C

**Final Permit Table:**

**Table 7. Field Parameters to be Monitored and Stabilization Criteria to Meet before Sample Collection**

Parameter	Stabilization Criteria
pH	± 0.1 pH units
Specific conductance	± 3% µmhos/cm at 25 °C
Temperature	± 0.5°C
Dissolved oxygen	+ 0.3 mg/L

**Reason for change:** EPA received a number of comments on the importance of collecting groundwater quality data to support geochemical model development and the uncertainty of modeling results. EPA also received comments from Powertech, including several questions and requests for clarification of Part IV permit requirements and comments about unnecessary requirements for data collection and model development. In considering these comments, EPA re-evaluated the data collection requirements for the Conceptual Site Model under Part IV, Section A, and groundwater sampling requirements under Part IV, Section C to strengthen requirements that improve modeling results and identify requirements that were not needed for the ultimate goal of evaluating the potential for ISR contaminants to cross the aquifer exemption boundary. EPA updated the stabilization criteria included in Table 7 to ensure collection of representative samples and to improve the reliability of data for parameters that influence uranium mobility results in geochemical models. For example, geochemical modeling results for uranium transport are sensitive to variation in pH. EPA determined that a variation within + 0.1 pH units is more appropriate than ± 10% pH units. Modeling results for uranium transport are also sensitive to dissolved oxygen, so EPA added dissolved oxygen to the list of stabilization criteria.

**12. Part II, Section E.2.b.iv. and v:**

**Draft language: none**

**Final language:**

- iv. The Permittee must compare analytical results from samples collected from the downgradient wellfield perimeter monitoring-ring wells for ISR constituents listed in Table B-1 in Appendix B of this Permit. If naturally occurring background concentrations for any constituent exceed the permit limit listed in Table B-1, the Permittee must determine the background concentration to use as the alternate permit limit based on analytical results from the perimeter monitoring wells on the downgradient side of the wellfield.
- v. The Permittee must develop a brief report that includes the analytical results and a description of statistical methods used for computing the background concentration for each constituent for which a background concentration is required and include the report in the Injection Authorization Data Package Reports per Part II, Section H.3.x for review and approval.

**Reason for change:** Powertech raised concerns about the geochemical modeling requirements and the standards it must meet at the aquifer exemption boundary. See Comment #73 in the *Response to Comments* section of this document. Consideration of this comment led EPA to add MCL and health-based permit limits in Appendix B, Table B-1. Some of the constituents have background concentrations that are higher than the health-based permit limits; in these cases, EPA will allow the background levels to serve as the permit limit. These new requirements provide instruction on how the Permittee must determine baseline.

**13. Part II, Section E.2.b.vi:**

**Draft language: none**

**Final language:**

- vi. Requirements related to groundwater sample analysis for radium-228: If radium 228 is not detected in the initial sample from each well, radium-228 may be removed from the analyte list for remaining sampling and analysis events. However, if radium-228 is detected in the first sample, it must remain on the analyte list for future samples collected from that well.

**Reason for change:** Powertech requested that EPA remove radium-228 from the Table 8 list of analytes because it is not a daughter product of uranium radioactive decay. EPA agrees that radium-228 is a daughter product in the radioactive decay chain of thorium-232, and therefore, radium-228 is not expected to be found in association with uranium deposits. However, radium-228 was detected in one well (although below the MCL). With the occurrence of radium-228 in one sample and the small sampling population of six groundwater samples, EPA was not able conclude that further analysis for radium-228 was unnecessary. Therefore, EPA retained radium-288 in Table 8 with the provisions included under Part II, Section E.2.b.vi (and Part IX, Section B.3.a and b, in the first sample before groundwater restoration begins) but added this provision allowing the permittee to remove it from future sampling and analysis if it is not detected in the initial well sample.

**14. Table 8:**

**Draft language:** Baseline Water Quality Parameter List

**Final language:** Water Quality Parameter List

**Reason for change:** The title for Table 8 has been changed to remove the word “Baseline” because the list of analytes in Table 8 apply to more than just baseline analysis.

**15. Table 8:**

**Draft language:** Specific Gravity

**Final language:** none

**Reason for change:** Powertech requested that EPA remove specific gravity from the Table 8 list of analytes for water quality analysis. EPA determined that specific gravity isn’t needed for geochemical model development. Therefore, EPA removed specific gravity from Table 8 in response to this comment.

**16. Table 8:**

**Draft language:** Groundwater quality parameters related to mobility of uranium and other metals

**Final language:** none

**Reason for change:** It has been removed from Table 8 because it is no longer applicable given the reorganization of some of the analytes listed in Table 8.

**17. Table 8:**

**Draft language:**

Groundwater-quality parameters related to mobility of uranium and other metals		
Temperature	°C	2014 EPA Region 4 SOP (Temperature)
Dissolved Oxygen	mg/L	<a href="#">2017 EPA Region 4 SOP (DO)</a>

**Final language:**

Field-Measured Parameters		
Temperature**	°C	<a href="#">2018 EPA Region 4 SOP (Temperature)</a>
Dissolved Oxygen**	mg/L	<a href="#">2017 EPA Region 4 SOP (DO)</a>

**Reason for change:** EPA added these Table 8 footnotes to highlight that temperature and dissolved oxygen are to be measured in the field only. This change is related to the discussion of stabilization criteria in Table 7 in #11 above. Because the Table 8 subdivision heading *Groundwater quality parameters related to mobility of uranium and other metals*, Temperature and Dissolved Oxygen are now under a new subdivision heading *Field-Measured Parameters* consistent with the new Table 8 footnotes added for these parameters. EPA Region 4 updated the SOP for Field Temperature Measurement on March 14, 2018; this update is reflected in the third column of the table.

**18. Table 8:**

**Draft language:** Oxidation-Reduction Potential

**Final language:** none

**Reason for change:** Powertech requested that EPA remove oxidation-reduction potential (ORP) from the list analytes for water quality analysis in Table 8. As discussed under Change #22 to the Class III Permit below, EPA has added analyses for total iron and ferrous iron to provide a better method for determining the oxidative state of groundwater for the purposes of the geochemical model. Therefore, EPA removed ORP from Table 8 in response to this comment.

**19. Table 8:**

**Draft Language:**

Total alkalinity (as Ca CO<sub>3</sub>)

Bicarbonate Alkalinity (as Ca CO<sub>3</sub>)

Carbonate Alkalinity (as Ca CO<sub>3</sub>)

**Final Language:**

Total Alkalinity (as CaCO<sub>3</sub>)\*

Bicarbonate Alkalinity (as CaCO<sub>3</sub>)\*

Carbonate Alkalinity (as CaCO<sub>3</sub>)\*

**Reason for Change:** Based on numerous comments, EPA re-evaluated the data collection requirements for the Conceptual Site Model under Part IV, Section A, and groundwater sampling requirements under Part IV, Section C in response to comments about the importance of groundwater quality data. EPA identified a number of improvements to help assure that groundwater data meet data quality objectives for geochemical model development. Modeling of uranium mobility is sensitive to total alkalinity, bicarbonate alkalinity and carbonate alkalinity. Therefore, EPA added these Table 8 footnotes specifying that these parameters are to be measured in the field as well as in the laboratory in order to improve data quality and the reliability of reactive transport modeling results.

**20. Table 8:**

**Draft Language:**

Groundwater-quality parameters related to mobility of uranium and other metals		
Temperature	°C	2014 EPA Region 4 SOP (Temperature)
Dissolved Oxygen	mg/L	<a href="#">2017 EPA Region 4 SOP (DO)</a>
Oxidation-Reduction Potential	millivolts (mV)	<a href="#">2017 EPA Region 4 SOP (ORP)</a>
Carbon Dioxide	mg/L	
Total Organic Carbon	mg/L	415.3, 9060A
Dissolved Organic Carbon	mg/L	415.3, 9060A



**Final Language:**

<b>Common Elements and Ions</b>		
Carbon Dioxide	Convert mg/L to atm	A4500-CO2
Total Organic Carbon	mg/L	415.3, 9060A
Dissolved Organic Carbon	mg/L	415.3, 9060A
Total alkalinity (as CaCO <sub>3</sub> )*	mg/L	A2320B
Bicarbonate Alkalinity (as CaCO <sub>3</sub> )*	mg/L	A2320B (as HCO <sub>3</sub> )

**Reason for Change:** Because the Table 8 subdivision heading *Groundwater quality parameters related to mobility of uranium and other metals* has been removed as discussed under Change #16 to the Class III Permit above, Carbon Dioxide, Total Organic Carbon and Dissolved Organic Carbon are now included under the subdivision heading *Common Elements and Ions*.

The analytical method for carbon dioxide was omitted from the second draft permit. Because EPA has determined that it is important to specify analytical methods in order to achieve data quality objectives, the analytical method for carbon dioxide "A4500-CO2" has been included in Table 8 along with a note in the unit of measure column to convert mg/L to atmospheres (atm).

**21. Table 8:**

**Draft Language:**

Silica, as Si	mg/L	E200.7
---------------	------	--------

**Final Language:**

Silica, as SiO <sub>2</sub>	mg/L	E200.7
-----------------------------	------	--------

**Reason for Change:** EPA has clarified that silica is to be reported as SiO<sub>2</sub> to be consistent with EPA analytical method E200.7.

**22. Table 8:**

**Draft Language:**

<b>Dissolved Metals!!~~</b>		
Arsenic, As	mg/L	E200.8
Barium, Ba	mg/L	E200.8
Boron, B	mg/L	E200.7
Cadmium, Cd	mg/L	E200.8
Chromium, Cr	mg/L	E200.8
Copper, Cu	mg/L	E200.8
Fluoride, F	mg/L	E300.0
<b>Iron, Fe</b>	mg/L	E200.7
Lead, Pb	mg/L	E200.8
Manganese, Mn	mg/L	E200.8
Mercury, Hg	mg/L	E200.8
Molybdenum, Mo	mg/L	E200.8

Nickel, Ni	mg/L	E200.8
Selenium, Se	mg/L	E200.8, A3114 B
Silver, Ag	mg/L	E200.8
Uranium, U	mg/L	E200.7, E200.8
Vanadium, V	mg/L	E200.7, E200.8
Zinc, Zn	mg/L	E200.8

**Final Language:**

<b>Dissolved Metals</b>		
<b>Aluminum, Al</b>	mg/L	E200.7, E200.8, E200.9
<b>Antimony, Sb</b>	mg/L	E200.8
Arsenic, As	mg/L	E200.8
Barium, Ba	mg/L	E200.8
<b>Beryllium, Be</b>	mg/L	E200.8
Boron, B	mg/L	E200.7
Cadmium, Cd	mg/L	E200.8
Chromium, Cr	mg/L	E200.8
Copper, Cu	mg/L	E200.8
Fluoride, F	mg/L	E300.0
<b>Total Iron, Fe</b>	mg/L	E200.7
<b>Ferrous Iron, (Fe<sup>2+</sup>)</b>	mg/L	Titration with Dichromate
Lead, Pb	mg/L	E200.8
Manganese, Mn	mg/L	E200.8
Mercury, Hg	mg/L	E200.8
Molybdenum, Mo	mg/L	E200.8
Nickel, Ni	mg/L	E200.8
Selenium, Se	mg/L	E200.8, A3114 B
Silver, Ag	mg/L	E200.8
<b>Strontium, Sr</b>	mg/L	E200.8
Uranium, U	mg/L	E200.7, E200.8
<b>Thallium, Tl</b>	mg/L	E200.8
Vanadium, V	mg/L	E200.7, E200.8
Zinc, Zn	mg/L	E200.8

**Reason for Change:** *Aluminum* has been added to the list of dissolved metals in Table 8, *Water Quality Parameter List* because it is needed for geochemical model development.

Related to the inclusion of Appendix B, Table B-1 permit limits discussed under #12 above, *Antimony*, *Beryllium*, *Strontium* and *Thallium* have been added to Table 8 because these metals have primary drinking water standards, also known as maximum contaminant limits (MCLs).

Iron has been removed from Table 8 and replaced by *total Iron* and *ferrous Iron (Fe<sup>2+</sup>)* to provide information about the groundwater oxidation state, which is important to development of the

geochemical models and evaluating the potential for uranium mobility. With the removal of oxidation-reduction potential from Table 8, as discussed under #18 above, analysis of total and ferrous iron provides a better alternative method for determining the groundwater oxidation state. This change is also related to EPA's re-evaluation of the data collection requirements for the Conceptual Site Model under Part IV, Section A, and groundwater sampling requirements under Part IV, Section C in response to comments discussed under Change #11 to the Class III Permit above.

### 23. Part II, Section G:

**Draft language:**

G. Additional Requirements to Obtain Authorization to Commence Injection for Burdock Wellfields 6, 7 and 8

**Final language:**

G. Additional Requirements to Obtain Approval of Exemption of Inyan Kara Aquifers and Authorization to Commence Injection for Burdock Wellfields 6, 7 and 8

**Reason for change:** The heading for Part II, Section G has been updated to include the words "**Approval of Exemption of Inyan Kara Aquifers and**" because the Final Aquifer Exemption Record of Decision does not approve the exemption of Inyan Kara aquifer in the area of Burdock Wellfields 6, 7 and 8 due to uncertainties related to the amenability of the ISR mining method in partially unsaturated portions of the Inyan Kara aquifers at the locations of Burdock Wellfields 6, 7 and 8. For additional information, see the section ***Demonstration of Amenability of Mining Method*** pages 16-17 of the Aquifer Exemption Record of Decision.

### 24. Part II, Section G.1:

**Draft language:**

1. Because the Chilson Sandstone downgradient from Burdock Wellfields 6, 7 and 8 has been partially oxidized by native groundwater, the Permittee shall evaluate the capacity of the downgradient Chilson Sandstone to **remove** residual contamination from restored wellfield groundwater as it travels downgradient toward the aquifer exemption boundary.

**Final language:**

1. Because the Chilson Sandstone downgradient from Burdock Wellfields 6, 7 and 8 has been partially oxidized by native groundwater, the Permittee must evaluate the capacity of the downgradient exempted portion of the Chilson Sandstone to attenuate residual ISR contaminants (Appendix B, Table B-1) in restored wellfield groundwater as they travel downgradient toward the aquifer exemption boundary.

**Reason for change:** Under Part II, Section G.1, the word "remove" has been replaced with "attenuate" because that is a more appropriate term. In addition, the phrase "and the potential for concentrations of ISR contaminants (Appendix B, Table B-1) to rebound as restored wellfield groundwater" has been added to reference the permit limits for potential ISR contaminants that have been included in Appendix B, Table B-1 of the final Class III Area Permit.

**25. Part II, Section G.2.a:**

**Draft language:**

2. To fulfill this requirement the Permittee shall:
  - a. Develop Conceptual Side Models for wellfields 6, 7 and 8 by conducting all the sampling and testing required for all wellfields as described under this Part.

**Final language:**

2. To fulfill this requirement the Permittee must:
  - a. Develop **preliminary** Conceptual Side Models for wellfields 6, 7 and 8 by conducting all the sampling and testing required for all wellfields as described under this Part.

**Reason for change:** The word “preliminary” has been added to distinguish this CSM specifically required for Burdock Wellfields 6, 7 and 8 from the updated CSM required in Part IV.

**26. Part II, Section G.2.b:**

**Draft language:**

In addition, the Permittee shall expand the Conceptual Site Model for wellfields 6, 7 and 8 by collecting samples from the downgradient injection interval for the purposes of characterizing the geochemistry of the downgradient injection interval.

**Final language:**

In addition, the Permittee must expand the Conceptual Site Model for wellfields 6, 7 and 8 by **characterizing the geology, hydrologic properties, and geochemical characteristics and processes as described under Part IV, Section A.**

**Reason for change:** EPA revised the text in this requirement to be consistent with changes to the Conceptual Site Model requirements under Part IV, Section A. The over-arching reasons for EPA’s changes to Part IV are discussed in Change #40 to the Class III Permit below.

**27. Part II, Section G.2.c:**

**Draft language:**

In addition, the Permittee shall further expand the Conceptual Site Model for wellfields 6, 7 and 8 by conducting column testing, batch sorption testing, or other appropriate laboratory and field testing methods to provide site-specific inputs into the geochemical model, as specified in Part IV, Section C.

**Final language:**

In addition, the Permittee must further expand the Conceptual Site Model for wellfields 6, 7 and 8 by conducting batch sorption testing or other appropriate laboratory and field testing methods to provide site-specific sorption parameters for input into the geochemical model, as specified in Part IV, Section C.

**Reason for change:** EPA removed the column testing requirement from this section as a result of the reevaluation of Part IV requirements discussed under Change #40 to the Class III Permit below. Column testing requirements have been consolidated under Part IV, Section C with other laboratory testing requirements.

**28. Part II, Section G.2.d:**

**Draft language:** none

**Final language:**

- d. Because preliminary Conceptual Site Models for wellfields 6, 7 and 8 must be developed prior to obtaining approval of the exemption of Inyan Kara aquifers and authorization to commence injection, geochemical conditions representing the restored wellfield may be estimated based on data from similar restored wellfields.

**Reason for change:** During EPA's reevaluation of field data collection requirements, EPA determined that because preliminary Conceptual Site Models for wellfields 6, 7 and 8 must be developed prior to obtaining approval of the exemption of Inyan Kara aquifers and authorization to commence injection, it would be prudent to explicitly include a new provision under Part II, Section G.2, to explain that geochemical conditions representing the restored wellfield may be estimated on the basis of data from similar wellfields.

**29. Part II, Section G.2.e:**

**Draft language:**

- d. The Permittee shall calibrate the geochemical model using analytical data from field and laboratory testing as specified in Part IV, Section B.5.

**Final language:**

- e. **On the basis of data collected under this Part, develop preliminary reactive-transport geochemical models for wellfields 6, 7 and 8 as specified in Part IV, Section B to evaluate the potential for ISR contaminants to cross the aquifer exemption boundary.** The Permittee must calibrate the geochemical models using analytical data from field and laboratory testing as specified in Part IV, Section B.5. **and conduct uncertainty analysis** as specified in Part IV, Section B.6.

**Reason for change:** Former requirement Part II, Section G.2.d is now G.2.e and has been updated to be consistent with and include reference to updated requirements under Part IV, Section B.

**30. Part II, Section G.5:**

**Draft language:**

5. If the aquifer exemption for Burdock Wellfields 6 and 7 has not been approved upon issuance of this Final Area Permit, the results from these additional requirements for Burdock Wellfield 6 and 7 shall be submitted to the Director as part of the aquifer exemption request.

**Final language:**

5. The results from these additional requirements for Burdock Wellfield 6, 7 and 8 must be submitted to the Director as part of the aquifer exemption request.

**Reason for change:** The final AE decision does not approve the exemption of Inyan Kara aquifer in the area of Burdock Wellfields 6, 7 and 8 because of the uncertainty caused by partially saturated conditions in the areas of Burdock Wellfields 6, 7 and 8 (see Change #23 to the Class III Permit above). Part II, Section G.3 of Class III Area Permit now requires Powertech to perform additional

wellfield pump testing, and possibly flow modeling, to demonstrate the amenability of the Inyan Kara aquifers to the ISR process before approving the AE for these areas. EPA updated this requirement to be consistent with that AE decision and updated requirement.

**31. Part II, Section H.3.e:**

**Draft language:** none

**Final language:**

**H. Injection Authorization Data Package Reports**

3. (. . .) In summary, each Injection Authorization Data Package Report must contain the following:

(. . .)

- e. Characterization of faults, fractures, and lithologic variability that might provide preferential flow paths or otherwise affect groundwater flow.

**Reason for Change:** In response to comments received expressing concerns that the faults and fractures have not been adequately characterized within the Dewey-Burdock Project Area, EPA added new requirement **e** directing the Permittee to include this information in the Injection Authorization Data Package Reports, which EPA will review before authorizing injection into each wellfield. This requirement has also been added to be consistent with the requirement under Part IV, Section A.2.a.vi to include information about faults, fractures and lithologic variability in the Conceptual Site Model.

**32. Part II, Section H.3.x:**

**Draft language:** none

**Final language:**

- x. The report required under Part II, Section E.2.b.v that includes the analytical results from Part II, Section E.2.b.iii. and a description of statistical methods used for computing the background concentration for each constituent for which a background concentration is required.

**Reason for Change:** EPA added this new requirement, Part II, Section H.3.x, to include the report required under Part II, Section E.2.b.v in the Injection Authorization Data Package Report. The Part II, Section E.2.b.v (see Change #12 to the Class III Permit above) report includes the analytical results and a description of statistical methods used for computing the background concentration for each constituent for which a background concentration is required.

**33. Part II, Section I.2.b:**

**Draft language:**

- b. No injection into Burdock Wellfields 6 and 7 will be authorized until after the Aquifer Exemption of Inyan Kara groundwater in that area has been approved by the Director.

**Final language:**

- b. No injection into Burdock Wellfields 6, 7 **and 8** will be authorized until after the Aquifer Exemption of Inyan Kara groundwater in that area has been approved by the Director.

**Reason for Change:** EPA updated Part II, Section I.2.b to include Burdock Wellfield 8, along with Burdock Wellfields 6 and 7, in the requirement prohibiting injection until after approval of the exemption of Inyan Kara aquifers at these wellfields. Previously, the exemption of Burdock Wellfields 6 and 7 was in question because of Well 16, which is located within Burdock Wellfields 6 and 7 and was previously used as a drinking water well. Because the Final Aquifer Exemption Record of Decision does not approve exemption of Inyan Kara aquifers at Burdock Wellfield 8 (see Change #23 above to the Class III Permit), the requirement under Part II, Section I.2.b also applies to Wellfield 8.

**34. Part II, Section I.3:**

**Draft language:**

3. Information to Submit to the Director to Obtain Approval of the Exemption of Inyan Kara Aquifers within the Proposed Aquifer Exemption Boundary around Burdock Wellfields 6 and 7.

**Final language:**

3. Information on Well 16 to Submit to the Director to Obtain Approval of the Exemption of Inyan Kara Aquifers for Burdock Wellfields 6 and 7.

**Reason for Change:** EPA has changed the heading for Part II, Section I.3 omitting *within the Proposed Aquifer Exemption Boundary*. EPA's final AE decision excludes Burdock Wellfields 6 and 7; therefore, they are not within the AE boundary.

**35. Part II, Section I.3:**

**Draft language:**

If the Permittee has not demonstrated to the Director that Well 16 located in NWSE Section 1 T7S R1E does not currently serve as a source of drinking water before issuance of the Final Class III Area Permit, the Permittee shall submit the following information to the Director for proposing exemption of the Inyan Kara aquifer within the proposed exemption boundary:

- a. Injection Authorization Data Package Reports including all the information under Part II, Sections B through G and Section I. This information will serve as additional analysis of the amenability of the injection interval to the in-situ method for uranium recovery as required under § 144.7(c)(1).
- b. A demonstration that Well 16 located in NWSE Section 1 T7S R1E does not currently serve as a source of drinking water.

**Final language:**

The Permittee must submit documentation to the South Dakota Water Rights Program to reclassify well 16 located in NWSE Section 1, T7S, R1E as a monitoring well. Documentation must include a statement that: 1) well 16 should not be used for human consumption because the groundwater produced from the well exceeds the primary drinking water standards for radium and gross alpha and 2) groundwater radon levels are high enough that indoor use of that groundwater should be avoided.

**Reason for Change:** Section I.3 previously included requirements related to Well 16, which was a domestic well for a private residence. Because EPA did not approve exemption of the portion of the

Inyan Kara aquifers in the areas of Burdock Wellfields 6 and 7 where Well 16 is located, there is no need to retain these requirements in the Final Class III Area Permit. EPA updated the requirements to provide guidance to the Permittee regarding appropriate documentation for Well 16 in any future aquifer exemption requests for Burdock Wellfield 6 and 7.

### **36. Part II, Section K:**

#### **Draft Language:**

##### **K. Plugging and Abandonment of Wellfield Wells**

If evaluation of the Injection Authorization Data Package Reports indicate the hydrogeologic conditions are not conducive to the in-situ recovery of uranium, the Director will not issue Authorization to Commence Injection and the Permittee must plug and abandon all wellfield wells according to the requirements under Part XI of this Area Permit.

#### **Final Language:**

##### **K. Plugging and Abandonment of Wellfield Wells**

If evaluation of the Injection Authorization Data Package Reports as described under Section I of this Part indicate the hydrogeologic conditions are not conducive to the in-situ recovery of uranium, the Director will not issue Authorization to Commence Injection and the Permittee must plug and abandon all wellfield wells according to the requirements under Part XI of this Area Permit.

**Reason for Change:** In order to add more transparency about EPA's decision criteria for issuing authorization to inject into each ISR wellfield, EPA clarified that determining if hydrogeologic conditions are not conducive to the in-situ recovery of uranium will be based on evaluations described under Part II Section I of the Class III Area Permit. This change is in response to Comment #36, which expressed concern that the public will not have the opportunity to review and provide comments on the Injection Authorization Data Package Report data.

### **37. Part III.A.4:**

**Draft language:** none

#### **Final language:**

4. The Permittee must install locking wellhead covers on private wells under the Permittee's control within the Project Area to ensure that only the Permittee and authorized representatives have access to these wells.

**Reason for Change:** EPA added new requirement 4 under *Correction Action for Water Supply Wells near Wellfields* for securing access to any private wells Powertech brought under Powertech's control. Based on consideration of several comments expressing concern about ISR contaminants migrating outside the wellfield areas, EPA determined that it is important to limit the access to private wells because any pumping of private wells could interfere with the inward hydraulic gradient that is required under the Class III Area Permit to maintain lateral control of injected lixiviant.

### **38. Part III.B and C:**



**Draft Language:**

**B. Wellfield Delineation Drilling and Pump Testing**

6. If vertical excursion cannot be controlled in the area around a breach that cannot be located or remediated with corrective action because operational controls are not effective, the Permittee shall be prohibited from injection activity in this location.
7. The Permittee shall remediate any vertical excursions that have occurred in the area around a breach that cannot be located or remediated.
8. Excursion monitoring shall continue in the area where around a breach that cannot be located or remediated with corrective action even though there is no longer any injection activity occurring.

**Final Language:**

**C. ISR Operations**

1. If vertical excursion cannot be controlled in the area around a breach that cannot be located or remediated with corrective action because operational controls are not effective, the Permittee must be prohibited from injection activity in this location.
2. The Permittee must remediate any vertical excursions that have occurred in the area around a breach that cannot be located or remediated.
3. Excursion monitoring must continue in the area where around a breach that cannot be located or remediated with corrective action even though there is no longer any injection activity occurring.

**Reason for Change:** This change is in response to a comment from Powertech requesting that these requirements be removed from Part III, Corrective Action requirements. Powertech stated that these requirements relate to vertical excursions, which are discussed in Part IX, Section C. *Excursion Monitoring*, where monitoring is required during ISR operations and groundwater restoration but not during wellfield delineation drilling and pump testing.

These changes are indeed related to corrective action and should be retained in the final Class III Area Permit under the Corrective Action section. See 40 CFR § 144.55(b)(4). However, EPA agrees that this would not occur during wellfield delineation and pump testing. EPA has added another heading C. under Part III, Corrective Action entitled *ISR Operations* and included these requirements under this heading, since any vertical excursions would be discovered during ISR Operations.

**39. Part IV:**

**Draft language:**

PART IV. REQUIREMENTS FOR DEVELOPMENT OF A CONCEPTUAL SITE MODEL AND A REACTIVE TRANSPORT GEOCHEMICAL MODEL

**Final language:**

PART IV. REQUIREMENTS FOR DEVELOPMENT OF CONCEPTUAL SITE MODEL AND REACTIVE TRANSPORT GEOCHEMICAL MODELING

**Reason for Change:** EPA received a number of comments on the importance of collecting groundwater quality data to support geochemical model development and the uncertainty of modeling results. EPA also received comments from Powertech, including several questions and requests for clarification of Part IV permit requirements and comments about unnecessary

requirements for data collection and model development. In consideration of these comments, EPA reviewed additional scientific information and consulted with modeling experts from the NRC and re-evaluated requirements for the Conceptual Site Model under Part IV, Section A, modeling requirements under Part IV, Section B, and data collection requirements under Part IV, Section C, resulting in a number of changes. The changes to these requirements strengthen and clarify permit conditions to improve modeling results and remove those conditions that were not needed for the ultimate goal of evaluating the potential for ISR contaminants to cross the aquifer exemption boundary.

EPA modified the title of Part IV slightly to reflect that fact that more than one geochemical model will be required under this part.

#### **40. Part IV, Section A:**

##### **Draft language:**

###### **A. Development of a Conceptual Site Model**

The Permittee shall develop a Conceptual Site Model (CSM) for the purpose of supporting a reactive transport geochemical model to evaluate the potential for ISR contaminants to cross the aquifer exemption boundary. Development of the CSM will include the information already available in the Class III Permit Application and the information required under Part II, Section H as part of the Injection Authorization Data Package Reports. A complete representation of the geology, hydrologic properties, and geochemical characteristics and processes of the site is necessary to enable the reactive transport model to make accurate predictions concerning the potential for ISR contaminants to cross the aquifer exemption boundary.

This information will become part of the Wellfield Closure Plan for all ISR wellfields, except for Burdock Wellfields 6, 7, and 8. Part II Section G, requires development of a CSM and geochemical model as part of the Injection Authorization Data Package Reports for these wellfields.

##### **Final language:**

###### **A. Development of a Conceptual Site Model**

The Permittee must develop a Conceptual Site Model (CSM) for the purpose of supporting reactive transport geochemical modeling to evaluate the potential for ISR contaminants to cross the aquifer exemption boundary. The constituents considered to be ISR contaminants under this Area Permit are listed in Appendix B, Table B-1. Development of the CSM will include the information already available in the Class III Permit Application, the information required under Part II, Section H for each wellfield as part of the Injection Authorization Data Package Reports, and additional information required for geochemical modeling described in this Part. A complete representation of the geology, hydrologic properties, and geochemical characteristics and processes for each wellfield is necessary to minimize uncertainty of model predictions concerning the potential for ISR contaminants to cross the aquifer exemption boundary.

This information will become part of the Wellfield Closure Plan for all ISR wellfields. With the exception of the preliminary CSMs developed for Burdock Wellfields 6, 7, and 8 under Part II Section

G, a CSM is not required as part of the Injection Authorization Data Package Report unless site-specific data indicate oxidizing conditions downgradient from the wellfield.

**Reason for Change:** These changes were made to be consistent with the changes to the Conceptual Site Model, explained in Change #40 to the Class III Permit above.

**41. Part IV, Section A.1:**

**Draft language:** none

**Final language:**

1. The extent of the CSM for geochemical modeling must encompass an area sufficient to characterize flow paths across each wellfield injection interval, including:
  - a. Upgradient of wellfields,
  - b. Within wellfields,
  - c. Downgradient of wellfields within the aquifer exemption boundary, and
  - d. Margin beyond the downgradient aquifer-exemption boundary sufficient to protect USDWs.

**Reason for Change:** EPA added these requirements in response to comments expressing concern about the validity of relying on a geochemical model. See Change #40 to the Class III Permit above.

**42. Part IV, Section A.2.a.v (formerly Section A.1.a.v):**

**Draft language:**

- v. Maps showing the areal extent, continuity, and thickness of localized confining layers within the wellfield injection interval.

**Final language:**

- v. Characterization of localized confining layers that could affect groundwater flow paths and transport of ISR contaminants toward the aquifer exemption boundary.

**Reason for Change:** EPA updated this requirement to provide characterization instead of maps showing the localized confining layers that could affect groundwater flow paths and transport of ISR contaminants toward the aquifer exemption boundary. The change was a result of EPA's reevaluation of Part IV requirements to focus on information directly pertinent to evaluating the potential for ISR contaminants to cross the aquifer exemption boundary. See Change #40 to the Class III Permit above.

**43. Part IV, Section A.2.a.vi (formerly Section A.1.a.vi):**

**Draft language:**

- vi. Characterization of faults, fractures, and lithologic variability that might provide pathways for preferential flow or otherwise affect groundwater flow.

**Final language:**

- vi. Characterization of faults, fractures, and lithologic variability that might provide pathways for preferential flow or otherwise affect groundwater flow.

**Reason for Change:** EPA removed the phrase “related to depositional history” from this requirement to be more inclusive, because faults and fractures can also result from tectonic activities. The change was a result of EPA’s reevaluation of Part IV requirement to focus on and accurately describe CSM requirements. See Change #40 to the Class III Permit above.

**44. Part IV, Section A.2.a.vii:**

**Draft language:**

vii. Petrologic and mineralogic characteristics that can affect hydraulic and geochemical properties of the injection interval and confining zones, such as grain size, cementation, overgrowths, and nodules.

**Final language:** none

**Reason for Change:** After reevaluation of Part IV, Part A requirements for CSMs, EPA deleted this requirement from this section. This requirement is retained in the section about characterization of solid-phase geochemistry under Part IV, Section A.2.c.ii.B (formerly Section A.1.c.ii.B) where it fits more appropriately. See Change #50 to the Class III Permit below.

**Part IV, Section A.2.b:**

**Draft language:**

- i. For each wellfield injection interval and the first confining zones overlying and underlying the injection interval, the CSM shall include, but not be limited to, site-specific data concerning:
- A) Porosity;
  - B) Intrinsic permeability (horizontal and vertical); and
  - C) Vertical hydraulic conductivity.

**Final language:** none

**Reason for Change:** EPA deleted this requirement from this section after reevaluation of CSM requirements to focus on information directly pertinent to the potential for ISR contaminants to cross the aquifer exemption boundary. See Change #40 to the Class III Permit above. Characterization of aquifer porosity for each wellfield injection interval has been retained in Section A.2.b.ii as described in Change #47 to the Class III Permit below.

**45. Part IV, Section A.2.b (formerly Section A.1.b.ii):**

**Draft language:**

- ii. For each wellfield injection interval, the CSM also shall include site-specific data to assess:
- A) Horizontal hydraulic conductivity, transmissivity, and storativity;
  - B) Aquifer heterogeneity and anisotropy;
  - C) Potentiometric surface representing static conditions prior to injection activities;
  - D) Potentiometric surface representing conditions after the effects of injection and restoration have stabilized;
  - E) Transient hydraulic-head conditions during injection activities;

- F) Groundwater velocities;
- G) Aquifer confinement and hydraulic connection to overlying and underlying aquifers; and
- H) Areas of aquifer recharge and discharge.

**Final language:**

b. Hydrologic Properties

For each injection interval, the CSM must include site-specific data to assess:

- i. Aquifer hydraulic conductivity, transmissivity, and storativity;
- ii. Aquifer porosity;
- iii. Aquifer heterogeneity and anisotropy;
- iv. Potentiometric surface representing static conditions prior to injection activities;
- v. Potentiometric surface representing stabilized post-restoration conditions;
- vi. Groundwater velocities; and
- vii. Aquifer confinement and hydraulic connection to overlying and underlying aquifers.

**Reason for Change:** As a result of EPA reevaluation of CSM requirements, this section has been pared down and re-worked to include only the injection interval properties essential for the CSM. See Change #40 to the Class III Permit above. Former sections E) *Transient hydraulic-head conditions during injection activities* and H) *Areas of aquifer recharge and discharge* have been deleted because EPA has determined that this information is not required for modeling a confined aquifer system, such as the Inyan Kara aquifers.

**46. Part IV, Section A.2.c:**

**Draft language:**

Because results of reactive transport modeling are sensitive to geochemical input parameters, very accurate characterization of aquifer geochemistry is required. To accomplish this, geochemical characterization shall include data representative of pre-operational (baseline), groundwater restoration and restoration stability monitoring phases. Data shall represent characteristics of each injection interval across the wellfield and areas upgradient and downgradient of the wellfield.

**Final language:**

Because results of reactive transport modeling are sensitive to geochemical input parameters, site-specific characterization of aquifer geochemistry is required.

**Reason for Change:** EPA has updated the introductory paragraph of Part IV, Section A.2.c under the section describing the requirements for CSM *Geochemical Characteristics* to reflect the removal of the requirement to model wellfield groundwater restoration and restoration stability monitoring lifecycle phases. See Change #40 to the Class III Permit above.

**47. Part IV, Section A.2.c.i:**

**Draft language:**

- i. Characterization of aqueous geochemistry for the CSM shall include analysis of the following:
  - A) Groundwater-quality parameters listed in Table 8;
  - B) Chemistry of restoration fluids;
  - C) Chemistry of wellfield fluids during the restoration stability monitoring phase;

- D) Potential for colloid-facilitated transport of uranium and other metals. This can be assessed by separation of colloidal and dissolved uranium fractions by ultrafiltration on a subset of samples; and
- E) Groundwater geochemistry representative of the full project area and range of conditions, including the wellfield and areas upgradient and downgradient of the wellfield.

**Final language:**

- i. Characterization of aqueous geochemistry for the CSM must include analysis of the following:
  - A) Groundwater representing background conditions within, upgradient, and downgradient of each wellfield for parameters listed in Table 8;
  - B) Injection fluids for analytes listed in Table 15; and
  - C) Groundwater representing post-restoration stability conditions within each wellfield for parameters listed in Table 8.

**Reason for Change:** EPA revised the introductory paragraph for this section and the requirements under Part IV, Section A.2.c.i to remove requirements to characterize aqueous geochemistry representative of the full project area and range of conditions because EPA had determined that characterization of the wellfield during the groundwater restoration and post-restoration stability monitoring phases are no longer required. See Change #40 to the Class III Permit above. The requirement to assess the potential for colloid-facilitated transport of uranium and other metals has been moved to Part IV, Section A.2.d.iv as a potential geochemical process to consider based on site conditions. EPA removed the requirement to consider colloid transport from this section because it is not a likely to be important transport mechanism for uranium (Colon et al., 2001). EPA also revised A) through C) to specify the aqueous media to be sampled and which analyte list to use.

**48. Part IV, Section A.2.c.ii:**

**Draft language:**

- ii. Characterization of solid-phase geochemistry shall include:
  - A) Mineralogy representative of lithologic variations within injection intervals **and the first confining zones overlying and underlying the injection interval**, particularly with respect to minerals that can have a substantial effect on uranium mobility, such as calcite, clays, iron oxyhydroxides, manganese oxyhydroxides, and sulfide minerals;
  - B) Petrologic and mineralogic characteristics that can affect geochemical properties, such as bulk density, grain size, cementation, overgrowths, and nodules.
  - C) Metals for which there are drinking water standards or alternate concentration limits (ACLs) and that may be affected by geochemical and biogeochemical processes at the project site;
  - D) Consideration of microbial populations and their potential to affect uranium recovery or establish reducing conditions after restoration; and
  - E) Content of organic matter in sediment.

**Final language:**

- ii. Characterization of solid-phase geochemistry must include **evaluation of the following:**
  - A) **Quantitative** mineralogy representative of lithologic variations within injection intervals, particularly with respect to minerals that can have a substantial effect on uranium mobility,

including but not limited to calcite, clay minerals, hematite, iron oxyhydroxides, and pyrite/marcasite.

- B) Petrologic and mineralogic characteristics that can affect geochemical properties, such as bulk density, grain size, cementation, overgrowths, and nodules.
- C) Presence of metals listed in Appendix B, Table B-1 for which solubility and transport may be affected by geochemical conditions of the background aquifer or restored wellfield; and
- D) Content of organic carbon.

**Reason for Change:** EPA updated this section as a result of reevaluation of Part IV, Part A CSM requirements. See Change #40 to the Class III Permit above.

#### **49. Part IV, Section A.2.c.iii:**

**Draft language:**

Delineation of areas where groundwater geochemistry and mineralogical characteristics of the aquifer solids indicate reducing or oxidized conditions.

**Final language:**

Areas where groundwater geochemistry and mineralogical characteristics of the aquifer solids indicate reduced or oxidized conditions must be delineated.

**Reason for Change:** To be consistent with other changes under Part IV, Section A.2.c, this section was reworded to have parallel sentence structure with Part IV, Sections A.2.c.i and A.2.c.ii.

#### **50. Part IV, Section A.2.d.i.A):**

**Draft language:**

- A) Interactions between native groundwater and aquifer solids under steady-state baseline conditions.
- B) Interactions between restoration fluids and the aquifer in the wellfield during the restoration phase.

**Final language:**

- A) Interactions between native groundwater and aquifer solids under background pre-mining conditions.

**Reason for Change:** EPA revised Requirement A) to use language consistent with other parts of the permit referencing background conditions that have been updated per EPA's reevaluation of CSM requirements. Former requirement B), to determine geochemical processes occurring during the groundwater restoration phase, was removed. EPA has determined that geochemical conditions during the restoration phase are too transient to characterize accurately, and attempting to develop a geochemical model to evaluate these processes is not useful for achieving the end result of evaluating the potential for ISR contaminants to cross the aquifer exemption boundary after wellfield groundwater restoration has been completed. See Change #40 to the Class III Permit above.

**51. Part IV, Section A.2.d.ii:**

**Draft language:**

- ii. The following geochemical processes shall also be evaluated for inclusion in the CSM:
  - A) Adsorption of uranium and other metals onto iron and manganese oxyhydroxides or clay minerals.
  - B) Release of uranium and other metals from iron and manganese oxyhydroxides under reductive dissolution.
  - C) Reduced adsorption of uranium onto mineral surfaces by formation of aqueous uranyl-carbonate complexes and calcium-carbonate-uranyl complexes.
  - D) Desorption of uranium and other metals due to pH and other changes in groundwater geochemistry.
  - E) The role of competition for sorption sites from other cations and metals in controlling the retardation of uranium and other metals.
  - F) The potential for uranium and other heavy metals to be sorbed onto and transported by colloid-size particles.
  - G) Dissolution or precipitation of calcite due to changes in pH, alkalinity, and calcium content.
  - H) Redox changes driven by localized heterogeneity in organic carbon.
  - I) The immobilization of uranium by reduction of U(VI) to U(IV) and formation of low solubility uranium minerals (uraninite, pitchblende, and coffinite).
  - J) The possibility that ore-zone uranium was hydraulically bypassed by lixiviant during ISR activities because of lithologic variability and could be mobilized by post-restoration groundwater.

**Final language:**

- ii. The following geochemical processes must also be evaluated in the CSM:
  - A) Effect of aqueous uranyl-carbonate complexes and calcium-carbonate-uranyl complexes on uranium mobility.
  - B) Desorption of uranium and other metals due to pH and other changes in groundwater geochemistry.
  - C) Dissolution or precipitation of calcite due to changes in pH, alkalinity, and calcium content.
  - D) The immobilization of uranium by reduction of U(VI) to U(IV) and formation of low solubility uranium minerals (uraninite, pitchblende, and coffinite).
  - E) Stagnant groundwater zones and dual-domain porosity.
  - F) Potential effects of residual lixiviant.
  - G) The possibility that ore-zone uranium was hydraulically bypassed by lixiviant during ISR activities because of lithologic variability and could be mobilized by post-restoration groundwater.
- iii. In addition, the following geochemical processes must be evaluated in the CSM for Burdock Wellfields 6, 7, and 8 and any other wellfield found to have downgradient oxidized aquifer conditions:
  - A) Adsorption of uranium and other metals onto iron and manganese oxyhydroxides or clay



- minerals.
  - B) Release of uranium and other metals from iron and manganese oxyhydroxides under reductive dissolution.
  - C) The role of competition for sorption sites from other cations and metals in controlling the retardation of uranium and other metals.
  - D) The effect of cation exchange processes.
- iv. The following conditions and geochemical processes also must be included in the CSM for a wellfield if the Director determines that, based on site conditions, they are important to accurately simulate the transport of ISR contaminants toward the aquifer exemption boundary:
- A) Redox changes driven by localized heterogeneity in organic carbon;
  - B) Kinetic rates and rate-limited sorption;
  - C) Hydrodynamic dispersion;
  - D) Potential for uranium and other metals to be sorbed onto and transported by colloid-size particles;
  - E) Potential for microbial populations to affect geochemical conditions after restoration;
  - F) Residual effects of excursions; and
  - G) Other important geochemical processes identified during data collection and site characterization.

**Reason for Change:** As a result of EPA's reevaluation of Part IV, Part A CSM requirements, this requirement has been reorganized into three separate sections (ii-iv) to provide clarification requested by Powertech for which geochemical processes are ii) required for all CSMs, iii) required for only Burdock Wellfields 6, 7, and 8 and any other wellfield found to have downgradient oxidized aquifer conditions, and iv) required to be considered for inclusion in the CSM for all wellfields if they are identified based on site conditions as important to accurately simulating the transport of ISR contaminants toward the aquifer exemption boundary. See Change #40 to the Class III permit above.

## **52. Part IV, Section A.3:**

### **Draft language:**

2. The Conceptual Site Model shall meet the following criteria:
  - a. The CSM shall be based on data collected during initial and ongoing site-characterization activities as well as data collected specifically to evaluate geochemical conditions at the Dewey Burdock site and processes that will affect uranium mobility.
  - b. Data shall be collected from within the proposed wellfields as well as upgradient and downgradient of wellfields and shall adequately characterize aquifer heterogeneity.
  - c. The CSM shall incorporate site characteristics representative of conditions before, during, and after conducting ISR operations.
  - d. The CSM shall be based on site-specific data from groundwater samples, core analyses, laboratory batch and column tests, well logs, and other site investigations.
  - e. The areal extent of the CSM shall encompass the following:
    - i. Upgradient of the wellfield,

- ii. Wellfield,
  - iii. Downgradient of the wellfield within the aquifer exemption boundary, and
  - iv. Margin beyond the downgradient aquifer-exemption boundary.
- f. The vertical extent includes all injection intervals and the first overlying and underlying confining zones.
  - g. Sufficient data were collected to characterize heterogeneity and statistically represent variations in geologic, hydrologic, and geochemical conditions across the site.
  - h. Geochemical data spatially represent the sites necessary to identify and characterize geochemical processes at the site.
  - i. Data meet quality-assurance requirements. Water-quality analyses have a charge imbalance less than 10 percent.
  - j. Data gaps, inconsistencies, and limitations are identified and their potential impact on model results are assessed.
  - k. Water-quality analyses include all analytes presented in Table 8.
  - l. Water-quality analyses include adequate representation of uranium, other constituents having drinking-water standards or ACLs, and constituents or parameters that affect uranium mobility.
  - m. Appropriate field measurements of water-quality physical properties (pH, temperature, dissolved oxygen, oxidation-reduction potential) were made.
  - n. The oxidation state of uranium, iron, manganese, and other redox-sensitive metals are characterized in the solid phase.
  - o. Iron phases in sediment are characterized.
  - p. Geochemical processes related to uranium mobility were characterized by using laboratory or field testing.

**Final language:**

3. The Conceptual Site Model must meet the following criteria:
  - a. The CSM is based on data collected from wellfield characterization activities as well as data collected specifically to evaluate geochemical conditions and processes that will affect uranium mobility.
  - b. Data representing background groundwater chemistry and aquifer solid phases are collected from within the proposed wellfield as well as upgradient and downgradient of the wellfield as specified in Part IV, Sections C.1.a and C.2 and Part II, Section E.2.b.
  - c. Data representing groundwater chemistry and aquifer solid phases within the restored wellfield, including areas having high residual ISR contaminant concentrations, are collected as specified in Part IV, Sections C.1.b and C.2 and Part IX, Section B.4.
  - d. The CSM incorporates hydrogeologic characteristics representative of the injection interval aquifer.
  - e. The CSM is based on site-specific data from groundwater samples, core analyses, laboratory batch and/or column tests, well logs, and other appropriate laboratory and field tests, as specified in Part IV, Section C.
  - f. The areal extent of the CSM encompasses areas upgradient of wellfields, within wellfields, and downgradient of wellfields, including a margin beyond the aquifer exemption boundary sufficient to protect USDWs. The vertical extent of the CSM includes all injection intervals,

- the first overlying and underlying confining zones and aquifer units overlying and immediately underlying the confining zones, excluding those below the Morrison Formation.
- g. Sufficient data were collected to characterize heterogeneity and statistically represent variations in geologic, hydrologic, and geochemical conditions of each injection interval.
  - h. Geochemical data spatially represent the sites necessary to identify and characterize geochemical processes at the site.
  - i. Groundwater geochemical data are collected according to applicable procedures described in Part II, Section E.2.b and Part IX, Section A.
  - j. Groundwater samples are analyzed for the analytes and parameters listed in Table 8 using the specified analytical method or equivalent method with Director's approval. Water-quality analyses have a charge imbalance less than 10 percent.
  - k. Mineral assemblages and solid phases are quantitatively evaluated and laboratory tests to determine sorption properties are conducted in accordance with Part IV, Section C.3.
  - l. Data gaps, inconsistencies, and limitations are identified and their potential impact on model results are assessed.

**Reason for Change:** EPA updated Part IV, Section A.3, (formerly Section A.2) which specifies the criteria the CSM must meet as a result of evaluating Part IV, Part A CSM requirements. See Change #40 of the Class III Permit above.

### **53. Part IV, Section A.4:**

#### **Draft language:**

3. The Permittee shall update the CSM when any of the following occur:
  - a. On the basis of additional data collected during the development of each new wellfield. This iterative process will support identifying and filling data gaps over time and facilitate model calibration to observed conditions. When the Permittee identifies data gaps or uncertainty concerning geology, hydrologic properties, geochemical characteristics, and/or geochemical processes that could affect mobility and transport of uranium and other metals at the Dewey-Burdock site, the Director may require the Permittee to develop more than one CSM to accommodate and characterize the areas of uncertainty.
  - b. During groundwater restoration monitoring with data collected at a frequency sufficient to determine the success of aquifer restoration, optimize the efficiency of aquifer restoration, and determine if any areas of the wellfield require additional action, but no less frequently than once per quarter. The Permittee shall include information on evaluation of any flare zones or areas with high contaminant concentrations.
  - c. During quarterly restoration stability monitoring, including information from additional evaluations of any high contaminant concentrations identified.

#### **Final language:**

4. The Permittee must update the CSM when any of the following occur:
  - a. The Permittee identifies data gaps or uncertainty concerning geology, hydrologic properties, geochemical characteristics, and/or geochemical processes that could affect mobility and transport of uranium and other metals at the Dewey-Burdock site. When this occurs, the Director may require the Permittee to collect additional data or develop alternative CSMs to accommodate and characterize the areas of uncertainty as they relate to evaluating the

potential for ISR contaminants to cross the aquifer exemption boundary. This could include, but is not limited to, characterizing geochemical processes listed under Section A.2.d.iv of this Part.

- b. Upon the identification of an expanding excursion plume as required under Part IX, Section C.5.d.
- c. Burdock Wellfields 6, 7, and 8 are developed. If the Director approves the exemption of Inyan Kara aquifers in these wellfield areas and authorizes injection into these wellfields, the preliminary CSMs developed under Part II, Section G must be updated with site-specific groundwater and solid-phase data collected from the restored wellfield prior to conducting final geochemical modeling for the Wellfield Closure Plan.

**Reason for Change:** As a result of evaluating Part IV, Part A CSM requirements, EPA made changes to Part IV, Section A.4, (formerly Section A.3) which specifies when the Permittee must update the CSM. See Change #40 to the Class III Permit above.

#### **54. Part IV, Section B:**

**Draft language:**

B. Development of a Reactive Transport Geochemical Model

The Permittee shall develop a reactive transport geochemical model to evaluate the potential for ISR contamination to cross the aquifer exemption boundary.

**Final language:**

B. Reactive Transport Geochemical Modeling

The Permittee must conduct reactive transport geochemical modeling for each wellfield to evaluate the potential for ISR contaminants to cross the aquifer exemption boundary. Constituents considered to be ISR contaminants under this Area Permit are listed in Appendix B, Table B-1. The objective of the modeling is to demonstrate that the concentration of each ISR contaminant will not exceed the permit limit (or alternate permit limit, if applicable) at the aquifer exemption boundary within the injection-interval aquifer. Modeling results will become part of the Wellfield Closure Plan for all ISR wellfields.

**Reason for Change:** As a result of reevaluating Part IV, Part B geochemical modeling requirements, EPA has made several changes to this section. The section heading was updated to be consistent with the requirement that the Permittee must develop more than one model. The updated introductory paragraph includes a reference to the ISR contaminants listed in Appendix B, Table B-1. The updated paragraph includes the objective of geochemical modeling. See Change #40 to the Class III Permit above.

#### **55. Part IV, Section B.1.c:**

**Draft language:**

- c. Evaluation of any localized, elevated concentrations above the restoration criteria remaining in the wellfield injection interval following restoration.

**Final language:**

- c. Where another wellfield is located upgradient adjacent to the wellfield, chemistry of the post-restoration groundwater within the upgradient wellfield must be included in the modeling scenarios.

**Reasons for Change:** As a result of evaluating Part IV, Part B geochemical modeling requirements, this section, which specifies the scenarios the Permittee must incorporate into the geochemical modeling, includes new requirement **c**, which states that chemistry of the post-restoration groundwater within the upgradient wellfield must be included in the modeling scenarios, where another wellfield is located upgradient adjacent to the wellfield. EPA deleted former requirement **c** that require evaluation of any localized, elevated concentrations above the restoration criteria remaining in the wellfield injection interval following restoration. After further considering the efficacy of this requirement, EPA determined that this information was not pertinent to development of the geochemical models and falls under NRC's purview rather than EPA's.

**56. Part IV, Section B.2 Introductory paragraph:**

**Draft language:**

2. The ultimate objective of the geochemical model is to simulate as accurately as possible the fate and transport of ISR contaminants as they interact with downgradient, injection-interval geochemical conditions, such that the model becomes a tool to evaluate the potential for ISR contaminants to cross the aquifer exemption boundary. Because simulations representing long-term post-restoration conditions and transport are purely predictive and will lack field-verification of results, geochemical modeling shall be performed on an iterative basis during project phases when field and laboratory measurements can be used to calibrate the model and additional data can be collected as needed to verify simulation results. The following requirements are designed to achieve this objective.

**Final language:**

**2. Predictive modeling of contaminant transport for each wellfield closure**

The Permittee must conduct predictive modeling of contaminant transport for each wellfield closure. The preliminary modeling conducted under Part II Section G as part of the Injection Authorization Data Package for wellfields 6, 7, and 8 must be updated on the basis of data collected for the full CSM developed under Part IV.A, including characterization of the restored wellfield, if the Director approves the exemption of Inyan Kara aquifers in these wellfield areas and authorizes injection into these wellfields.

**Reason for Change:** EPA received comments expressing concerns that modeling on an iterative basis for calibration during groundwater restoration and post-restoration stability monitoring phases of the project is impractical, unnecessary, and potentially cost prohibitive. The 2019 Draft Permit included requirements to successively calibrate the geochemical model to conditions during these phases in order to verify model input parameters at the wellfield scale prior to conducting long-term predictive simulations. EPA has removed the requirement to iteratively (successively) calibrate the model to the restoration and post-restoration stability monitoring phases of the project because it has determined that the unstable geochemical conditions within the wellfield during these phases may make calibration infeasible. Furthermore, modeling during these phases is not necessary for simulating the long-term transport of ISR contaminants toward the aquifer

exemption boundary after the wellfield has been restored. Long-term predictive simulations will be based on the final geochemistry of the restored wellfield.

In place of the iterative wellfield-scale calibrations, the Final Permit requires calibration to stable background groundwater flow and geochemical conditions along a flow path that extends over a larger area that includes areas upgradient, downgradient, and within the wellfield and provides a better basis for meeting the modeling objective to evaluate ISR contaminant concentrations at the aquifer exemption boundary. To allow flexibility in the event that problems are encountered with calibrating to background conditions, the Final Permit also includes a provision for other calibration approaches with Director's approval (see Change #62 to the Class III Permit below). To provide clarity concerning modeling requirements for Burdock Wellfields 6, 7, and 8, the revised requirement also includes updating the preliminary models for these wellfields based on the full CSM and restored wellfield conditions.

**57. Part IV, Sections B.2.a and b:**

**Draft language:**

- a. The Permittee shall conduct iterative modeling (batch reaction or reactive transport) for calibration and verification including representation of the following:
  - i. Interactions between restoration fluids and groundwater in the wellfield injection interval during the restoration phase; and
  - ii. Wellfield conditions during the post-restoration stability monitoring phase.
- b. The Permittee shall conduct predictive modeling of contaminant transport for site closure that includes the following:
  - i. Reactive transport of post-restoration fluids in the wellfield downgradient toward the aquifer exemption boundary;
  - ii. Reactive transport of upgradient groundwater into the restored wellfield and subsequently farther downgradient toward the aquifer exemption boundary.

**Final language:**

Predictive modeling for each wellfield must include the following:

- a. Reactive transport of post-restoration fluids in the wellfield flowing downgradient toward the aquifer exemption boundary;
- b. Reactive transport of upgradient groundwater, including from any adjacent wellfields, into the restored wellfield and subsequently farther downgradient toward the aquifer exemption boundary.

**Reason for Change:** EPA updated this requirement to remove iterative modeling for reasons stated in Change #58 to the Class III Permit above and to specify requirements for predictive modeling.

**58. Part IV, Section B.3:**

**Draft language:**

3. Model Specifications
  - a. The model shall be constructed based on the CSM described in Part IV, Section A of this permit and results of laboratory and field testing specified in Part IV, Section C.

- b. The areal extent of the model domain may vary by wellfield and simulation purpose. Reactive transport models for predictive simulations for site closure shall incorporate an area that enables simulation of groundwater flow and geochemical processes from upgradient, through the wellfield, and into downgradient areas. It shall include the upgradient areas to the northeast of wellfields as well as the monitoring-well ring and a margin beyond the aquifer exemption boundary to account for longer term transport.
- c. The vertical model extent shall represent the full injection interval. In the event that a vertical excursion out of the injection interval is indicated, the model shall also include the excursion interval and confining zones.
- d. Cell size and spacing in the model domain shall allow for adequate resolution when simulating geochemical processes at the site. Modeling may be 3-D, 2-D, or 1-D as needed to represent conditions across the site. If 2-D or 1-D modeling is used, enough simulations shall be used to represent site heterogeneity.
- e. Geochemical boundary conditions of the model shall:
  - i. Accurately represent mineral phases, gas partial pressures, and concentrations of constituents in groundwater;
  - ii. Be based on field data that meet the project's data quality objectives;
  - iii. Represent the oxidation states of the mineral assemblages; and
  - iv. Not overly constrain model results to produce unrealistic modeling predictions.
- f. Temporal discretization of model runs shall be appropriate to represent the time scale of changes in site geochemistry for the system being simulated (groundwater restoration, post-restoration stability, and reactive transport) and cover a sufficient timeframe to reestablish natural groundwater flow conditions and simulate the potential rebound of uranium and other metals.

**Final language:**

3. Model Specifications

- a. The models must be constructed based on the CSM described in Part IV, Section A of this permit and requirements specified in Part IV, Section C.
- b. The areal extent of the model domain may vary by wellfield, but must incorporate an area that enables simulation of groundwater flow and geochemical processes from upgradient, through the wellfield, and into the area downgradient from the wellfield, including a margin beyond the aquifer exemption boundary sufficient to demonstrate protection of USDWs.
- c. The vertical model extent must represent the full injection interval aquifer. In the event that a vertical excursion out of the injection interval is indicated, the model must also include the excursion interval and confining zones.
- d. Cell size and spacing in the model domain must be based on groundwater flow velocity and allow for adequate resolution when simulating geochemical processes along flow paths.
- e. Reactive transport models may be 3-D, 2-D, or 1-D as needed to represent conditions across the site. If 2-D or 1-D modeling is used, enough simulations must be used to represent site heterogeneity, including areas of high residual concentrations, within each injection interval and flow-path variations through each wellfield based on site-specific data.
- f. Geochemical boundary conditions of the model must:
  - i. Accurately represent mineral phases, gas partial pressures, and concentrations of constituents in groundwater;

- ii. Be based on site-specific field and laboratory data;
- iii. Represent the oxidation states of the mineral assemblages and saturation indices of the groundwater; and
- iv. Not overly constrain model results to produce unrealistic modeling predictions.
- g. Model runs must cover a sufficient timeframe to reestablish natural groundwater flow conditions and simulate the transport of ISR contaminants to the aquifer exemption boundary, including the potential rebound of uranium and other metals.
- h. Modeling must include ISR contaminants listed in Appendix B, Table B-1. Modeling is not required for ISR contaminants that have been shown by monitoring under Part IX, Section B.3.a to have concentrations at or below the permit limit or the groundwater background concentration at all injection interval wells within the wellfield after completing ISR operations and prior to initiating wellfield restoration.

**Reason for Changes:** These changes to the model specifications were made to better align with the revised modeling approach discussed in #55 and #57 above, clarify EPA's expectations for the models, and help ensure model uncertainty is minimized. EPA updated requirements under Part IV, Section B.3 to require the Permittee to include any areas of high residual concentrations within each restored injection interval and flow-path variations through each wellfield based on site-specific data, ensure geochemical boundary conditions accurately represent saturation indices and model runs cover a sufficient timeframe to simulate the transport of ISR contaminants to the aquifer exemption boundary. New requirements include reference to Appendix B, Table B-1 and exempt from modeling, reactive transport of any ISR contaminants that have been shown by monitoring under Part IX, Section B.3.a to have concentrations at or below the permit limit or the groundwater background concentration within the wellfield after completing ISR operations and prior to initiating wellfield restoration.

#### **59. Part IV, Section B.4:**

##### **Draft language:**

4. Equilibrium, Kinetic, and Sorption Data
  - a. The thermodynamic data used by the modeling program shall contain the most up-to-date information available on uranium and other constituents of concern at the site, such as those presented by Guillaumont et al. (2003), Dong and Brooks (2006), and Muhr-Ebert et al. (2019).
  - b. Where important reactions or kinetics are not included in the model's thermodynamic database, the databases shall be augmented with site-specific data from laboratory and field studies as described in Part IV, Section C.
  - c. The basis of the modeling program's thermodynamic database shall be noted, along with any data that are edited/updated for this modeling effort, including the source of the data added. Limitations and uncertainties associated with the thermodynamic database shall be noted, including any constituents controlled by species that are not included in the database.
  - d. The activity-coefficient model used to simulate reactions shall be chosen based on the range of ionic strengths and groundwater constituents measured in baseline groundwater, lixiviant, restoration fluid, and expected post-restoration groundwater.



**Final language:**

4. Equilibrium, Kinetic, and Sorption Data

- a. The thermodynamic data used by the modeling program must contain up-to-date information available on uranium and other constituents of concern at the site, such as, but not limited to, those presented by Guillaumont et al. (2003), Dong and Brooks (2006), Mahoney et al. (2009), and Mühr-Ebert et al. (2019).
- b. Where important reactions or kinetics (if simulated) are not included in the model's thermodynamic database, the databases must be augmented with site-specific data from laboratory and field studies as described in Part IV, Section C.
- c. The activity-coefficient model used to simulate reactions must be chosen based on the range of ionic strengths and constituents measured in background groundwater and the post-restoration groundwater within the wellfield.

**Reason for Change:** To provide more clarity and help ensure up-to-date sorption and other thermodynamic data are used, Part IV, Section B.4, which covers *Equilibrium, Kinetic, and Sorption Data* requirements, was revised to include an additional example of a reference for the model's thermodynamic database and to state that up-to-date information is not limited to the listed examples. EPA removed reference to reactions involving lixiviant (during ISR operations) and groundwater restoration fluid. As discussed in Change #58 to the Class III Permit above, information from ISR operations, groundwater restoration and post-restoration stability monitoring phases is not necessary for simulating the transport of ISR contaminants toward the aquifer exemption boundary. Consistent with the requirement under Part IV, Section B.2, this updated requirement focuses on stable groundwater geochemistry at pre-ISR conditions and the final geochemistry of the restored wellfield. EPA also moved the requirement for the Permittee to note the thermodynamic database's basis, limitations and uncertainties to Part IV, Section D.2 Wellfield Closure Plan documentation requirements, where this information will be incorporated.

**60. Part IV, Section B.5:**

**Draft language:**

5. Model calibration

To reduce model prediction uncertainty concerning the long-term fate and transport of ISR contamination at the Dewey-Burdock site, the model shall be iteratively calibrated as follows:

- a. The model shall be calibrated to hydrologic and geochemical conditions observed during the wellfield restoration phase to verify that important processes related to interactions between restoration fluids and groundwater are accurately represented.
- b. The model shall be calibrated to hydrologic and geochemical conditions observed during the post-restoration monitoring phase to verify that processes in the restored wellfield are accurately represented.
- c. The model shall be calibrated to site-specific field and laboratory data as described by Part IV, Section C.
- d. Batch-reaction and/or reactive-transport modeling may be used to achieve calibration modeling objectives.
- e. Where the Director finds that model calibration indicates an unsatisfactory match to observed site-specific hydrologic or geochemical conditions as determined by the Director,

additional data shall be collected, and/or the model shall be revised to provide a better match to the observations.

**Final language:**

5. Model calibration

To reduce model prediction uncertainty concerning the long-term fate and transport of ISR contamination, the model must be calibrated as follows:

- a. The model must be calibrated by using site-specific field and laboratory data as described by Part IV, Section C.
- b. Prior to conducting predictive simulations, the model must be calibrated to background hydrogeologic and geochemical conditions at the site to verify conditions at the field scale.
  - i. The model must have the same domain (2-D or 3-D model) or flow path (1-D model) to be subsequently used for predictive simulations.
  - ii. Model calibration must consist of adjusting model input parameters over a representative range of values based on site-specific data to match the distribution of groundwater chemistry observed from upgradient to downgradient across the area where the wellfield will be located.
- c. Other calibration approaches may be used with Director's approval.
- d. Where the Director finds model calibration indicates an unsatisfactory match to observed site-specific hydrologic or geochemical conditions, the Director may require that additional data be collected and/or the model be revised to provide a better match to the observations. This could include, but is not limited to, simulating geochemical processes listed under Part IV, Section A.2.d.iv.

**Reason for Change:** To improve the feasibility of the calibration approach and calibrate the model to hydrologic and geochemical conditions over a larger area (see Change #58 to the Class III Permit above), the requirement to iteratively (successively) calibrate the model to conditions observed during the restoration and post-restoration monitoring phases of the wellfield were replaced with a requirement to calibrate the model to background aquifer conditions along a flow path across the wellfield location or to use another approach with Director's approval.

**61. Part IV, Section B.6:**

**Draft language:**

6. Uncertainty Analysis

Uncertainty analysis shall attempt to quantify prediction uncertainty concerning the long-term fate and transport of ISR contamination at the Dewey-Burdock site. This may include forward Monte Carlo simulations, inverse modeling, or other methods but at a minimum shall include the following:

- a. Sensitivity analyses for all geochemical parameters that could have a substantial effect on simulation results, such as pH, pe, alkalinity, groundwater-flow rate, effective porosity, and the quantity or concentration of calcite, pyrite, iron, carbon-dioxide, and organic-carbon concentrations.
- b. Evaluation of prediction uncertainty by conducting multiple simulations using a range of hydrologic and geochemical values representative of observed conditions across the site to

indicate the potential range of outcomes. Predictive ranges shall include measurement and analytical uncertainties, system heterogeneity, and calibration uncertainty.

- c. For model assumptions having high uncertainty, the Director may require that alternative CSMs be generated to explore the effects on reactive transport geochemical model output.

**Final language:**

6. Uncertainty analysis must attempt to quantify prediction uncertainty concerning the long-term fate and transport of ISR contamination at the Dewey-Burdock site. This may include techniques such as forward Monte Carlo simulations, inverse modeling, or other methods but at a minimum must include the following:
  - a. Sensitivity analyses for pH, pE, alkalinity, and the quantity or concentration of calcite, pyrite, dissolved oxygen, carbon-dioxide, and organic-carbon, as well as other parameters found to have a substantial effect on simulation results. In addition, for Burdock Wellfields 6, 7, and 8 and any other wellfield found to have downgradient oxidized aquifer conditions, sensitivity analyses must be conducted for sorption parameters based on results of laboratory testing described under Part IV, Section C.3.d.
  - b. Quantitative evaluation of prediction uncertainty by conducting multiple simulations using a range of hydrologic and geochemical values representative of observed conditions across the site to indicate the potential range of outcomes.
    - i. Predictive ranges must include measurement and analytical uncertainties, system heterogeneity, and calibration uncertainty.
    - ii. Predictions shall be reported with a confidence interval of 90 percent or greater based on the statistical distribution (probability density function) of observed model input parameter values.
  - c. For model assumptions having high uncertainty, the Director may require that alternative CSMs be generated to explore the effects on reactive transport geochemical model output.

**Reason for Change:** These changes were made both in response to concerns about the draft's vagueness of requirements as well as about the model's accuracy. In consideration of these concerns, EPA updated the uncertainty analysis requirements to better define the predictive certainty of modeling results. EPA added dissolved oxygen to the list of parameters designated for sensitivity analyses. EPA also added sorption parameters because these parameters could have a substantial effect on simulation results for Burdock Wellfields 6, 7, and 8, which have partially-oxidized downgradient aquifer conditions.

EPA revised Part IV, Section B. to specify that evaluation of prediction uncertainty must be quantitative and that predictions must be reported with a confidence interval of 90 percent or greater based on the statistical distribution (probability density function) of observed model input parameter values. Specification of confidence intervals for model output helps clarify model uncertainty and EPA's expectations for presenting model results.

**62. Part IV, Section C:**

**Draft language:**

- C. Monitoring, Laboratory Testing, and Field Investigations to Calibrate the Geochemical Model with Site-Specific Data

The Permittee shall calibrate the geochemical model with site-specific data from monitoring, laboratory testing, and/or other field investigations to provide the most reliable model possible for evaluating the potential for ISR contaminants to cross the aquifer exemption boundary.

**Final language:**

C. Groundwater Sampling, Core Collection, Laboratory Testing, and Field Investigations to Support the Conceptual Site Model and Geochemical Modeling

The Permittee must develop the CSM under Part IV, Section A and conduct geochemical modeling specified under Part IV, Section B based on site-specific data from groundwater sampling, core collection, laboratory testing, and/or other field investigations to minimize uncertainty concerning the potential for ISR contaminants to cross the aquifer exemption boundary. Data collected under this Part must be used in the development of the CSM described under Part IV.A and will become part of the Wellfield Closure Plan for all ISR wellfields.

**Reason for Change:** The Section title has been updated to reflect that the section now contains information that supports the CSM and geochemical modeling, rather than just model calibration. The introductory paragraph has been updated to explain that the Permittee must develop the CSM and conduct geochemical modeling based on site-specific data to minimize uncertainty concerning the potential for ISR contaminants to cross the aquifer exemption boundary. The term “monitoring” was replaced with “groundwater sampling” to reflect that the requirements relate to site characterization rather than ongoing monitoring. EPA included a statement to clarify for Powertech that data collected under this Part must be used in the development of the CSM described under Part IV.A and will become part of the Wellfield Closure Plan for all ISR wellfields, but is not required to be included in the Injection Authorization Data Package Reports (Part II, Section H) for the Permittee to obtain authorization to inject into the wellfield. EPA also added a new section at C.2 to include specifications for core collection.

**63. Part IV, Section C.1:**

**Draft language:**

1. Monitoring
  - a. Hydraulic head levels shall be measured and water-quality monitoring for excursion parameters within the wellfield injection interval shall be conducted twice monthly during active ISR activities and every 60 days during groundwater restoration and stability monitoring to provide calibration data for the model and update the CSM.
  - b. Once groundwater restoration begins, the Permittee shall conduct water quality monitoring for parameters listed in Table 8 at a frequency sufficient to determine the success of aquifer restoration, optimize the efficiency of aquifer restoration, and determine if any areas of the wellfield require additional action, but no less frequently than once per quarter. The Permittee shall include information on evaluation of any flare zones or areas with high contaminant concentrations.

- c. Once restoration stability monitoring begins, the Permittee shall conduct quarterly water quality monitoring for parameters listed in Table 8, including additional evaluations of any areas with high contaminant concentrations.
- d. The Permittee shall collect the water quality monitoring samples described under b. and c. above from the injection interval wells used to determine Commission Approved Background concentrations as discussed under condition 11.3 of the NRC license.
- e. All monitoring shall meet data-quality objectives.

**Final language:**

1. Groundwater Sampling
  - a. Groundwater samples must be collected from wellfield perimeter monitoring wells, the wellfield injection interval wells used to determine Commission-approved background, and the monitoring wells completed in aquifers above and below (where applicable) the injection interval in accordance with Part II, Section E.2.b.i.
  - b. Once post-restoration stability monitoring begins, the Permittee must conduct quarterly water quality monitoring for parameters listed in Table 8 in accordance with Part IX, Section B.4, including additional evaluations of any areas with high contaminant concentrations. Final constituent concentrations at the end of the stability-monitoring phase may be used to represent the groundwater chemistry of the restored wellfield.
  - c. Upon the identification and verification of an expanding excursion plume as described under Part IX, Sections C.4.e and C.4.f, the Permittee shall collect a groundwater sample from the impacted well(s) and analyze the sample(s) for the water quality parameters in Table 8 in accordance with Part IX, Section C.4.g.

**Reason for Change:** To be consistent with revisions to Part IV, Sections A and B, EPA updated requirements **a**, **b**, **c** and **d** under this section to remove requirements for monitoring during the active ISR and groundwater restoration phases. As discussed under Changes #40 and #58 of the Class III Permit above, EPA has re-evaluated requirements and determined that model calibration to geochemically unstable wellfield conditions, and therefore monitoring during these phases, is not necessary to meet the objective of modeling the transport of ISR contaminants toward the aquifer exemption boundary after the wellfield has been restored. Long-term predictive simulations will be based on the final geochemistry of the restored wellfield, which will be determined using the results of post-restoration stability monitoring. Although requirements for monitoring during active ISR and groundwater restoration for the purposes of model input have been removed from Part IV, operational groundwater monitoring, including during the active ISR and groundwater restoration phases, is still required under Part IX of the permit.

Also, Part IV now references the applicable groundwater sampling requirements under Part II, Section E.2.b.i; the new post-restoration stability monitoring requirements included under Part IX, Section B.4; and the sampling of verified expanding excursion plumes in accordance with Part IX, Section C.4.g. EPA has removed requirement **e** concerning meeting data-quality objectives because DQOs applicable to each type of monitoring parameter under this requirement are captured under Part IX, Section A and Section B.1. EPA changed the section heading from “Monitoring” to

“Groundwater Sampling” because that is a more accurate description of the requirements under this section.

**64. Part IV, Section C.2:**

**Draft language:**

(. . .)

f. Core data shall be collected for conducting batch sorption and column tests for calibration of the geochemical model.

Core samples supporting laboratory testing shall:

- i. Include a sufficient number of samples to adequately characterize both horizontal and vertical heterogeneity with respect to hydrogeology and geochemical conditions within the injection interval;
- ii. Be analyzed by using approved methods with few fractured or broken samples;
- iii. Be recovered and preserved in a manner to prevent further oxidation so as to be representative of in-situ geochemical conditions for use in columns tests; and
- iv. Be collected at representative locations within each wellfield as well as upgradient and downgradient of wellfields.

**Final language:**

2. Core Collection

Core samples shall be collected at representative locations within each wellfield and from areas upgradient and downgradient from each wellfield to characterize aquifer solids for the CSM based on site-specific data. Core collected to support the CSM shall meet the following requirements:

- a. Core shall include a sufficient number of samples to adequately characterize both horizontal and vertical heterogeneity with respect to hydrogeology and geochemical conditions within the injection interval but at a minimum shall include the following:
  - i. Wellfield Core
    - A) To characterize background aquifer solid phases, core shall be collected from one corehole location per 40 acres of wellfield area or 2 corehole locations, whichever is greater, prior to initiating ISR operations. Core collected for the purpose of meeting this minimum requirement shall be collected at or near wells used to determine background groundwater quality.
    - B) To characterize aquifer solid phases within the restored wellfield, core shall be collected from one corehole location per 40 acres of wellfield area or 2 corehole locations, whichever is greater, after completing the wellfield restoration process. Core collected for the purpose of meeting this minimum requirement shall be collected near locations where background core was collected according to Section C.2.a.i.A) above.
  - ii. Upgradient Core
    - Core shall be collected from the area upgradient of the wellfield based on one corehole location per 2,400 linear feet of wellfield perimeter representing the upgradient side of

the wellfield, or 2 corehole locations, whichever is greater. Core collected for the purpose of meeting this minimum requirement shall be collected at or near wells used to determine background groundwater quality and shall be from locations distributed across the upgradient area.

iii. Downgradient Core

Core shall be collected from the area downgradient of the wellfield based on one corehole location per 1,200 linear feet of wellfield perimeter representing the downgradient side of the wellfield, or 4 corehole locations, whichever is greater. Core collected for the purpose of meeting this minimum requirement shall be collected at or near wells used to determine background groundwater quality and shall be from locations distributed across the downgradient area.

iv. Core Representing Vertical Heterogeneity

A minimum of 3 cores shall be collected from the injection interval at each corehole location in the wellfield and in areas upgradient and downgradient from each wellfield. Core intervals should be selected to represent lithologic variability within the injection interval. Lithologic logs, geophysical logs, or other methods may be used to identify lithologic variability and target intervals for coring.

- b. Core must have sufficient length to accurately identify mineral assemblages and solid phases in quantities representative of the injection interval.
- c. Core must be recovered and preserved in a manner to prevent further oxidation so as to be representative of in-situ geochemical conditions for use in laboratory testing.
- d. Core collected as part of site-wide characterization activities prior to wellfield development may be used to represent solid phases for individual wellfields provided it meets location, length, and preservation requirements described in Sections C.2.a. through C.2.c. of this Part.
- e. Core may be collected as part of well-drilling operations or collected from independent coreholes as needed to characterize the site.
- f. All independent coreholes must, upon completion of coring operations at each corehole, be plugged with bentonite or cement grout in a manner which prevents the movement of fluids into or between USDWs in accordance with 40 CFR § 146.10 and applicable portions of the approved plugging and abandonment plan described under Part XI, Section C.

**Reason for Change:** In response to concerns about the vagueness of modeling requirements, EPA included these changes which enumerate additional and more specific requirements for core collection and analysis, expanding beyond the briefer requirements in the draft permit. Former Section C.2 core collection requirements have been incorporated into this new section. This section specifies the number, size, and locations of core to collect for evaluating solid phases and conducting laboratory testing in order to clarify EPA's expectations for core collection and help ensure sufficient mineralogical information is collected to support the geochemical model.

**65. Part IV, Section C.3 (formerly Section C.2):**

**Draft language:**

2. Laboratory Testing

Laboratory testing is needed to constrain geochemical parameters and processes controlling uranium mobility and retention and to determine sorption parameters and possible mineral dissolution or precipitation reactions.

- a. Laboratory testing shall be conducted with site-specific solids from the Dewey-Burdock site and fluids representative of site geochemical conditions, including potential conditions during baseline, groundwater restoration and restoration stability monitoring phases of the project.
- b. Batch-sorption tests may be used to provide data for model calibration to equilibrium conditions. However, column studies shall be used to provide more realistic data that consider kinetic rates and rate-limited sorption for reactive-transport simulations concerning the potential for ISR contamination to cross the aquifer exemption boundary.
- c. Laboratory testing shall include analysis of interactions between:
  - i. Restoration fluids and core from the unrestored wellfield;
  - ii. Restored groundwater and core downgradient from the wellfield;
  - iii. Baseline upgradient groundwater and core from the restored wellfield;
  - iv. Baseline upgradient groundwater and core downgradient from the wellfield;
  - v. Downgradient core and the upgradient groundwater after it has passed through and reacted with the restored wellfield. This can be accomplished by using leachate resulting from interactions between baseline upgradient groundwater and restored-wellfield core in a subsequent column with core from downgradient of the wellfield.
- d. Laboratory tests shall be conducted using a range of values to bracket observed conditions at each wellfield for geochemical parameters that could have a substantial effect on simulation results, such as dissolved oxygen, pH, alkalinity, calcite, pyrite, iron, carbon-dioxide, and organic-carbon concentrations.
- e. Flow in column tests shall be temporarily halted to evaluate concentration rebound and evaluate whether the column is in equilibrium with the injection fluid.

**Final language:**

3. Laboratory testing is needed to constrain geochemical parameters and processes controlling uranium mobility and attenuation and to determine sorption parameters and possible mineral dissolution or precipitation reactions.
  - a. Laboratory testing must be conducted with site-specific solids from the Dewey-Burdock site and fluids representative of geochemical conditions for the background aquifer and the restored wellfield.
  - b. Core collected under Part IV, Section C.2 must be quantitatively evaluated to determine mineral assemblages and solid phases present that may affect the transport of ISR contaminants toward the aquifer exemption boundary. At a minimum, core must be analyzed to determine quantities of calcite, clay minerals, hematite, iron oxyhydroxides, pyrite/marcasite, and organic carbon.
  - c. Analytical methods may include:



- i. Mineral and texture evaluation by thin section, transmitted light microscopy and scanning electron microscopy (SEM), and X-ray diffraction;
  - ii. Determination of chemical composition by scanning electron microscope, X-ray spectroscopy, and solids analyses for sulfur and organic carbon; and/or
  - iii. Other methods as approved by the Director.
- d. For wellfields 6, 7, and 8 and any other wellfield determined to have oxidizing downgradient groundwater conditions, geochemical reduction likely will not be the primary process controlling attenuation of ISR contaminants. Therefore, laboratory testing to determine sorption parameters for uranium and metals listed in Appendix B, Table B-1 is required to provide site-specific data for geochemical modeling.
- i. Batch-sorption tests or column studies may be used as needed to provide data for this purpose.
  - ii. Laboratory testing must be conducted using standard methods to be determined by the Permittee and approved by the Director.
  - iii. Laboratory testing must include analysis of interactions between:
    - A) Restored groundwater and core downgradient from the wellfield;
    - B) Background upgradient groundwater and core from the restored wellfield;
    - C) Downgradient core and the upgradient groundwater after it has passed through and reacted with the restored wellfield. This can be accomplished by using leachate resulting from interactions between background upgradient groundwater and restored wellfield core in a subsequent batch or column test with core from downgradient of the wellfield.
  - iv. Water used for testing purposes must represent the geochemistry of restored wellfield groundwater, background upgradient groundwater, and upgradient groundwater after it has passed through and reacted with the restored wellfield, as applicable to assess interactions described in Part IV, Section C.3.d.iii.
  - v. A sufficient number of tests must be conducted to represent the range of solid-phase compositions observed within and downgradient from the wellfield, particularly with respect to iron oxyhydroxides, clay minerals, and organic carbon.
  - vi. Laboratory tests must be conducted using a range of concentrations for uranium and metals listed in Table B-1 that bracket potential groundwater concentrations to determine how sorption varies with concentration.
  - vii. Batch tests must allow sufficient time for effective equilibrium between water and solid phases to occur. Flow in any column tests must be temporarily halted to evaluate concentration rebound and evaluate whether the column is in equilibrium with the injection fluid.
  - viii. Laboratory testing for sorption is not required for ISR contaminants shown by monitoring under Part IX, Section B.3.a to have concentrations at or below the permit limit or the groundwater background concentration at all injection interval wells within the wellfield after completing ISR operations and prior to initiating wellfield restoration.

**Reason for Change:** After reevaluation of Part IV, Section C Laboratory Testing requirements per Change #40 to the Class III Permit above, EPA revised and reorganized the requirements under Part IV, Section C.3 (formerly Section C.2). EPA removed Part IV, Section C.3.a (formerly Section C.2.a) requirements for laboratory testing of site-specific solids and fluids representative of the

groundwater restoration and restoration stability monitoring phases of the project because modeling of these phases is no longer required, as discussed under Change #40 to the Class III Permit above. Similarly, Section C.2.c (moved to Section C.3.d.iii) was revised to remove the requirement to include analysis of interactions between restoration fluids and core from the unrestored wellfield and baseline upgradient groundwater and core downgradient from the wellfield. EPA has determined that these analyses are not needed for the objective of evaluating transport of ISR contaminants toward the aquifer exemption boundary after the wellfield has been restored.

EPA added new provisions: Section C.3.b specifies minimum requirements for quantitative mineral evaluation of cores in order to improve reliability of geochemical model results. Section C.3.d.ii includes a new requirement that laboratory testing must be conducted using standard methods to be determined by the Permittee and approved by the Director to ensure that testing produces reliable results. Sections C.3.d.iv through viii were added or revised to clarify testing requirements. EPA revised C.3.c.iii (formerly C.2.g.i) to replace speciation of uranium, iron, and manganese by sequential extractions with other methods as approved by the Director to allow greater flexibility of evaluation methods.

#### **66. Part IV, Section D.1, *Wellfield Closure Plan*:**

##### **Draft language:**

1. Timing of the Wellfield Closure Plan.
  - a. When groundwater restoration begins in a wellfield, the Permittee shall use the results from the first set of water level and water quality samples collected from the injection interval monitoring wells during the restoration phase to update the CSM and use that data to calibrate the geochemical model for the wellfield.
  - b. The Permittee shall continue to update the CSM and calibrate the geochemical model during groundwater restoration, including information on any flare zones or areas with high contaminant concentrations.
  - c. Once restoration stability monitoring begins, the Permittee shall use the geochemical model to evaluate the geochemical stability of the restored ISR contaminant concentrations for comparison to observed concentrations during the restoration stability monitoring phase.
  - d. After the restoration stability phase is completed and the geochemical model has been calibrated with the final set of monitoring data, the Permittee shall use the geochemical model to evaluate the long-term geochemical stability of the restored concentrations of ISR contaminants according to Section B of this Part.
  - e. After the restoration stability phase is completed and the geochemical model has been calibrated with the final set of monitoring data, the Permittee shall conduct reactive transport modeling to evaluate the potential for ISR contaminants to cross the aquifer exemption boundary. This shall include reactive transport of post-restoration fluids in the wellfield downgradient toward the aquifer exemption boundary and reactive transport of upgradient groundwater into the restored wellfield and subsequently farther downgradient toward the aquifer exemption boundary.
  - f. Once a through e above have been completed, the Permittee shall submit the Wellfield Closure Plan to the Director for review and approval prior to wellfield closure.

- g. If the Permittee identifies the need to restore wellfield groundwater to an ACL rather than to Commission-approved background or an MCL, the Permittee shall notify EPA, and the geochemical model shall be updated to evaluate the potential for the ISR contaminants with ACLs to cross the aquifer exemption boundary. The Permittee shall amend the Wellfield Closure Plan with the ACL analysis and submit it to the Director for review and approval at approximately the same time the License Amendment application is submitted to the NRC for approval of the ACL.
- h. The Permittee shall not remove wellfield infrastructure necessary for groundwater restoration until the Director has approved the Wellfield Closure Plan and has determined no additional aquifer cleanup and monitoring is necessary and feasible to insure adequate protection of USDWs per 40 CFR § 146.10(a)(4).

**Final language:**

1. Process for Wellfield Closure.
  - a. After the post-restoration stability phase is completed and the geochemical model has been calibrated, the Permittee must conduct reactive transport modeling to evaluate the long-term geochemical stability of the restored wellfield and the potential for ISR contaminants to cross the aquifer exemption boundary according to Section B of this Part. This must include reactive transport of post-restoration fluids in the wellfield downgradient toward the aquifer exemption boundary and reactive transport of upgradient groundwater into the restored wellfield and subsequently farther downgradient toward the aquifer exemption boundary.
  - b. Once modeling has been completed, the Permittee must submit the Wellfield Closure Plan to the Director for review and approval prior to wellfield closure.
  - c. The Permittee must not remove wellfield infrastructure necessary for aquifer remediation until the Director has approved the Wellfield Closure Plan and has determined no additional aquifer cleanup and monitoring is necessary and feasible to ensure adequate protection of USDWs per 40 CFR § 146.10(a)(4).

**Reason for Change:** EPA updated Section D. to provide greater clarity about the process for wellfield closure. Requirements **a**, **b** and **c** have been deleted because EPA determined that it is not necessary to develop geochemical models for these scenarios as discussed in Changes #40 and #58 to the Class III Permit above. In **c** (formerly **h**), EPA replaced “groundwater restoration” with “aquifer remediation” to distinguish the process of additional remediation required for the wellfield closure plan from the groundwater restoration process regulated by NRC.

**67. Part IV, Section D.2.h through j (formerly h and i), *Documentation for the Wellfield Closure Plan:***

**Draft language:**

- h. Model results, including an assessment of the potential for ISR contamination to cross the aquifer exemption boundary.
- i. Uncertainty of model results, including sensitivity analyses and evaluation of predictions over a range of potential site conditions.

**Final language:**

- h. Results of reactive transport simulations, including an assessment of the potential for ISR contamination to cross the aquifer exemption boundary. Model results must demonstrate that the concentration of each ISR contaminant listed in Appendix B, Table B-1 will at no time exceed the permit limit (or alternate permit limit, if applicable) at the aquifer exemption boundary within the injection interval aquifer.
- i. Description of model calibration, including results of monitoring, laboratory and field testing, and modeling performed to match observed hydrologic and geochemical conditions.
- j. Uncertainty of model results, including sensitivity analyses and evaluation of predictions over a range of potential site conditions. Predictions must be reported with a confidence interval of 90 percent or greater based on the statistical distribution of observed model input parameter values.

**Reason for Change:** EPA updated this section to include additional topics the Permittee must discuss in the Wellfield Closure Plan, which are consistent with updates discussed previously in Part IV, Section B. These requirements were added to ensure that the necessary information is included in the Wellfield Closure Plan to evaluate the potential for ISR contaminants to cross the aquifer exemption boundary.

**68. Part V, Section B.3:**

**Draft language:**

- 3. After initial well construction is complete, any subsequent changes in well construction will require a major modification of this Area Permit according to 40 CFR § 144.39 and § 124.5.

**Final language:**

- 3. After initial well construction is complete, any subsequent changes in well construction must be done by modification in accordance with 40 CFR § 144.39 and § 144.41.

**Reason for Change:** EPA received comments from Powertech indicating some confusion about permit modifications related to well construction. EPA removed the reference to a major permit modification in Part V, Section B.3 related to changes in well construction. In order to clear up the confusion, EPA cites directly to the UIC regulations to affirm that modifications of the permit will be done in accordance with the UIC regulations.

**69. Part V, Section G.7:**

**Draft language:**

- 7. The Permittee shall indicate the MAIP determined for the well in the construction report.

**Final language:**

- 7. The Permittee must indicate the MAIP determined for the **injection** well in the construction report **in accordance with Section F.7 of this Part.**

**Reason for Change:** EPA added “injection” and “in accordance with Section F.7 of this Part” to this requirement to improve clarity and consistency in response to a comment from Powertech (#89 in Table 1 of Powertech’s 2019 Class III Comments).

#### 70. Part V, Section K.2.d:

**Draft Language:**

- d. Alarms shall be installed to provide immediate warning to operators should pressures or flows fluctuate outside of normal operating ranges to enable a timely response and implementation of appropriate **corrective** action.

**Final Language:**

- d. Alarms must be installed to provide immediate warning to operators should pressures or flows fluctuate outside of normal operating ranges to enable a timely response and implementation of appropriate action.

**Reason for Change:** EPA updated all uses of the term “corrective action” in the Class III Area Permit that are not related to actions and requirements under Part III of the final Class III Area Permit. A commenter misconstrued the meaning of the term in the context of UIC regulations. As stated in the last paragraph of Response #56, corrective action generally refers to actions that a permittee must take to mitigate any *existing* conduits of fluid movement within the area of review, such as old wells or boreholes, prior to beginning injection. As a result of this comment, EPA decided to ensure consistency in the usage of “corrective action” throughout the Class III Area Permit and made this change accordingly.

The term “appropriate correction action” in the requirement under Part V, Section K.2.d. has been changed to “appropriate action” in reference to responding to alarms that provide immediate warning to operators should pressures or flows fluctuate outside of normal operating ranges to enable a timely response and appropriate action.

#### 71. Part VI, Section A.3:

**Draft language:**

3. Prior to beginning any addition or physical alteration to an injection well’s construction or injection formation, the Permittee must give advance notice to the Director. Any modification to well construction that is different from the approved well construction plan **is allowed only as a major modification of this Area Permit according to 40 CFR § 144.39 and § 124.5.**

**Final language:**

3. Prior to beginning any addition or physical alteration to an injection well’s construction or injection formation, the Permittee must give advance notice to the Director. Any modification to well construction that is different from the approved well construction plan **must be done by modification in accordance with 40 CFR § 144.39 and § 144.41.**

**Reason for Change:** EPA received comments from Powertech indicating some confusion about permit modifications related to well construction. EPA removed the reference to a major permit modification. In order to clear up the confusion, EPA cites directly to the UIC regulations to affirm that modifications of the permit will be done in accordance with the UIC regulations.

## 72. Part VI, Section A:

### Draft language:

6. If an acidizing operation is conducted on well perforations, then the Permittee shall demonstrate the integrity of cement above the well screen or open hole has not been compromised by exposure to the acid. Documentation of this demonstration shall be included in the next Quarterly Monitoring Report.

### Final language: none

**Reason for Change:** In response to a comment from Powertech, EPA has removed former requirement 6 from this section as discussed in the Response #86 of this document. Even if well screens need to be acidized, given the wells' short life span, they will not be subjected to acidizing jobs frequently enough to compromise the cement. Therefore, this would not cause a breach that would allow movement of fluid through the confining zone.

## 73. Part VII, Section C.4.d:

### Draft language:

d. Apply an induced pressure on the water column within the well casing using water or **air**.

### Final language:

d. Apply an induced pressure on the water column within the well casing using water or **compressed gas**.

**Reason for Change:** EPA made this change as discussed in Response #40 EPA determined that the type of compressed gas used to pressurize the well casing will not affect the mechanical integrity test results and therefore, not affect protection to USDWs.

## 74. Part VII, Section F.1:

### Draft language:

1. If mechanical integrity cannot be demonstrated for any injection, production, or monitoring well after workovers and **corrective** actions have been performed, the Permittee shall plug and abandon those wells according to the requirements under Part XI.

### Final language:

1. If mechanical integrity cannot be demonstrated for any injection, production, or monitoring well after workovers and **remedial** actions have been performed, the Permittee must plug and abandon those wells according to the requirements under Part XI.

**Reason for Change:** EPA changed the term "corrective actions" to "remedial actions." The requirement refers to actions taken to repair an injection well to restore mechanical integrity. As described above, the term "corrective action" has specific meaning in UIC regulations and the term "remedial action" is used in the UIC program reporting form 7520-3 to describe actions taken to repair an injection well to restore mechanical integrity. EPA wanted to be clear about the term "corrective action" given the confusion expressed by commenters in Comment #56 in the *Response to Comments* section of this document.

**75. Part VIII, Section B:**

**Draft language:**

- B. The migration of ISR contaminants across the aquifer exemption boundary into USDWs is prohibited.

**Final language:**

- B. The migration of ISR contaminants across the aquifer exemption boundary into USDWs is prohibited.

The constituents considered to be ISR contaminants under this Area Permit are listed in Appendix B, Table B-1. The permit limit for each constituent is either the permit limit listed in Appendix B, Table B-1 or the or the aquifer background concentration as determined according to Part II, Section E.2.b.iv, whichever value is higher.

**Reason for change:** EPA updated this section to refer to Appendix B, Table B-1 permit limits or background concentrations, consistent with the change discussed under Change #12 above.

**76. Part VIII, Section F,4,b,i:**

**Draft language:**

- b. This condition shall be verified by:
  - i. monitoring water levels in the injection interval perimeter monitoring wells that are **consistently** below the baseline water levels established under Section C.2 of this Part;

**Final language:**

- b. This condition must be verified by:
  - i. monitoring water levels in the injection interval perimeter monitoring wells that are below the baseline water levels established under Section C.2 of this Part **the majority of the time**;

**Reason for Change:** This change is discussed in Response #49 of this document. It would not be possible for the Permittee to assure that the groundwater levels in wellfield perimeter monitoring wells would be consistently below the baseline groundwater levels at all times.

**77. Table 14G, Quarterly:**

**Draft language:**

<b>G. QUARTERLY</b>	
ANALYZE	(...) Samples from domestic wells and operational monitoring wells listed in Table 16 for baseline parameters (Table 8)
REPORT	Annual Operational Groundwater Monitoring sample results from domestic wells, when applicable. (. . .) Any updates to the Conceptual Site Model required under Part IV, Section A.3.

**Final language:**

G. QUARTERLY	
ANALYZE	(...) Samples from operational monitoring of domestic wells for excursion parameters, except for the annual sampling event that coincides with the NRC License requirement.
REPORT	Quarterly Operational Groundwater Monitoring sample results from domestic wells. Results from Post-operational groundwater samples per Part IX, Section B.3 as applicable. Results from Post-restoration stability monitoring samples per Part IX, Section B.4 as applicable.

**Reason for Change:** EPA made these changes to the operational monitoring requirements for domestic wells for the reasons discussed in the Response #87 in the *Response to Comments* section of this document.

**78. Table 14H, 24-Hour Reporting:**

**Draft language:**

If any seismic event measuring **4.0** magnitude (MMI scale) or greater is reported within two miles of the permit boundary per Part IX, Section D.

**Final language:**

If any seismic event measuring **4.5** magnitude (MMI scale) or greater is reported within two miles of the permit boundary per Part IX, Section D.

**Reason for Change:** EPA made change this to Table 14H for reasons discussed in the Response #168 in the *Response to Comments* section of this document.

**79. Table 14I, Annually:**

**Draft Language: none**

**Final Language:**

I. ANNUALLY	
ANALYZE	Operational Monitoring samples from domestic wells for NRC list of analytes.
REPORT	Analytical results for Operational Monitoring samples from domestic wells. AOR update per Part V, Section H for each year construction is delayed at the Project Site

**Reason for Change:** EPA added a sub-table to Table 14 to be consistent with monitoring and reporting that is required on an annual basis. The requirements include the annual operational monitoring of domestic wells for the NRC list of analytes, as discussed under Change #79 of the Class III Permit above and the annual update of AOR wells required under Part V, Section H during the years before wellfield construction begins at the Project Site. Requirements under Part V, Section H



were included in the second draft Class III Area Permit, but they were not incorporated into Table 14 as an oversight.

**80. Part IX, Section B.2:**

**Draft language:**

2. Determining Baseline Water Quality

The Permittee shall determine baseline water quality Commission-approved background groundwater quality data for the ore zone, overlying aquifers, underlying aquifers, alluvial aquifers (where present), and the perimeter monitoring areas according to the requirements under Section 11.3 Establishment of Commission-Approved Background Water Quality in the NRC Source Material License.

**Final language:** none

**Reason for Change:** EPA has deleted this requirement for determining baseline water quality for reasons discussed in Change #7 to the Class III Permit above. EPA has determined that deleting this requirement does not decrease protection of USDWs because this requirement still exists at Part II, Section E.2.b of the Class III Area Permit.

**81. Part IX, B.2.a.iii:**

**Draft language:**

3. Operational Groundwater Monitoring

a. Domestic Wells

- iii. Samples shall be collected quarterly and analyzed for the baseline water quality parameters listed in Table 8.

**Final language:**

1. Operational Groundwater Monitoring

a. Domestic Wells

- iii. Samples must be collected quarterly and analyzed for the three excursion parameters, except for the sample collected at the time of the annual monitoring sample required under the NRC license. The annual sample must be analyzed for the analytes in Table 5.7-2: List of Baseline Parameters in the NRC Safety Evaluation Report.

**Reason for Change:** EPA made these changes to the operational monitoring requirements for domestic wells for the reasons discussed in the Response #87 in the *Response to Comments* section of this document.

**82. Part IX, Section B:**

**Draft Language:**

None

**Final Language:**

3. Post-Operational Groundwater Monitoring
  - a. After completing ISR operations and prior to initiating the wellfield restoration process, groundwater samples may be collected at the Permittee's discretion from the wellfield injection interval wells used to determine Commission-approved background concentrations as discussed under condition 11.3 of the NRC license and analyzed for parameters listed in Table 8, including radium-228.
  - b. Any ISR contaminant listed in Appendix B, Table B-1 having a concentration at or below the permit limit or the groundwater background concentration at all injection interval wells within the wellfield may be excluded from geochemical modeling described under Part IV, Section B of this Permit.
  - c. If radium-228 is not detected in a well, then this parameter may be omitted from the analyte list for analysis of subsequent samples from that well.
4. Post-Restoration Stability Monitoring
  - a. Groundwater samples must be collected quarterly from injection interval wells used to determine Commission Approved Background concentrations as discussed under condition 11.3 of the NRC license and analyzed for parameters listed in Table 8.
  - b. Additional samples must be collected as necessary for evaluation of any areas with high contaminant concentrations.

**Reason for Change:** In response to a comment from Powertech, EPA added the new Part IX, Section B.3.a and b monitoring between the end of ISR operations and the beginning of groundwater restoration. These changes are consistent with Part IV, Section B.3.h, another new requirement added in response to Powertech discussed in Change #60 to the Class III Permit above. As discussed in Response #73, EPA does not agree with limiting the constituent list as suggested by Powertech. However, EPA has determined that the geochemical model does not need to include the fate and transport of any ISR contaminants that did not increase in concentration above permit limits during ISR activities. Response #73 explains that if an ISR contaminant does not increase in concentration during the injection of chemically reactive lixiviant, it will not increase in concentration during groundwater restoration or post-restoration stability monitoring. Therefore, it would meet permit limits at the aquifer exemption boundary.

EPA added new requirements under Part IX, Section B.4 for Post-Restoration Stability Monitoring to be consistent with updates to Part IV, Section A.3.c and Part IV, Section C.1.b which require the Permittee to include this data in the Conceptual Site Model.

**83. Part IX, Section C.4.a:**

**Draft Language:** None

**Final Language:**

**4. During a Confirmed Excursion Event**

- a. **Notify the Director within 24 hours:** If an excursion has been confirmed under Section C.3 of this

Part, the Permittee must notify the Director within 24 hours of receiving the confirmation sampling results.

**Reason for Change:** The twenty-four hour reporting requirement in UIC regulation § 144.51(l)(6) applies only to non-compliances with UIC permit requirements or regulations. Excursion events are not a non-compliance with Class III Area Permit conditions or a violation of UIC regulations unless ISR contaminants cross the aquifer exemption boundary. Therefore, EPA moved the requirement for reporting a confirmed excursion to the Director within twenty-four hours to Part IX, Section C.4.a.

**84. Part IX, Section C.4.e (formerly d):**

**Draft Language:**

**d. Criteria for Expanding Excursion Plume:**

- i. If groundwater sample analyses from either an adjacent unimpacted wellfield perimeter monitoring well or a non-injection interval begin to show concentrations of any two excursion indicator parameters that exceed their respective UCL, as established under the NRC License, or any one excursion indicator parameter exceeds its UCL by 20 percent, the excursion criterion is exceeded and the excursion is now considered to be an expanding excursion plume.
- ii. If groundwater sample analyses in a non-injection interval monitoring well show increasing concentrations in excursion parameters during four consecutive sampling periods or an existing non-injection interval excursion expands to an adjacent unimpacted monitoring well.

**Final Language:**

**e. Criteria for Expanding Excursion Plume:**

- i. If excursion monitoring shows that an adjacent unimpacted wellfield perimeter monitoring well or an adjacent unimpacted non-injection interval monitoring well becomes impacted by an existing excursion, the excursion is now considered to be an expanding excursion plume.
- ii. Even if no adjacent monitoring wells are impacted by an existing excursion as described in Section 4.e.i, if excursion monitoring shows increasing concentrations in excursion parameters over four consecutive sampling periods, the excursion is now considered to be an expanding excursion plume.

**Reason for Change:** Upon reviewing a comment from Powertech about this requirement (#98 in Table 1 of Powertech's 2019 comments on the second draft Class III Area Permit), EPA realized the intent of the requirement was unclear. EPA updated each criterion for clarity. The new language differentiates between an existing excursion expanding to adjacent, previously unimpacted monitoring wells in requirement 4.e.i and an increase in concentrations of excursion parameters over four consecutive weekly sampling events in an impacted monitoring wells 4.e.ii, both of which indicate expanding excursion plumes under the final Class III Area Permit.

**85. Part IX, Section C.4.g.i, ii and iii (formerly C.3.f.i, ii and iii):**

**Draft Language:**

**f. Additional Requirements for Expanding Excursion Plumes**

- i. For excursions detected in non-injection interval monitoring wells that 1) show excursion parameter concentrations increasing for four consecutive weeks or 2) if an excursion plume in a non-injection interval expands to include an adjacent non-injection interval monitoring well, in addition to the monitoring required under 3a and 3b above, the Permittee shall collect a groundwater sample from the impacted well(s) and analyze the sample(s) for the baseline parameters in Table 8.
- ii. For expanding excursions detected in the injection interval that 1) show excursion parameter concentrations increasing for four consecutive weeks or 2) the expanding excursion plume expands further to impact adjacent wellfield perimeter monitoring wells, the Permittee shall collect a groundwater sample from the impacted well(s) and analyze the sample(s) for the baseline parameters in Table 8.
- iii. The Permittee must continue to analyze groundwater samples from impacted monitoring wells described under i above for the water quality parameters in Table 8 on a monthly basis until excursion parameter concentrations show decreasing concentrations for three consecutive weekly sampling periods required under 4.a above. Water quality parameter analytical results must be used to calibrate the geochemical model required under 5 below.
- iii. After the excursion is corrected, the Permittee must collect a final sample from each impacted non-injection interval monitoring well and analyze it for the water quality parameters in Table 8 to determine if additional aquifer remediation is required in the excursion-impacted area of the non-injection interval.

**Final Language:**

**g. Additional Requirements for Expanding Excursion Plumes**

- i. For monitoring wells impacted by expanding excursion plumes, in addition to the monitoring required under Sections C.4.b and C.4.c of this Part above, the Permittee shall collect a groundwater sample from the impacted well(s) and analyze the sample(s) for the water quality parameters in Table 8.
- ii. The Permittee must continue to analyze groundwater samples from impacted monitoring wells described under Section C.g.i of this Part above for the water quality parameters in Table 8 on a monthly basis until excursion parameter concentrations show decreasing concentrations for three consecutive weekly sampling periods required under Section C.4.c of this Part above. Table 8 water quality parameter analytical results must be used to calibrate the geochemical model required under Section C.5 of this Part below.
- iii. After the excursion is corrected, the Permittee must collect a final sample from each impacted non-injection interval monitoring well and analyze it for the water quality parameters in Table 8 to determine if additional aquifer remediation is required in the excursion-impacted area.

**Reason for Change:** Upon reviewing a comment from Powertech about this requirement (#99 in Table 1 of Powertech’s 2019 comments on the second draft Class III Area Permit), EPA realized the language in former sections C.4.f.i and C.4.f.ii were redundant. Therefore, EPA revised the requirement to remove the redundancy. EPA also revised the requirement to be consistent with Change #88 to the Class III Permit below by requiring analysis for ISR contaminants in Appendix B, Table B-1 instead of Table 8 water quality parameters.

## 86. Part IX, Section C.5:

### Draft language:

5. Geochemical Modeling for Expanding Excursion Plumes
  - a. If concentrations of excursion parameters increase for four consecutive weeks or if an expanding plume expands further to include an adjacent monitoring well, then the Permittee shall update the Conceptual Site Model with the excursion information and develop a reactive transport model to evaluate the characteristics and potential extent of the expanding excursion plume and to evaluate the potential of the excursion plume to cross the aquifer exemption boundary and impact down-gradient USDWs.

### Final language:

5. Geochemical Modeling for Expanding Excursion Plumes
  - a. If monitoring under Section C.4.f of this Part shows that concentrations of ISR contaminants included in Appendix B, Table B-1 are detected above background in a monitoring well impacted by an expanding excursion plume, the Permittee must notify the Director within 24 hours as required by Section E.9.d.i of this Part.
  - b. The background concentration for an ISR contaminant is the Commission-approved background concentration for that monitoring well determined according to NRC License condition 11.3.
  - c. The Permittee must conduct the following verification steps to determine if ISR contaminant concentrations exceed background concentrations:
    - i. If one ISR contaminant exceeds its background concentration by 20% or two or more ISR contaminants exceed background concentrations by 10%, within 48 hours the Permittee must collect a follow-up confirmation groundwater sample from the monitoring well and analyze it for the ISR contaminants with concentrations above background.
    - ii. If the second sample confirms elevated concentrations of ISR contaminants meeting criteria in Section C.5.c.i above, then the Permittee must initiate the activities under Section C.5.d below. If not, within 48 hours the Permittee must collect a third groundwater sample from the monitoring well and analyze it for the ISR contaminants with concentrations above background.
    - iii. If the third sample does not show ISR contaminant concentrations above background, then the Permittee does not need to initiate the activities under Section C.5.d below.
  - d. Upon verification that ISR contaminants have increased in concentrations above background concentrations, the Permittee must conduct the following activities:
    - i. As required by Section E.9.d.ii of this Part, the Permittee must notify the Director within 24 hours of receiving the verification sampling results and follow-up in 5 days with a brief written report providing a schedule for the following activities.
    - ii. The Conceptual Site Model must be updated with all available information list in Part IV, Section A.1 for the non-injection interval aquifer impacted by the expanding plume.
    - iii. The Permittee must initiate the geochemical modeling process.
  - e. The geochemical model must:
    - i. Be calibrated to flow and geochemical conditions present at the excursion site and excursion parameter concentrations measured in the monitoring well(s);

- ii. Evaluate the extent of the excursion plume;
  - iii. Determine the potential for the excursion plume to reach the aquifer exemption boundary at the current rate of expansion; and
  - iv. Estimate the concentrations of ISR contaminants at the aquifer exemption boundary, taking into account the effects of dispersion and natural attenuation based on the geochemistry of the aquifer unit.
- f. After reviewing the model results, the Director will determine what actions the Permittee should take to protect USDWs, including the installation of additional monitoring wells and aquifer remediation, if needed.

**Reason for Change:** Powertech requested that EPA remove requirements related to an expanding excursion plume, including the geochemical modeling requirements. (See Powertech’s 2019 comments on the second draft Class III Area Permit, 65 and 66). EPA did not remove these requirements but did reevaluate them to make sure the requirements were directly linked to the ultimate goal of determining the potential for ISR contaminants to cross the aquifer exemption boundary. As a result of this reevaluation, EPA redefined the trigger for initiating geochemical model development and linked it to the Appendix B, Table B-1 list of ISR contaminants rather than rely on excursion parameters concentrations. EPA determined that Commission-approved background concentrations are appropriate concentrations to use for these requirements because they are determined using statistical methods that have been reviewed and approved by NRC.

**87. Part IX, Section C.6:**

**Draft language:**

6. Requirement to Remediate Excursions

The Permittee must **implement corrective action for** an excursion and continue excursion monitoring at all impacted monitoring wells until the excursion parameter concentrations meet non-excursion levels for four consecutive monitoring periods in all impacted monitoring wells. Non-excursion levels means no single excursion parameter exceeds 20% of its UCL and no two excursion parameters exceed their respective UCLs in any monitoring well.

**Final language:**

6. Requirement to Remediate Excursions

The Permittee must **take appropriate action to recover** an excursion and continue excursion monitoring at all impacted monitoring wells until the excursion parameter concentrations meet non-excursion levels for four consecutive monitoring periods in all impacted monitoring wells. Non-excursion levels means no single excursion parameter exceeds 20% of its UCL and no two excursion parameters exceed their respective UCLs in any monitoring well.

**Reason for Change:** EPA changed the phrase “implement corrective action for” in Part IX, Section C.6, *Requirement to Remediate Excursions*, to “take appropriate action to recover” an excursion of injection zone fluids out of the intended wellfield area. As described in Changes #72 and #76 to the Class III Permit above, the term “corrective action” has specific meaning in UIC regulations and is not related to recovery of excursions.

**88. Part IX, Section D:**

**Draft language:**

2. The Permittee shall notify the Director within twenty-four (24) hours of any seismic event measuring **4.0** magnitude (MMI scale) or greater reported within two miles of the permit boundary according to Part XII, Section D.11.e of this permit.
3. If any seismic event of magnitude **4.0** (MMI scale) or greater is reported within two miles of the permit boundary, the Permittee shall immediately cease injection.

**Final language:**

2. The Permittee must notify the Director within twenty-four (24) hours of any seismic event measuring **4.5** magnitude (MMI scale) or greater reported within two miles of the permit boundary.
3. If any seismic event of magnitude **4.5** (MMI scale) or greater is reported within two miles of the permit boundary, the Permittee must immediately cease injection.

**Reason for Change:** EPA updated the magnitude of earthquakes that trigger the 24-hours reporting requirement and ceasing injection in Part IX, Sections D.2 and D.3 from 4.0 to 4.5 for the reasons stated in Change #80 to the Class III Permit above.

**89. Part IX, Section E.8.C.iii:**

**Draft language:**

- iii. Quarterly mechanical integrity test results, a list of any wells failing mechanical integrity test and **corrective** actions taken, and a list of wells anticipated to undergo mechanical integrity testing during the next quarter.

**Final language:**

- iii. Quarterly mechanical integrity test results, a list of any wells failing mechanical integrity test and **remedial** actions taken, and a list of wells anticipated to undergo mechanical integrity testing during the next quarter.

**Reason for Change:** EPA changed the term “corrective actions” in Part IX, Section E.8.C.iii. to “remedial actions.” As described in Change #76 of the Class III Permit above, “corrective action” has a specific meaning in UIC regulations, while “remedial action” is used to describe actions taken to repair an injection well to restore mechanical integrity.

**90. Part IX, Section E.8.c.vi:**

**Draft language:**

- vi. Post-restoration wellfield monitoring.

**Final language:**

- vi. Post-restoration wellfield **post-restoration stability** monitoring results.

**Reason for Change:** Updates to requirement Part IX, Section E.8.c.vi now clarify that the information required for inclusion in quarterly monitoring reports includes wellfield **post-restoration stability**

monitoring **results** to be consistent with the new requirements under Part IX, Section B.4 discussed under Change #84 to the Class III Permit above.

**91. Part IX, Section E.9.a and c.1:**

**Draft Language:**

**9. Excursion Reporting**

**a. Initial Excursion Reporting**

If an excursion has been confirmed under Section C.3 of this Part, the Permittee must notify the Director within 24 hours per Part XII, Section D.10.e and, within 5 days, follow up with a written report that provides the following information:

(. . .)

**c. Reporting an Expanding Excursion Plume**

- i. If an expanding excursion is verified as described in Section C.4.e of this Part, the Permittee must notify the Director of an expanding excursion plume within 24 hours per Part XII, Section D.10.e and follow up with a written report within 5 days.

**Final Language:**

**9. Excursion Reporting**

**a. Initial Excursion Reporting**

If an excursion has been confirmed under Section C.3 of this Part, the Permittee must notify the Director within 24 hours per Part XI, Section C.4.a and, within 5 days, follow up with a written report that provides the following information:

(. . .)

**c. Reporting an Expanding Excursion Plume**

- i. If an expanding excursion is verified as described in Section C.4.f of this Part, the Permittee must notify the Director of an expanding excursion plume within 24 hours per Part XI, Section C.4.a and follow up with a written report within 5 days.

**Reason for changes:** As stated in Change #85 to the Class III Permit above, the twenty-four reporting requirement in UIC regulation § 144.51(l)(6) (under Part XII, Section D.10.e of the Class III Area Permit) applies only to non-compliances with UIC permit requirements or regulations. An excursion event is not a non-compliance with Class III Area Permit conditions or a violation of UIC regulations unless ISR contaminants cross the aquifer exemption boundary. Because EPA moved the requirement for reporting a confirmed excursion to the Director within twenty-four hours to Part IX, Section C.4.a, these requirements have been updated to be consistent with the change under Part IX, C.4.a.

**92. Part IX, Section E.9.b:**

**Draft language:**

- i. Within 60 days of the excursion confirmation, the Permittee shall submit a written report describing the excursion event, **corrective** actions taken and the corrective action results.
- ii. If monitoring wells are still on excursion status when the report is submitted, the report will also



contain a schedule for submittal of future reports describing the excursion event, **corrective** actions taken, and results obtained

**Final language:**

- i. Within 60 days of the excursion confirmation, the Permittee must submit a written report describing the excursion event, **recovery** actions taken and the recovery action results.
- ii. If monitoring wells are still on excursion status when the report is submitted, the report will also contain a schedule for submittal of future reports describing the excursion event, **recovery** actions taken, and results obtained.

**Reason for Change:** EPA has changed the term “corrective action” in these requirements to “recovery action.” As discussed under Change #72 to the Class III Permit above, the term “corrective action” has specific meaning in UIC regulations and is not related to recovery of excursions.

**93. Part IX, Section E.9.d:**

**Draft language:**

d. Reporting Increase in Concentration of Excursion Indicators in Impacted Monitoring Wells

If concentrations of excursion parameters increase for four consecutive weeks or if an expanding plume expands further to include an adjacent monitoring well, then the Permittee shall notify the Director within 24 hours per Part XII, Section D.11.e and, within 5 days, follow up with a written reporting that includes a discussion of the Permittee’s plans to comply with Sections C.5 and C.6 of this Part and develop a reactive transport model of the expanding excursion plume.

**Final language:**

**d. Reporting Increase in Concentration of ISR Contaminants in Impacted Monitoring Wells**

- i. The Permittee must notify the Director within 24 hours as required by Section C.5.a of this Part if monitoring under Section E.4.f of this Part shows that concentrations of ISR contaminants included in Appendix B, Table B-1 are detected above background in a monitoring well impacted by an expanding excursion plume.
- ii. As required by Section C.5.d.i of this Part, the Permittee must notify the Director within 24 hours of receiving the verification sampling results and follow-up in 5 days with a brief written report providing a schedule for the following activities:
  - A) The Conceptual Site Model must be updated with all available information list in Part IV, Section A.1 for the non-injection interval aquifer impacted by the expanding plume.
  - B) The Permittee must initiate the geochemical modeling process.

**Reason for Change:** This reporting requirement has been updated to be consistent with the changes to Class III Area Permit requirements under Part IX, Section C.5, where EPA redefined the trigger for initiating geochemical model development. See Change #88 to the Class III Permit above.

**94. Part XII, Section D.10.e (and formerly g):**

**Draft Language:**

e. Twenty-four hour reporting. The Permittee must report to the Director within 24 hours any noncompliance which may endanger human health or the environment, including, but not limited to:

- i. Any monitoring or other information which indicates that any contaminant may cause endangerment to a USDW; or
- ii. Any noncompliance with a permit condition or malfunction of the injection system which may cause fluid migration into or between USDWs.

(. . .)

g. In addition, a follow up written report must be provided to the Director within five (5) days of the time the Permittee becomes aware of the circumstances. The written submission must contain a description of the noncompliance and its cause, the period of noncompliance including exact dates and times, and if the noncompliance has not been corrected the anticipated time it is expected to continue; and the steps taken or planned to reduce, eliminate, and prevent recurrence of the noncompliance.

**Final Language:**

e. Twenty-four hour reporting. The Permittee must report to the Director any noncompliance which may endanger human health or the environment, including:

- i. Any monitoring or other information which indicates that any contaminant may cause endangerment to a USDW; or
- ii. Any noncompliance with a permit condition or malfunction of the injection system which may cause fluid migration into or between USDWs.

In addition, a follow up written report must be provided to the Director within five (5) days of the time the Permittee becomes aware of the circumstances. The written submission must contain a description of the noncompliance and its cause, the period of noncompliance including exact dates and times, and if the noncompliance has not been corrected the anticipated time it is expected to continue; and the steps taken or planned to reduce, eliminate, and prevent recurrence of the noncompliance.

**Reason for Change:** UIC regulation 40 CFR § 144.51 Conditions applicable to all permits, (i) Reporting requirements, (6) Twenty-four hour reporting was incorrectly divided into two requirements in the Class III Area Permit, Part XII, Sections D.10.e and g. The result of this division was that it was not clear that the follow-up written report due 5 days after a 24-hour verbal report was linked to the 24-hour reporting requirement. In order to be consistent with the mandatory regulatory language from 40 CFR § 144.51, EPA corrected this error in the final permit by incorporating the language under former requirement Part XII, Section D.10.g into requirement Part XII, Section D.10.e.

**95. Part XIV. Compliance with Applicable Federal Laws, Section A:**

**Draft language:**

A. The National Historic Preservation Act (NHPA) of 1966, 16 U.S.C. 470 et seq.

(. . .)

1. The Permittee shall abide by the stipulations of the Programmatic Agreement (PA) among U.S. Nuclear Regulatory Commission, U.S. Bureau of Land Management, South Dakota State Historic Preservation Office, Powertech (USA), Inc. and Advisory Council on Historic Preservation Regarding the Dewey-Burdock In-Situ Recovery Project Located in Custer and Fall River Counties South Dakota (PA) dated March 19, 2014, and the EPA addendum to the PA.

**Final language:**

A. The National Historic Preservation Act (NHPA) of 1966, 16 U.S.C. 470 et seq.

(. . .)

1. The Permittee must abide by the stipulations of the Programmatic Agreement (PA) among U.S. Nuclear Regulatory Commission, U.S. Bureau of Land Management, South Dakota State Historic Preservation Office, Powertech (USA), Inc. and Advisory Council on Historic Preservation Regarding the Dewey-Burdock In-Situ Recovery Project Located in Custer and Fall River Counties South Dakota (PA) dated March 19, 2014 and adopted by EPA on November 13, 2020.

**Reason for Change:** On November 13, 2020, EPA adopted the Programmatic Agreement described in the permit requirement without adding an EPA addendum and updated measure 1 accordingly.

**96. Part XIV. Compliance with Applicable Federal Laws, Section B:**

**Draft language:**

A. The Endangered Species Act (ESA), 16 U.S.C. 1531 et seq.

Section 7 of the ESA and its implementing regulations (50 CFR part 402) require the EPA to ensure, in consultation with the Secretary of the Interior or Commerce, that any action authorized by EPA is not likely to jeopardize the continued existence of any endangered or threatened species or adversely affect its critical habitat.

The Permittee shall comply with the following mitigation measures:

1. If the whooping crane, the rufa red knot or the northern long-eared bat are sighted within one mile of the UIC well sites or associated facilities during construction or operation, all work within one mile of the species' location must cease, and the Permittee must contact the Director and the USFWS immediately. In coordination with the USFWS, work may resume after the terrestrial species leave the area.
2. Any wells, equipment or buildings associated with the UIC wells authorized under the permit with a fixed location within the project area must be constructed to eliminate openings that look like a small cave or hibernacle to avoid the entrance of any northern long-eared bat.
3. In the event that construction is planned during the migratory bird nesting and breeding season, a qualified biologist must conduct pre-construction surveys for migratory birds and their nests within five days prior of the initiation of any construction activities.
4. Spills or leaks of chemicals and other pollutants at the UIC well site must be reported to the appropriate regulatory agencies. The procedures of the surface management agency must be followed to contain leaks or spills.

5. If supplemental lighting is used during construction or operation, the lights must be directed and/or sheltered to minimize the amount of light escaping the work or project site.
6. The Permittee shall install netting, use bird balls or other acceptable bird deterrent method to prevent birds and bats from accessing the ponds.
7. Tree removal activities must be conducted outside of the northern long-eared bat active season (April 1 to October 31). This will minimize impacts to northern long-eared bat pups at roosts not yet identified.
8. During the northern long-eared bat active season (April 1 to October 31), the Permittee shall use a motion-activated camera to monitor the Triangle Mine vertical ventilation shaft located at NWNW Section 35, T6S, R1E for 5 days and nights and determine if bats are entering and exiting. If no bats are observed entering or exiting the shaft, the Permittee shall investigate the shaft to determine if bats are inside the shaft. If no bats are inside the shaft, the Permittee shall cover the entrance to the shaft with finer mesh to prevent bats from entering. If bats are observed in the shaft, the Permittee shall work with South Dakota Game, Fish and Parks to evaluate methods for establishing an appropriate buffer zone around the shaft to prevent tree removal or wellfield construction activity. The buffer zone will need to take into account the fact that the shaft is only a few feet away from a road that is used by local residents and may be improved to use as an access road to the Project Site.

**Final language:**

**B. The Endangered Species Act (ESA), 16 U.S.C. 1531 et seq.**

Section 7(a)(2) of the ESA and its implementing regulations (50 CFR part 402) require EPA to ensure, in consultation with the Secretary of the Interior or Commerce, that any action authorized by EPA is not likely to jeopardize the continued existence of any endangered or threatened species or result in the destruction or adverse modification of designated critical habitat for such species.

1. EPA incorporates the following measures in the UIC permits to avoid, minimize or mitigate any potential impacts to federally-listed species:
  - a. In the event that construction is planned during the whooping crane and rufa red knot migration seasons or the northern long-eared bat (NLEB) active season, within five days prior to the initiation of any construction activities, a qualified biologist must conduct pre-construction surveys for these species and training for workers to assist with the identification of all listed species during construction and operation.
    - i. Whooping crane migration seasons: migrates through South Dakota April 1 to mid-May and mid-September to mid-November.
    - ii. Rufa red knot migration seasons: migrates through South Dakota mid-April to mid-May and mid-September to October 31.
    - iii. NLEB active season: mid-April to October 31. The critical pup season is June 1 – July 31.
  - b. If the whooping crane, the rufa red knot or the northern long-eared bat are sighted within one-half mile of the well sites or associated facilities during construction or operation, the Permittee must contact EPA and the FWS immediately and all construction work within one-half mile of the species' location must cease. Powertech will work with the FWS and a

qualified biologist to minimize surface operation activities within one-half mile of the species' location. In coordination with the FWS, work may resume after the species leave the area. For this measure and other ESA-related matters related to this project, the Permittee should contact the FWS and EPA by phone, followed up by an e-mail. The contact points are:

- The FWS South Dakota Field Office – (605) 224-8693, email: [southdakotafieldoffice@fws.gov](mailto:southdakotafieldoffice@fws.gov)
  - EPA Region 8 UIC Program – (303) 312-6079, email: [minter.douglas@epa.gov](mailto:minter.douglas@epa.gov)
- c. Any wells, equipment or buildings associated with the UIC wells authorized under the permit with a fixed location within the project area must be constructed to eliminate openings that look like a small cave or hibernacle to avoid the entrance of any northern long-eared bats.
  - d. Spills or leaks of chemicals and other pollutants at the UIC well site must be reported to the appropriate regulatory agencies. The procedures of the surface management agency must be followed to contain leaks or spills.
  - e. If supplemental lighting is used during construction or operation activities, as a protection measure for northern long-eared bat, the lights must be directed and/or sheltered to minimize the amount of light escaping the work or project site.
  - f. The Permittee must install netting, use bird balls or other acceptable bird deterrent method to prevent birds and bats from accessing all project ponds.
  - g. Tree removal activities within the project area must be conducted outside of the northern long-eared bat active season (mid-April to October 31). This will minimize impacts to the northern long-eared bat, including to NLEB pups during the critical pup season.
  - h. During the northern long-eared bat active season (mid-April to October 31), the Permittee must use a motion-activated camera to monitor the Triangle Mine vertical ventilation shaft located at NWNW Section 35, T6S, R1E for 5 days and nights and determine if bats are entering and exiting. If no bats are observed entering or exiting the shaft, the Permittee must investigate the shaft to determine if bats are inside the shaft. If no bats are inside the shaft, the Permittee must cover the entrance to the shaft with finer mesh to prevent bats from entering. If bats are observed in the shaft, the Permittee must work with South Dakota Game, Fish and Parks to evaluate methods for establishing an appropriate buffer zone around the shaft to prevent tree removal or wellfield construction activity. The buffer zone will need to take into account the fact that the shaft is only a few feet away from a road that is used by local residents and may be improved to use as an access road to the Project Site.

**Reason for Changes:** In 2020, EPA prepared a revised Biological Assessment in consideration of comments received during the public comment period on the draft UIC permits and aquifer exemption and based upon further research and discussions with the FWS. The updated BA analyzes the potential impacts of the EPA actions on federally-listed species and includes these revised mitigation measures. The FWS provided written concurrence with EPA's determination that its actions that include these measures "may affect, but are not likely to adversely affect," the rufa red knot, northern long-eared bat and whooping crane. For additional information about changes to individual mitigations measures, see EPA's responses to these comments: #382, #383, #384, #385, #386.

**97. PART XIV, Section B.2:**

**Draft Language:** none

**Final Language:**

**2. Record Keeping and Retention Requirements for Endangered Species Act Mitigation**

The Permittee must document all activities related to compliance with Part XIV, Section B of this Permit. All records of such documentation must be retained and made available for inspection or upon request by the Director. The Permittee must notify the Director as to the location where the records of ESA mitigation activities are maintained and notify the Director if this location changes. All records must be retained until all wells have been plugged and abandoned after which the owner or operator must deliver the records to the Director or obtain written approval from the Director to discard the records.

**Reason for Change:** EPA has included this new requirement to ensure adequate documentation and record retention for activities performed in compliance with the permit requirements related to the protection of federally-listed species.

**98. Appendix B:**

**Draft Language:**

**APPENDIX B  
Cadmus Report on Acceptance Criteria for the Geochemical Model**

**Final Language:**

**Appendix B**

**Table B-1. List of ISR Contaminants, Permit Limits and Required Analytical Method Detection Limit**

Test Analyte/Parameter*	Permit Limit (mg/L)	Standard Type
Antimony, Sb	0.006	MCL <sup>1</sup>
Arsenic, As	0.01	MCL
Barium, Ba	2	MCL
Beryllium, Be	0.004	MCL
Boron, B	6	HA-L <sup>2</sup>
Cadmium, Cd	0.005	MCL
Chromium, Cr	0.1	MCL
Copper, Cu	1.3	LCR-Action Level <sup>3</sup>
Fluoride, F	4	MCL
Iron, Fe	5	R8-HBS <sup>4</sup>
Lead, Pb	0.015	LCR-Action Level <sup>3</sup>
Manganese, Mn	0.1	R8-HBS <sup>4</sup>
Mercury, Hg	0.002	MCL
Molybdenum, Mo	0.04	HA-L
Nickel, Ni	0.1	HA-L

Nitrate, NO <sub>3</sub> <sup>-</sup> (as Nitrogen)	10	MCL
pH	6.5-8.5	SMCL <sup>5</sup>
Radium-226 + Radium-228	5 pCi/L (converted to mg/L)	MCL
Selenium, Se	0.05	MCL
Silver, Ag	0.1	HA-L
Sodium, Na	20	HBS <sup>6</sup>
Strontium, Sr	4	HA-L
Sulfate, SO <sub>4</sub>	500	HBS <sup>7</sup>
TDS	500	SMCL <sup>5</sup>
Thallium, Tl	0.002	MCL
Uranium, U	0.03	MCL
Vanadium, V	0.3	ATSDR MRL <sup>8</sup>
Zinc, Zn	2	HA-L

<sup>1</sup>MCL – Maximum Contaminant Level or Primary Drinking Water Standard

<sup>2</sup>HA-L – Health Advisory – Lifetime

<sup>3</sup>LCR-Action Level – Lead and Copper Rule action level

<sup>4</sup>R8-HBS – EPA Region 8 Health-Based Standard

<sup>5</sup>Secondary MCL

<sup>6</sup>EPA, 2003, Drinking Water Advisory: Consumer Acceptability Advice and Health Effects Analysis on Sodium, EPA 822-R-03-006, 29 p.

<sup>7</sup>EPA, 2003, Drinking Water Advisory: Consumer Acceptability Advice and Health Effects Analysis on Sulfate, EPA 822-R-03-007, 29 p.

<sup>8</sup>Based on Agency for Toxic Substances and Disease Registry oral intermediate Minimum Risk Level of 0.01 mg/kg-day using 80 kg and 2.4 L/day

**Reason for Change:** Appendix B now contains Table B-1, the List of ISR Contaminants, Permit Limits and Required Analytical Method Detection Limit for reasons discussed under Change #12 to the Class III Permit above.

**Typos and other editorial changes**

Permit Section	Change
Part I	“p” in “parts” not capitalized for parts 2, 124, 144, 146, and 147
Part I	“s” in “section” not capitalized for section 1431
Part II, Section C.2.a	“s” added to “location”
Part II, Section D.4.d	The “i” in “if” after the colon in the first line is now capitalized.
Part II, Section E.2.b	“provided” changed to “provide” in third line under b.
Part II, Section E.2.b.i	In the last line before A) “each well” has been changed to “each of these wells” for clarification purposes.
Part II, Table 8	The space between “Ca” and “CO <sub>3</sub> ” has been omitted for Total Alkalinity (as CaCO <sub>3</sub> ), Bicarbonate Alkalinity (as CaCO <sub>3</sub> ) and Carbonate Alkalinity (as CaCO <sub>3</sub> ).
Part II, Table 8	The initial “a” in “alkalinity” has been capitalized in “Total Alkalinity.”

Part II, Table 8	“?~” have been removed after the heading “Dissolved Metals”
Part II, Table 8, Gross Beta units of measure	The units of measure incorrectly listed as <i>pCi/L</i> in the draft permit have been corrected to be <i>mRem/Year</i> to be consistent with the MCL.
Part II, Section G.7	“has” has been changed to “have”
Part III, Section B.8	Spelling of “Occurring” corrected
Part III, Section D.1	(Formerly Part III, Section C.1) “Section H.q” has been changed to “Section H.3.r” to refer to the correct section.
Part IV, Section A.2	“Conceptual Site Model” has been abbreviated as CSM.
Part IV, Section A.2.c.i.C) Part IV, Section C.1.b Part IV, Section D.1.a	“post-” has been added to “restoration stability monitoring” for consistency and clarification.
Part IV, Section D.1	Deleted “!~” after section heading
Part V, Section H.c	Reference to Part IX, Section B.3 has been changed to Part IX, Section B.2 because former Part IX, Section B.2 has been deleted.
Part VI, Section B.5	“If a mechanical” has been changed to “If mechanical.”
<i>References to Part XII, Section D.11 have been changed to Part XII, Section D.10 in the following locations</i>	
Part VII, Section I.1	
Part XI, Section B.1, Table 14 H	
Part XI, Section D.2	
Part XII, Section 10.j	
Part VIII, Section F.5.c	Reference to Table 14, D has been changed to Table 14, F
Part VIII, Section, F.6.d	“Post-Restoration” has been added to Stability Monitoring for consistency and clarification
Part IX, Table 14F Title	“Post-Restoration” has been added to “Stability Monitoring” for consistency and clarification
Part IX, Table 14G, <i>Report</i>	“Post-Restoration” has been added to stability monitoring for consistency and clarification
Part IX, Section B.2.a.i	“within” has been added
Part IX, Section B.2.c	Requirements under Part IX, Section B.2.c (formerly Section B.3.c), <i>Operational Groundwater Monitoring for Monitoring Wells</i> , have been bulletized i through iv.
Part IX, Section C.2 heading	“Post-Restoration” has been added to stability monitoring for consistency and clarification
Part IX, Section C.2.a	“ISR operations” has been changed to “groundwater restoration and post-restoration stability monitoring” to be consistent with the section heading.
Part IX, Section C.4.d	Reference to sections “a and b” have been updated to “Sections C.4.a and C.4.b” to be consistent with format used for internal references.
Part IX, Section C.4.f.ii	“Section 5” updated to “Section C.5 of this Part” to be consistent with format used for internal references.
PART IX. Section E.3 PART IX. Section E.6 PART IX. Section E.8.d	References to Part XII, Section E.10 have been changed to reference Part XII, Section E.9. Reference to D.10.b has been changed to D.9.d.



Part IX, Section E.4	The bullets under 4 have been corrected to begin with a instead of d.
Part XII, Section D.10	References to Part XII, Section E.10 have been changed to reference Section E.9
Part XII, Section D.10.i	(formerly Part XII, Section D.10.j) Reference to Section D.10.i has been changed to Section D.10.h because of changes in bullet lettering due to Change #96 to the Class III Permit above.
Part XIII, Section A	Lowercase bullets a through c directly under Section A were changed to dotted bullets to be more consistent with document formatting.
Part XIII, Section A, first two dotted bullets	"40 CFR" was added in front of regulation citations to be consistent with other regulation citations.
Part XIII, Sections A.1	The "§" symbol was added to 40 CFR § 144.70 citations to be consistent with other regulation citations.

### Changes to the Class V Area Permit

1. EPA changed uses of "shall" in the Permit to "must" to indicate required actions by the Permittee.

**Reason for change:** In keeping with the federal government's plain language guidelines (see [www.plainlanguage.gov](http://www.plainlanguage.gov)), and the Plain Language Act of 2010, this is to provide greater clarity, as "shall" is ambiguous.

2. **Cover pages and Part I Introduction:**  
The operator's address was updated.

**Draft Permits:**

Powertech (USA) Inc.  
5575 DTC Parkway, Suite 140,  
Greenwood Village, Colorado 80111

**Final Permits:**

Powertech (USA) Inc.  
P.O. Box 448  
Edgemont, SD 57735

**Reason for change:** To provide the Permittee's updated address.

3. **Part I, Signature pages:**

**Draft language:**

\*NOTE: Throughout this Permit the term "Director" refers to either the Chief of the Safe Drinking Water Branch of the Water Division or the Chief of the Water Enforcement Branch of the Enforcement and Compliance Assurance Division.

**Final language:**

NOTE: Throughout this Permit the term "Director" refers to either the Director of the Water Division (or authorized representative) or the Chief of the Water Enforcement Branch of the Enforcement and Compliance Assurance Division (or authorized representative).

**Reason for change:** To provide greater clarity on who in EPA can be defined as "Director" for purposes of this permit, in accordance with Delegations of Authority.

4. References to EPA in its role as UIC Program Director were replaced with “Director” at the following places:

**Class V Area permit:**

Part II, Section I.4.c (formerly Part II, Section J.4.c)  
 Part III, Section K.1,  
 Part V, Section C.6.b.iii, and  
 Part VI, Section A

**Reason for change:** To improve internal consistency within the Permit.

5. **Part I, Section B and Table 1**

**Draft language:**

B. Well Locations

Approximate location information for the two proposed Class V injection wells is shown in Table 1.  
 (. . .)

Table 1. Injection Wells Proposed under the Class V Area Permit

Well Permit Number	Well Name	Approximate Latitude	Approximate Longitude	Proposed Injection Zone	Anticipated Injection Zone Depth (ft below ground surface)	Location within Permit Area
SD52173-08764	DW No. 1	43.469772181	-103.971938654	Minnelusa Formation	~1,615 - 2,355'	Burdock Area
SD52173-08766	DW No. 3	43.4971737527	-104.031570321	Minnelusa Formation	~1,950 - 2,704'	Dewey Area

**Final language:**

B. Well Location

Approximate location information for the proposed DW No. 1 Class V injection well is shown in Table 1.  
 (. . .)

Table 1. DW No. 1 Injection Well Proposed under the Class V Area Permit

Well Permit Number	Well Name	Approximate Latitude	Approximate Longitude	Proposed Injection Zone	Anticipated Injection Zone Depth (ft below ground surface)	Location within Permit Area
SD52173-08764	DW No. 1	43.469772181	-103.971938654	Minnelusa Formation	~1,615 - 2,355'	Burdock Area

**Reason for change:**

Specifications for injection well DW No. 3 were removed because demonstration of financial responsibility (FR) for this well was not presented by the Permittee. EPA is requiring an initial adequate demonstration of FR prior to final UIC permit issuance, which is consistent with EPA’s UIC regulatory authority found in 40 CFR § 144.52(a)(7) and its longstanding practice for the proposed operation of relatively deep disposal wells. Other references to DW No. 3 or multiple wells were updated in the Permit as follows:

Draft Permit	Change
Figure 1	Site 2 for DW No. 3 removed from Dewey-Burdock Class V Area Permit Boundary
Table 6	DW No. 3 removed from Aquifer to be Tested
Part II, Section E.1.a	Reference removed
Part II, Section F.1	Reference removed
Table 11	Well Casing and Cement Summary for DW No. 3 removed
Figure 4	DW No. 3 Well Construction Schematic removed
Part III, Section B	Reference to Figure 4 removed
Part IV, Section F.2	Text revised to reflect that only 1 well is shown in Table 1: The approximate depth to the injection zone for well DW No. 1 is shown in Table 1 of this Area Permit.

## 6. Part II, Section A (formerly A.1 and A.2)

### Draft language:

#### A. Injection Authorization Data Package Report

1. Information to Submit to the Director to Obtain a Limited Authorization to Inject for Testing Purposes

For each injection well, the Permittee shall provide the following information, further described in Sections B through H, to the Director for evaluation. After evaluating the information, the Director will determine if it is appropriate to issue a written Limited Authorization to Inject to authorize the Permittee to commence injection activity for testing purposes only.

(. . .)

- i. The testing procedures, results and interpretation of results for the formation testing required under Part II, Section D shall be included in the Injection Authorization Data Package Report.
2. Information to Submit to the Director to Obtain an Authorization to inject
  - a. After obtaining the Limited Authorization to Inject, the Permittee shall inject only for the purpose of conducting the following tests:
    - i. Step Rate Test and
    - ii. Initial Radioactive Tracer Survey
  - b. The Permittee shall provide the testing results to the Director for evaluation as required under Part II Section K.1.

### Final language:

#### A. Information to Submit to the Director to Obtain an Authorization to Inject

For each injection well, the Permittee must provide the following information, further described in Sections B through I, to the Director for evaluation. After evaluating the information, the Director will determine if it is appropriate to issue a written Authorization to Inject.

(. . .)

9. Results of step rate testing to determine the site-specific maximum allowable injection pressure (MAIP) for each well.

10. Results of a temperature survey or radioactive tracer survey for each injection well to establish a baseline assessment of Part II Mechanical Integrity and provide injectivity profile information.
11. The testing procedures, results and interpretation of results for the formation testing required under Part II, Section D must be included in the Injection Authorization Data Package Report.

**Reason for change:**

EPA received a comment expressing concern about the Limited Authorization to Inject (LATI) provisions. To provide consistency with standard injection well permit requirements, the separate process to obtain Limited Authorization to Inject for testing purposes was removed. Requirements under Part II, Section A.1 *Information to Submit to the Director to Obtain a Limited Authorization to Inject for Testing Purposes* were combined with those under Part II, Section A.2 *Information to Submit to the Director to Obtain an Authorization to inject*. The Permit authorizes the Permittee to inject for limited testing purposes but still requires a written authorization to inject prior to any other injection.

**7. Part II, Section J (formerly I and K)**

**Draft language:**

- I. Evaluation of the Injection Authorization Data Package Reports for Limited Authorization to Inject
  1. The Director will evaluate the information provided in the Injection Authorization Data Package Reports and may issue a written Limited Authorization to Inject for testing purposes only. The Director will issue Limited Authorization to Inject only after finding:
 

( . . . )

    - h. The well perforations are located within the approved injection zone with the top perforation no less than 50 feet below the base of the lowest USDW intersecting the well bore; and
    - i. The initial Temperature Survey Log provides baseline conditions for comparison with future logs required under Part V, Section C.6.c.
  2. The Limited Authorization to Inject shall have the following conditions:
    - a. The well perforations must be within the approved injection zone, and the top perforation must be at least 50 feet below the base of the lowest USDW intersecting the well bore;
    - b. The specific gravity of the test injectate shall be no higher than 1.0113; and
    - c. The test injectate shall meet the injectate permit limits in Part V, Section D.2.a Table 16.
- K. Information to Submit to the Director to Obtain Authorization to inject
  1. Well Testing Information

The Director will evaluate the information provided in the Injection Authorization Data Package Reports and may issue a written Authorization to inject for each injection zone only after finding:

- a. Both internal and external mechanical integrity are demonstrated for the injection well;

b. Step Rate Test data provide the injection zone fracture pressure for the injection well allowing the Director to set a permit limit for the maximum allowable injection pressure (MAIP) for the injection well calculated using the formula in Part II, Section J.4.b; and The initial Radioactive Tracer Survey provides baseline conditions for comparison with future test required under Part V, Section C.6.c.

**Final language:**

J. Evaluation of the Injection Authorization Data Package Reports

1. Well Testing Information

The Director will evaluate the information provided in the Injection Authorization Data Package Reports and may issue a written Authorization to Inject only after finding:

(. . .)

- h. The well perforations are located within the approved injection zone with the top perforation no less than 50 feet below the base of the lowest USDW intersecting the well bore;
- i. The initial temperature survey or radioactive tracer survey provides baseline conditions for comparison with future logs required under Part V, Section C.6.c;
- j. Both internal and external mechanical integrity are demonstrated for the injection well; and
- k. Step Rate Test data provide the injection zone fracture pressure for the injection well allowing the Director to set a permit limit for the MAIP for the injection well calculated using the formula in Part II, Section I.4.c.

**Reason for change:**

EPA received a comment expressing concern about the Limited Authorization to Inject (LATI) provisions. While in some cases, a LATI is a necessary tool to protect USDWs, EPA agrees that the Permit can provide the same protection to USDWs without this additional step. Requirements for LATI Package Reports described under Part II, Section I were combined with requirements for Authorization to Inject Package Reports under Section K to form updated section J in the Final Permit. Conditions related to LATI under Part II, Section I.2 were removed because separate testing for LATI is no longer required. These conditions already are required elsewhere within the Class V Area Permit and do not need to be restated as conditions for receiving ATI. Other references to the LATI process were updated as follows:

Draft Permit section	Change made
Table 2	Due Date: Prior to receiving <del>Limited</del> Authorization to Inject
Table 5	Due Date: Prior to receiving <del>Limited</del> Authorization to Inject
Table 7	Due Date: Prior to receiving <del>Limited</del> Authorization to Inject
Part II, Section J.2	Limited injection is permissible prior to receiving authorization to inject only for the purposes of conducting the formation testing listed in Table 10.
Table 10	Due Date: Prior to receiving Authorization to Inject.

**8. Part II, Section C, Table 4. Long String Casing: Open Hole Logs**

**Draft Language:**

TYPE OF LOG	PURPOSE	DUE DATE
Fracture Finder	Open-hole formation evaluation	Prior to setting long string casing

**Final Language:**

TYPE OF LOG	PURPOSE	DUE DATE
Fracture Finder (Micro-resistivity)	Open-hole formation evaluation	Prior to setting long string casing

**Reason for change:** The term “Micro-resistivity” was added after “Fracture Finder” to provide clarification of the method.

**9. Part II, Section D.1, Table 6. Aquifer to be Tested**

**Draft Language:**

Well Drill Hole	Aquifers to be Tested
DW No. 1	Each discreet Minnelusa perforated interval
DW No. 3	Each discreet Minnelusa perforated interval
Madison water supply wells (if constructed).	Each discreet Minnelusa interval correlating to the perforated intervals in the injection wells, Madison aquifer

**Final Language:**

Well Drill Hole	Aquifers to be Tested	
DW No. 1	Each perforated zone in the Minnelusa Formation separated by a confining layer	
Madison water supply wells (if constructed).	Madison water supply wells (if constructed).	Stratigraphic intervals correlating to each perforated zone in the Minnelusa Formation separated by a confining layer at the injection wells, Madison aquifer

**Reason for change:**

In response to a comment by Powertech, “discreet perforated intervals” have been re-characterized to say: “Each perforated zone in the Minnelusa Formation separated by a confining layer.” This was changed to improve clarity and allow a single sample to be collected from across perforated intervals in the absence of a confining layer between perforated intervals, which is in accordance with the purpose of the testing described in the tables.

**10. Part II, Section D.1, Table 7. Formation Testing Program**

**Draft language:**

TYPE OF TEST	PURPOSE	DUE DATE
Open-hole fluid samples shall be taken from each aquifer listed in Table 6 according to the requirements under Part II, Section D.2.	To allow Powertech to characterize the water quality from each aquifer specified in Table 6 prior to perforating and swab sampling.	Prior to receiving Limited Authorization to Inject
Cased-hole swab samples shall be taken from each Minnelusa perforated interval specified in Table 6 according to the requirements under Part II, Section D.2.	To demonstrate that each injection interval is not an USDW	Prior to receiving Limited Authorization to Inject
Cased-hole potentiometric surface will be measured for each separate perforated interval	To determine potentiometric surface for each injection interval	Prior to receiving Limited Authorization to Inject
Further characterization of each Minnelusa Injection interval with respect to Bicarbonate, Calcium, Carbonate, Chloride, Fluoride, Magnesium, Potassium, Sodium and Sulfate concentrations. Report results as mg/L, milliequivalents per liter and plot as STIFF diagram show in Figure 2.	To verify the Minnelusa injection interval and Madison aquifer are hydrologically separated as described in Part II, Section E.3.	Prior to receiving Limited Authorization to Inject
Characterization of the Madison Formation water at the Madison water supply wells (if constructed), with respect to Bicarbonate, Calcium, Carbonate, Chloride, Fluoride, Magnesium, Potassium, Sodium and Sulfate concentrations. Report results as mg/L, milliequivalents per liter and plot as STIFF diagram show in Figure 2.	To verify the Minnelusa injection interval and Madison aquifer are hydrologically separated as described in Part II, Section E.3.	Within 30 days of acquisition of data
Madison water supply wells (if constructed). Measurement of additional parameters in the Madison aquifer required for updating the drawdown model of the Madison aquifer potentiometric surface described in Section 4.0 of the <i>Report to Accompany Madison Water Right Permit Application</i> submitted to the DENR Water Rights Program using site specific data.	To provide the input parameters for the drawdown model that will determine the expected drawdown in the Madison aquifer at each Madison water supply well with 12 years of pumping.	Within 30 days of acquisition of data.
Initial Temperature Survey Log <sup>3</sup>	To establish baseline temperatures of formations along well bore.	Prior to receiving Limited Authorization to Inject

**Final language:**

TYPE OF TEST	PURPOSE	DUE DATE
Open-hole fluid samples may be taken at the Permittee’s discretion from each aquifer listed in Table 6 according to the requirements under Part II, Section D.2.	To allow Powertech to characterize the water quality from each aquifer specified in Table 6 prior to perforating and swab sampling.	Prior to receiving Authorization to Inject
Cased-hole swab samples must be taken from each Minnelusa perforated zone specified in Table 6 according to the requirements under Part II, Section D.2.	To demonstrate that each injection zone is not an USDW	Prior to receiving Authorization to Inject
Cased-hole potentiometric surface will be measured for each separate perforated zone	To determine potentiometric surface for each injection zone	Prior to receiving Authorization to Inject
Further characterization of each Minnelusa Injection zone with respect to Bicarbonate, Calcium, Carbonate, Chloride, Fluoride, Magnesium, Potassium, Sodium and Sulfate concentrations. Report results as mg/L, milliequivalents per liter and plot as STIFF diagram show in Figure 2.	To verify the Minnelusa injection zone and Madison aquifer are hydrologically separated as described in Part II, Section E.3.	Prior to receiving Authorization to Inject
Characterization of the Madison Formation water at the Madison water supply wells (if constructed), with respect to Bicarbonate, Calcium, Carbonate, Chloride, Fluoride, Magnesium, Potassium, Sodium and Sulfate concentrations. Report results as mg/L, milliequivalents per liter and plot as STIFF diagram show in Figure 2.	To verify the Minnelusa injection zone and Madison aquifer are hydrologically separated as described in Part II, Section E.3.	Within 30 days of acquisition of data
Madison water supply wells (if constructed). Measurement of additional parameters in the Madison aquifer required for updating the drawdown model of the Madison aquifer potentiometric surface described in Section 4.0 of the Report to Accompany Madison Water Right Permit Application submitted to the DENR Water Rights Program using site specific data.	To provide the input parameters for the drawdown model that will determine the expected drawdown in the Madison aquifer at each Madison water supply well with 10 years of pumping.	Within 30 days of acquisition of data
Initial Temperature Survey Log <sup>3</sup>	To establish baseline temperatures of formations along well bore.	Prior to receiving Authorization to Inject

**Reason for change:** To provide for the possibility that open-hole sampling may not be achievable, Powertech requested that requirements for open-hole fluid sampling be removed from the permit



or that such sampling be at their discretion. Collecting an open-hole sample is no longer required but may be taken at the Permittee's discretion to provide flexibility for preliminary characterization of injection zones prior to perforating and swab sampling. Collection of open-hole samples is not a vital component of the formation testing program. The word "interval," as it relates to the injection interval, was replaced with "zone" to be consistent with changes in Table 6. This word replacement also was done in Part II, Sections A.1, B.4 (including Table 2), C.3, D.2, E.3, F.1, and I.1, as well as Part IV, Section F.2, for consistency with Tables 6 and 7. Similarly, the term "Minnelusa interval" was replaced with "Minnelusa injection zone" in Part II, Sections D.3 and I.1 and Part IV, Section E for clarity and consistency.

## **11. Part II, Sections D.2.a and D.2.b**

### **Draft language:**

#### **2. Aquifer Fluid Sampling Requirements**

- a. The drilling program for each well shall include the addition of a fluorescent dye tracer in the drilling fluids. The fluorescent dye tracer used for this purpose shall be such that the Permittee is able to analyze for the presence of the tracer in aquifer fluid samples using field testing methods. The tracer shall also be included as an analyte for laboratory testing of formation fluids to verify that no drilling fluid residual is present in the formation fluid samples.
- b. Before aquifer sample collection, each aquifer shall be isolated within the drill hole to prevent inflow of groundwater from other aquifers.

### **Final language:**

#### **2. Aquifer Fluid Sampling Requirements**

- a. The drilling program for each well must include the addition of a fluorescent dye tracer in the drilling fluids. The fluorescent dye tracer used for this purpose must be such that the Permittee is able to analyze for the presence of the tracer in aquifer fluid samples using field testing methods. The tracer must also be included as an analyte for laboratory testing of formation fluids to verify that no drilling fluid residual is present in the formation fluid samples. In the event that the dye dissipates in the drilling mud or formation fluid to the extent that it is not detectable during sampling, stabilized values of pH and conductivity during three successive casing volumes may be used to establish the presence of native formation fluids in accordance with Part II, Section D.2.d.v.
- b. Before aquifer sample collection, each aquifer must be isolated within the well or wellbore to prevent inflow of groundwater from other aquifers.

### **Reason for change:**

In response to a comment from Powertech, Section D.2.a was revised to allow the use of stabilized values of pH and conductivity in the event that sufficient dye for detection may not be maintained in the drilling mud. The term "drill hole" in Section D.2.b was replaced with "well or wellbore" to clarify that the provision applies to both open-hole and cased-hole sampling.

## **12. Part II, Sections D.2.c and d (formerly D.2.c through D.2.g)**

### **Draft language:**

- #### **2. Aquifer Fluid Sampling Requirements**
- (. . .)

- c. Open-hole Samples: For each isolated injection interval specified in Table 6, potentiometric surface elevations will be allowed to stabilize for 30 minutes. Fluid samples shall then be collected.
- d. Open-hole Samples: A minimum of two fluid samples from each injection interval specified in Table 6 shall be collected. The second sample shall be collected after one drill stem volume of groundwater has been removed after the collection of the first sample.
- e. Open-hole Samples: The two fluid samples from each injection interval specified in Table 6 shall be analyzed for TDS, Specific Gravity, pH, and Conductivity using the analytical methods shown in Table 8. Equivalent analytical methods may be used after prior approval by the Director. Analytical results shall be reported in the units listed in Table 8.
- f. Open-hole Samples: One drill stem volume of groundwater shall be removed for the collection of each sample.<sup>4</sup>
- g. Cased-hole Samples:
  - \*Potentiometric surface data shall be determined for each perforated interval
  - \*Swab sampling should take place prior to any formation stimulation or any other procedure where fluids may enter the formation and contaminate the naturally occurring formation water
  - \*The sampling procedure should follow immediately after perforating an interval in order to prevent wellbore fluids from contaminating the naturally occurring injection formation water.
  - \*From each tubing volume recovered, measure the time, volume of fluid recovered, pH, and conductivity
  - \*When fluorescent dye is no longer detectable and pH and conductivity have stabilized during three successive tubing volumes, collect two representative sample (one each, from two successive swab runs) for complete water analysis, measuring for each of the parameters and methods listed in Table 8.

**Final language:**

2. Aquifer Fluid Sampling Requirements

- c. If open-hole samples are collected:
  - i. For each isolated injection zone specified in Table 6, potentiometric surface elevations will be allowed to stabilize for 30 minutes. Fluid samples may then be collected.
  - ii. A minimum of two fluid samples from each injection zone specified in Table 6 must be collected. The second sample must be collected after one drill stem volume of groundwater has been removed after the collection of the first sample.
  - iii. The two fluid samples from each injection zone specified in Table 6 must be analyzed for TDS, Specific Gravity, pH, and Conductivity using the analytical methods shown in Table 8. Equivalent analytical methods may be used after prior approval by the Director. Analytical results must be reported in the units listed in Table 8.
  - iv. One drill stem volume of groundwater must be removed for the collection of each sample.<sup>4</sup>
- d. Cased-hole Samples:
  - i. Potentiometric surface data must be determined for each perforated zone.

- ii. Swab sampling should take place prior to any formation stimulation or any other procedure where fluids may enter the formation and contaminate the naturally occurring formation water.
- iii. The sampling procedure should follow immediately after perforating a zone in order to prevent wellbore fluids from contaminating the naturally occurring injection formation water.
- iv. From each tubing volume recovered, measure the time, volume of fluid recovered, pH, and conductivity.
- v. When fluorescent dye is no longer detectable and pH and conductivity have stabilized (0.1 pH units and +/- 3%  $\mu\text{mhos/cm}$ , respectively) during three successive tubing volumes, collect two representative sample (one each, from two successive swab runs) for complete water analysis, measuring for each of the parameters and methods listed in Table 8.
- vi. Except as may be required by the analytical method(s) shown in Table 8, samples must be analyzed for dissolved fractions.
- vii. Equivalent analytical methods or total recoverable analysis may be used after prior approval by the Director.

**Reason for change:**

Requirements for discretionary open-hole sampling (see Change #10 to the Class V Permit above) and cased-hole sampling have been reorganized for clarity under separate sections (D.2.c and D.2.d, respectively). In response to Powertech’s request to remove Table 14, which listed stabilization criteria that no longer apply (see Change #24 to the Class V Permit below), stabilization criteria have been added to updated Section D.2.d.v to clarify when conditions are considered stabilized. Also in response to Powertech’s comments, new provisions have been added to clarify that, except as may be required by the specified analytical method, samples must be analyzed for dissolved fractions (D.2.d.vi) and that equivalent analytical methods or total recoverable analysis may be used after prior approval by the Director (D.2.d.vii).

**13. Part II, Section D.2, Table 8. List of Analytes, Approved Analytical Methods and Reporting Units for Aquifer Fluid Testing**

**Draft language:**

**Table 8. List of Analytes, Approved Analytical Methods and Reporting Units for Aquifer Fluid Testing**

Analytes	Analytical Methods	Reporting Units
1. Total Alkalinity	EPA 310.1, 310.2	mg/L
2. Arsenic	200.7, 200.8, 200.9	mg/L
3. Barium	200.7, 200.8	mg/L
4. Bicarbonate	EPA 310.1	mg/L and milliequivalents
5. Cadmium	200.7, 200.8, 200.9	mg/L
6. Calcium	EPA 6010 B, 215.1, 215.2, 200.5, 200.7	mg/L and milliequivalents
7. Carbonate	EPA 310.1, 310.2	mg/L and milliequivalents
8. Chloride	EPA 300.0, 300.1, 325.1, 325.2	mg/L and milliequivalents
9. Chromium	200.7, 200.8, 200.9	mg/L
10. Conductivity	EPA 120.1	$\mu\text{mhos}$ at 25°C
11. Fluoride	EPA 300.0, 300.1	mg/L and milliequivalents

12. Lead	200.8, 200.9	mg/L
13. Lead-210	E905.0 Mod.	pCi/L
14. Magnesium	EPA 200.5, 200.7, 242.1	mg/L and milliequivalents
15. Mercury	245.1, 245.2, 200.8	mg/L
16. pH	EPA 150.1	pH units
17. Potassium	EPA 200.7, EPA 258.1	mg/L and milliequivalents
18. Radium-226	EPA 903.1	pCi/L
19. Radium-228	EPA SW-846 9320	pCi/L
20. Selenium	200.8, 200.9	mg/L
21. Silver	200.7, 200.8, 200.9	mg/L
22. Sodium	EPA 6010 B, 200.5, 200.7, 273.1	mg/L and milliequivalents
23. Specific Gravity	ASTM D1429-13, SM 2710F	Ratio to density of water
24. Strontium	EPA 200.7, 200.8, 200.9	mg/L or µg/l
25. Sulfate	EPA 300.0, 300.1	mg/L and milliequivalents
26. Thorium -230	ASTM D3972-90	pCi/L
27. TDS	EPA 160.1	mg/L
28. Drilling Fluid Tracer		
29. Uranium (Total)	EP200.8	mg/L or µg/l
30. Uranium (Natural)	ASTM D3972-90	pCi/L

**Final language:**

**Table 8. List of Analytes, Approved Analytical Methods and Reporting Units for Aquifer Fluid Testing**

Analytes	Analytical Methods	Reporting Units
1. Total Alkalinity (as CaCO <sub>3</sub> )	A2320B	mg/L
2. Arsenic	E200.8	mg/L
3. Barium	E200.8	mg/L
4. Bicarbonate Alkalinity (as CaCO <sub>3</sub> )	A2320B (as HCO <sub>3</sub> )	mg/L
5. Cadmium	E200.8	mg/L
6. Calcium	E200.7	mg/L
7. Carbonate Alkalinity (as CaCO <sub>3</sub> )	A2320B	mg/L
8. Chloride	A4500-Cl B; E300.0	mg/L
9. Chromium	E200.8	mg/L
10. Specific Conductance	A2510B or E120.1	µmhos/cm at 25°C
11. Fluoride	E300.0	mg/L
12. Lead	E200.8	mg/L
13. Lead-210	E905.0 Mod.	pCi/L
14. Magnesium	E200.7	mg/L
15. Mercury	E200.8	mg/L
16. pH	A4500-H B	pH units
17. Potassium	E200.7	mg/L

18. Radium-226	E903.0	pCi/L
19. Radium-228	E904.0	pCi/L
20. Selenium	E200.8, A3114 B	mg/L
21. Silver	E200.8	mg/L
22. Sodium	E200.7	mg/L
23. Specific Gravity	ASTM D1429-13, SM 2710F	Ratio to density of water
24. Strontium	E200.8	mg/L
25. Sulfate	A4500-SO <sub>4</sub> E; E300.0	mg/L
26. Thorium -230	ASTM D3972-90	pCi/L
27. TDS	A2540C	mg/L
28. Drilling Fluid Tracer		
29. Uranium	E200.7, E200.8	mg/L
30. Uranium (Natural)	ASTM D3972-90	pCi/L

**Reason for change:**

In response to Powertech’s request, analytical methods were changed to be consistent with those presented in Table 8 of the Dewey Burdock Class III Area Permit and provide consistency for data collected across the project.

**14. Part II, Sections E.3.b.i and F.2.a**

**Draft language:**

E.3.b.i. After the testing of the Madison aquifer has provided the information on the potentiometric surface and other parameters required, the Permittee shall generate a drawdown model of the change in the potentiometric surface of the Madison aquifer that can be expected to result from **12 years** of pumping the Madison aquifer at each of the Madison water supply wells.

F.2.a. For each injection well, the Permittee shall calculate the injection zone formation pressures resulting from **12 years** of injection activity at the injection rate needed to dispose of the maximum anticipated volume of treated ISR waste fluids versus distance away from each injection well. Cumulative effects of injection from multiple wells shall be considered as applicable.

**Final language:**

E.3.b.i. After the testing of the Madison aquifer has provided the information on the potentiometric surface and other parameters required, the Permittee must generate a drawdown model of the change in the potentiometric surface of the Madison aquifer that can be expected to result from **10 years** of pumping the Madison aquifer at each of the Madison water supply wells.

F.2.a. For each injection well, the Permittee must calculate the injection zone formation pressures resulting from **10 years** of injection activity at the injection rate needed to dispose of the maximum anticipated volume of treated ISR waste fluids versus distance away from each injection well. Cumulative effects of injection from multiple wells must be considered as applicable.

**F.5. Modification to Calculations for Extended Injection Activity**

If this Permit is renewed or modified for a period longer than 10 years, calculations of critical pressure rise, injection-induced pressure, and maximum injection rate must be re-evaluated for the revised period of injection, including the effects of drawdown in the Madison aquifer under Section E.3.b and additional Minnelusa injection wells under Section F.4 of this Part.

**Reason for change:**

Powertech expressed concern that since the Class V Area Permit duration is 10 years, it would be appropriate to model drawdown in the Madison aquifer for 10 years rather than 12 years. EPA agrees that calculations based on a period of 10 years is appropriate for the Class V Area Permit because the permit will be issued for a period of 10 years. A new provision was added (F.5) that requires calculations to be re-evaluated for the revised period of injection if the permit is renewed or modified for a period longer than 10 years.

For consistency with Sections E.3.b.i and F.2.a, references to calculations based on 12 years also have been changed to 10 years in Part II, Sections A.1.e, D.1 (Table 7), and F.3.a.

**15. Part II, Section J.3, Table 10. Formation Testing Involving Injection**

**Draft language:**

TYPE OF TEST	PURPOSE	DUE DATE
Step Rate Test	Initial test to determine site specific fracture gradient and fracture pressure to use for calculating MAIP permit limit for each well. Injection pressures shall be measured at the surface and bottom hole to determine friction loss for each well.	After receiving Limited Authorization to Inject for testing purposes
Initial Radioactive Tracer Survey	Baseline assessment of Part II Mechanical Integrity, and injectivity profile information.	After receiving Limited Authorization to Inject for testing purposes and MAIP has been determined from the Step Rate Test, but prior to receiving Authorization to inject

**Final language:**

TYPE OF TEST	PURPOSE	DUE DATE
Step Rate Test	Initial test to determine site specific fracture gradient and fracture pressure to use for calculating MAIP permit limit for each well. Injection pressures must be measured at the surface and bottom hole to determine friction loss for each well.	Prior to receiving Authorization to Inject
Initial Temperature or Radioactive Tracer Survey	Baseline assessment of Part II Mechanical Integrity, and injectivity profile information.	After MAIP has been determined from the Step Rate Test, but prior to receiving Authorization to inject

**Reason for change:** Powertech expressed concern that few vendors run RAT logs, and it may be difficult for those vendors to get a license to bring RAT tools into South Dakota. Therefore, they requested that temperature logs should also be considered. EPA agrees that a temperature survey or a radioactive tracer survey can be used effectively to demonstrate external (Part II) mechanical integrity in conjunction with a cement bond log. Therefore, a provision was added to indicate that either a temperature survey or a radioactive tracer survey may be used to assess baseline external Mechanical Integrity.

The following sections also were updated to indicate that either a temperature survey or a radioactive tracer survey may be used: Part II, Sections I.1.i, J.5, J.5.a, and K.1  
Part IV, Section C.2.c

As shown in Change #6 to the Class V Permit, a new provision was added at Part II, Section A.10 indicating that “Results of a *temperature survey or radioactive tracer survey* for each injection well to establish a baseline assessment of Part II Mechanical Integrity and provide injectivity profile information.”

**16. Part III, Sections C.2 and L.2**

**Draft language:**

C.2. After initial well construction is complete, any subsequent changes in well construction will require a major modification of this Area Permit according to 40 CFR § 144.39 and § 124.5.

L.2. Prior to beginning any addition or physical alteration to an injection well’s construction or injection formation, the Permittee shall give advance notice to the Director. Any modification to well construction that is different from the approved well construction plan is allowed only as a major modification of this Area Permit according to 40 CFR § 144.39 and § 124.5.

**Final language:**

C.2. After initial well construction is complete, any subsequent changes in well construction that are different from approved specifications described under Part III of this Area Permit will require a modification in accordance with 40 CFR § 144.39, § 144.41, and § 124.5.

L.2. Prior to beginning any addition or physical alteration to an injection well's construction or injection formation, the Permittee must give advance notice to the Director. Any modification to well construction that is different from the approved specifications described under Part III of this Area Permit will require a modification of this Area Permit in accordance with 40 CFR § 144.39, § 144.41, and § 124.5.

**Reason for change:**

EPA received comments from Powertech indicating some confusion about permit modifications related to well construction. EPA removed the reference to a major permit modification related to changes in well construction. In order to clear up the confusion, EPA cites directly to the UIC regulations to affirm that modifications of the permit will be done in accordance with the UIC regulations. Therefore, Sections C.2 and L.2 were revised to clarify that a change to the condition would require a modification in accordance with these regulations.

**17. Part III, Section D.5 and 6 (formerly D.5)**

**Draft Permit:**

5. A float shoe shall be used with a float collar one or two joints up from the bottom of the casing and centralizers shall be placed at a minimum of one on every fifth casing joint.

**Final Permit:**

5. A float shoe may be used with a float collar one or two joints up from the bottom of the casing as field conditions dictate.
6. Centralizers must be placed at a minimum of one on every fifth casing joint.

**Reason for change:**

UIC regulations do not specify use of a float shoe, so EPA has reworded this requirement to provide flexibility to the Permittee to use a float shoe and collar as field conditions dictate. (See Response #165). UIC regulations specific to the State of South Dakota at 40 CFR § 147.2104(c), state the owner or operator of a newly drilled well shall install centralizers as directed by the Regional Administrator. EPA has determined that placing centralizers at a minimum of every fifth casing joint is a reasonable requirement, so the requirement for centralizers was not removed. To improve clarity, the centralizer requirement was made as a separate provision.

**18. Part III, Section E.3 and Part IV, Section F.3**

**Draft language:**

III.E.3. None

IV.F.3. Additional injection perforations may be added once the following requirements are met:

- a. The new perforations remain within the approved injection zone,
- b. The top perforation is no higher than the approved top of the injection zone



- c. The Permittee has received approval from the Director as a major modification of this Permit in accordance with Part III, Section C.2 of this Permit; and
- d. The Director approves the addition of perforations as a major modification of this Area Permit according to 40 CFR § 144.39 and § 124.5.
- e. After the addition of perforations, the Permittee shall follow the requirements for well Workovers and Alterations under Part III, Section L.

**Final language:**

III.E.3. Additional perforations may be added to an approved injection zone after initial construction is complete in accordance with Part IV, Section F.3.

IV.F.3. Additional injection perforations may be added once the following requirements are met:

- a. The Permittee provides notice to the Director in accordance with Part III, Section L for well Workovers and Alterations. The Permittee must also follow the requirements for the Injection Pressure Limit found in Part IV Section H, which may result in a change to the permitted MAIP.
- b. The new perforations must remain within the approved injection zone,
- c. The top perforation is no higher than the approved top of the injection zone,
- d. Fracture gradient data submitted is representative of the portion of the injection zone to be perforated, and
- e. The Permittee has received approval from the Director for the perforations.

4. After the addition of perforations, the Permittee must follow the requirements for well Workovers and Alterations under Part III, Section L.

**Reason for change:**

References to major modifications with respect to adding perforations (Draft Permit Sections F.3.c and F.3.d) were removed following consideration of concerns about this. EPA added a provision at Part III, Section E.3 to clarify that perforations may be added to an approved injection zone as part of the approved well construction standards. As such, there is no need to modify the permit when appropriate perforations are made. New provisions were added for the Permittee to notify the Director and follow requirements for Injection Pressure Limits (updated Section F.3.a) and submit representative fracture gradient data (updated Section F.3.d) to help ensure USDWs are protected. Section F.3.e was restructured as Section F.4 to reflect the fact that it applies after the addition of perforations, rather than a condition to be met prior to adding them.

**19. Part III, Sections J, J.1, K.2, and K.3**

**Draft language:**

J. Requirements for Adding Injection Wells DW No. 2 and DW No. 4 to this Area Permit

- 1. The Permittee shall not construct wells DW No. 2 and DW No. 4 under this Area Permit until Construction has been approved in accordance with the procedures under this Section.

K. Postponement of Construction

2. In order to obtain authorization for construction and operation of wells DW No. 2 and DW No. 4, the Permittee shall follow the permit requirements under Part II of this Area Permit.
3. If authorization for DW No. 2 and DW No. 4 is added to this Area Permit, there is no requirement for the Permittee to commence construction of the well within one year of authorization of the additional well(s).

**Final language:**

J. Requirements for Adding Injection Wells DW No. 2, DW No. 3, and DW No. 4 to this Area Permit

1. The Permittee must not construct wells DW No. 2, DW No. 3, and DW No. 4 under this Area Permit until Construction has been approved in accordance with the procedures under this Section.

K. Postponement of Construction

2. In order to obtain authorization for construction and operation of wells DW No. 2, DW No. 3, and DW No. 4, the Permittee must follow the permit requirements under Part II of this Area Permit.
3. If authorization for DW No. 2, DW No. 3, and DW No. 4 is added to this Area Permit, there is no requirement for the Permittee to commence construction of the well within one year of authorization of the additional well(s).

**Reason for change:**

As discussed under Change #5 to the Class V Permit, specifications for injection well DW No. 3 were removed from the Class V Area Permit because demonstration of financial responsibility for this well was not presented by the Permittee. To be consistent with this change, requirements for adding DW No. 3 to the Permit and postponement of its construction were added.

**20. Part IV, Section K.1**

**Draft language:**

1. Injection fluid is limited to waste fluids from the ISR process generated by the Dewey-Burdock Project. These waste fluids include groundwater produced from well construction, laboratory waste fluids, well field production bleed and concentrated brine generated from the reverse osmosis treatment of groundwater produced from the well field during groundwater restoration. The groundwater pumped from any portion of the Inyan Kara aquifers for the purpose of remediating an excursion is also approved for injection into the Class V injection wells.

**Final language:**

1. Injection fluid is limited to waste fluids from the ISR process generated by the Dewey-Burdock Project. These waste fluids include groundwater produced from well construction, laboratory waste fluids, well field production bleed, concentrated brine generated from the reverse osmosis treatment of groundwater produced from the well field during groundwater restoration, *restoration bleed not processed by reverse osmosis, yellowcake*

*wash water, bleed from effluent and precipitation circuits, sumps, membrane cleaning solutions, groundwater sweep solutions, and plant washdown water.* The groundwater pumped from any portion of the Inyan Kara aquifers for the purpose of remediating an excursion is also approved for injection into the Class V injection wells.

**Reason for change:**

Powertech expressed concern that there are several waste streams identified in the Waste Analysis Plan included with the permit application that were not included in the approved injectate list in the draft permit. While the draft permit did not specifically list “restoration bleed not processed by reverse osmosis, yellowcake wash water, bleed from effluent and precipitation circuits, sumps, membrane cleaning solutions, groundwater sweep solutions, and plant washdown water,” these waste streams fall into the category of “waste fluids from the ISR process generated by the Dewey Burdock Project” described under Part IV, Section K.1 of the draft permit. Therefore, EPA updated the Permit to clarify that these waste streams are also considered “waste fluids from the ISR process generated by the Dewey-Burdock Project.”

**21. Part V, Sections B and B.1**

**Draft language:**

B. Seismicity

The Permittee shall subscribe to this service and check daily for notification emails from the service. The Permittee shall notify the Director within twenty-four (24) hours of any seismic event measuring 4.0 magnitude (MMI scale) or greater reported within two miles of the permit.

1. If any seismic event of magnitude 4.0 (MMI scale) or greater is reported within two miles of the permit boundary, the Permittee shall immediately cease injection.

**Final language:**

B. Seismicity

The Permittee must subscribe to this service and check daily for notification emails from the service. The Permittee must notify the Director within twenty-four (24) hours of any seismic event measuring 4.5 magnitude (MMI scale) or greater reported within two miles of the permit.

1. If any seismic event of magnitude 4.5 (MMI scale) or greater is reported within two miles of the permit boundary, the Permittee must immediately cease injection.

**Reason for change:**

In response to Powertech’s request that the 4.0 magnitude requirement be changed to a 4.5 magnitude, EPA re-evaluated the criterion for notifying the Director within twenty-four hours of a seismic event and determined that earthquake magnitudes of 4.0 and 4.5 both generally are classified as “minor to light” (<https://www.usgs.gov/media/images/eq-magnitude-energy-release-and-shaking-intensity-5>) and that the Dewey-Burdock site is in an area of historically low seismic potential. Therefore, changing the notification criterion from 4.0 to 4.5 magnitude still is protective of USDWs.

**22. Part V, Section C.6.c and Table 13**

**Draft language:**

c. External Mechanical Integrity

The Permittee shall conduct the following external mechanical integrity tests listed in Table 13 to assess the ability of the cement behind the long string casing to prevent movement of injected fluids out of the approved injection formations.

Table 13. Ongoing External Mechanical Integrity Testing Methods

Test Type	Purpose	Frequency
Temperature Survey	To assess temperature above the upper confining zone of the injection zone to verify that cooler injection zone fluids are not moving out of the injection zone through the cement between the outermost well casing and the borehole wall.	Within 6-12 months after beginning injection operations, and at least once every five (5) years after the last successful demonstration of external mechanical integrity.
Radioactive Tracer Survey	To search for the presence of an injected radioactive tracer in the upper confining zone of the injection zone to verify that zone fluids are not moving out of the injection zone through the cement between the outermost well casing and the borehole wall.	At least once every five (5) years concurrent with the Temperature survey as required above.

**Final language:**

c. External Mechanical Integrity

The Permittee must conduct a temperature survey or a radioactive tracer survey in accordance with Table 12 to assess the ability of the cement behind the long string casing to prevent movement of injected fluids out of the approved injection formations.

**Reason for change:**

As explained under Change # 15 of the Class V Permit, the Class V Area Permit was revised to indicate that either a temperature survey or a radioactive tracer survey may be used to assess baseline external mechanical integrity. To be consistent with this change, the separate specifications for these methods were combined under Part V, Section C.6.c, and Table 13 was deleted because it was no longer needed.

**23. Part V, Section D.1.c and Table 14 (formerly Table 16)**

**Draft language:**

c. The analytical methods included in Table 16 shall be used for injectate sample analysis.

Equivalent methods may be used after prior approval by the Director.

**Table 16. Analytes to Monitor in Injectate, Reporting Units, Permit Limits and Analytical Methods**

Analyte	Reporting Units	Permit Limit	Analytical Methods
Arsenic	mg/L	5.0	200.7, 200.8, 200.9
Barium	mg/L	100.0	200.7, 200.8
Cadmium	mg/L	1.0	200.7, 200.8, 200.9
Chromium	mg/L	5.0	200.7, 200.8, 200.9
Corrosivity	pH units	>2 and <12.5	SW-846 1110,9045
Lead	mg/L	5.0	200.8, 200.9
Lead-210	pCi/L	10	E905.0 Mod.
Mercury	mg/L	0.2	245.1, 245.2, 200.8
Polonium-210	pCi/L	40	RMO-3008
Radium (Total)	pCi/L	60	E903.0/E904.0
Radium-228	pCi/L	60	EPA SW-846 9320
Specific Gravity	Ratio to density of water	1.0113	ASTM D1429-13, SM 2710F
Selenium	mg/L	1.0	200.8, 200.9
Silver	mg/L	5.0	200.7, 200.8, 200.9
Sulfate	mg/L	None	EPA 300.0
TDS	mg/L	None	EPA 160.1
TSS	mg/L	None	EPA 160.2
Thorium-230	pCi/L	100 pCi/L	ATSM D3972-90M
Uranium (Total)	mg/L or ug/L	None	200.8
Uranium (Natural)	pCi/L	300 pCi/L	ATSM D3972-90M

**Final language:**

- c. The analytical methods included in Table 14 must be used for injectate sample analysis. *Except as may be required by the analytical method(s) shown in Table 14, injectate samples must be analyzed for dissolved fractions.* Equivalent methods or total recoverable analysis may be used after prior approval by the Director.

**Table 14. Analytes to Monitor in Injectate, Reporting Units, Permit Limits and Analytical Methods**

Analyte	Reporting Units	Permit Limit <sup>1</sup>	Analytical Methods
Arsenic	mg/L	5.0	E200.8
Barium	mg/L	100.0	E200.8
Cadmium	mg/L	1.0	E200.8
Chromium	mg/L	5.0	E200.8
pH	pH units	>2 and <12.5	A4500-H B
Lead	mg/L	5.0	200.8
Lead-210	pCi/L	10	E905.0 Mod.
Mercury	mg/L	0.2	200.8
Polonium-210	pCi/L	40	RMO-3008
Radium (Total)	pCi/L	60	E903.0/E904.0
Radium-228	pCi/L	60	E904.0
Specific Gravity	Ratio to density of water	1.0113	ASTM D1429-13, SM 2710F
Selenium	mg/L	1.0	E200.8, A3114 B

Silver	mg/L	5.0	E200.8
Sulfate	mg/L	None	A4500-SO4 E; E300.0
TDS	mg/L	None	A2540C
TSS	mg/L	None	EPA 160.2
Thorium-230	pCi/L	100 pCi/L	ATSM D3972-90M
Uranium	mg/L	None	E200.7, E200.8
Uranium (Natural)	pCi/L	300 pCi/L	ATSM D3972-90M

<sup>1</sup> Permit limits for metals and radionuclides are for dissolved fractions.

**Reason for change:**

Because Tables 13 and 14 in the Draft Permit were deleted (see Changes #22 and 24 of the Class V Permit), Table 16 in the Draft Permit has been updated to Table 14 in the Final Permit. In response to comments made by Powertech, a new provision was added to clarify that, except as may be required by the specified analytical method(s) shown in Final Table 14, samples must be analyzed for dissolved fractions. Analytical methods were changed to be consistent with revised Table 8 of the Class V Area Permit as well as Table 8 of the Dewey Burdock Class III Area Permit. A footnote was added to Final Table 14 to indicate that permit limits for metals and radionuclides are for dissolved fractions.

**24. Part V, Sections D.1.f and g (formerly D.1.e, D.1.f, D.1.h, and D.1.i) and Table 14**

**Draft language:**

- e. Injectate samples shall be collected at a location between the last treatment process and the injection wellhead.
- f. Injection pressure, annulus pressure, injection rate, and cumulative injected volumes shall be observed
- h. Fluid volumes are to be measured in standard oilfield barrels (bbl).
- i. Fluid rates are to be measured in barrels per day (bbl/day).

**Table 14. Field Parameters to be Monitored and Stabilization Criteria to Meet before Sample Collection**

Parameter	Stabilization Criteria
pH	± 0.1 pH units
Specific conductance	± 3% µS/cm
Oxidation-reduction potential	± 10 millivolts
Turbidity	± 10 % NTUs when turbidity is greater than 10 NTUs
Dissolved oxygen	± 0.3 milligrams per liter

**Final language:**

- f. Fluid volumes are to be measured in standard oilfield barrels (bbl) or gallons (gal).
- g. Fluid rates are to be measured in barrels per day (bbl/day) or gallons per minute (gpm).

**Reason for change:**

Sections D.1.e and D.1.f were removed because they were editorial errors that repeated information already contained in Sections D.1.b and D.1.d, respectively. In response to a request

from Powertech, Sections D.1.h and D.1.i were revised to include measurement units of gallons and gallons per minute, respectively, to provide flexibility for measuring fluid volumes and rates.

Draft Permit Table 14 (Field Parameters to be Monitored and Stabilization Criteria to Meet before Sample Collection) was removed at Powertech’s request because it is not referenced in the permit and is no longer needed. Stabilization criteria from Table 14 for pH and conductivity were added to the text of updated Part II, Section D.2.d.v (see Change #12 to the Class V Permit). Oxidation-reduction potential, turbidity, and dissolved oxygen were not added to the stabilization parameters in this section so that it is consistent with requirements of Part II, Sections D.2.e and D.2.g of the 2019 Draft Permit, which did not include these parameters.

**25. Part V, Section D.3, Table 15 (formerly Table17). Monitoring, Recording and Reporting Requirements for Well Operating Parameters.**

**Draft language:**

Table 17. Monitoring, Recording and Reporting Requirements for Well Operating Parameters

<b>A. CONTINUOUS MONITORING</b>	
MONITOR	Injection Rate (bbl/day)
	Cumulative Injected Volume (bbl/day)
	Seismic events within a fifty (50) mile radius of the Area Permit boundary, gathered from USGS Earthquake Hazard Program website.
RECORD	Monthly for Cumulative Injected Volume Daily for other parameters Seismic events greater than or equal to 2.0 (MMI Scale) within fifty (50) miles of the project Boundary.
<b>D. MONTHLY MONITORING</b>	
	Maximum, minimum and average values for Daily Injection Rate (bbl/day)
	Injected volume for that month (bbls)
	Cumulative volume of injectate for that month (bbls)
<b>F. QUARTERLY MONITORING</b>	
	Monthly average, maximum, and minimum values for Daily Injection Rate (bbl/day)
	Injected volume for each month during the quarter (bbls)
	Cumulative volume injected since the well began injection operations (bbls)
	Summary of monthly reviews of seismic events greater than or equal to 2.0 (MMI Scale) within a fifty (50) mile radius of the Area Permit boundary.

**Final language:**

Table 15. Monitoring, Recording and Reporting Requirements for Well Operating Parameters

<b>A. CONTINUOUS MONITORING</b>	
MONITOR	Injection Rate (bbl/day or gpm)
	Cumulative Injected Volume (bbl or gal)
	Seismic events greater than or equal to 2.0 (MMI Scale) within a fifty (50) mile radius of the Area Permit boundary, gathered from USGS Earthquake Hazard Program website.

RECORD	Monthly for Cumulative Injected Volume Daily for other parameters Seismic events greater than or equal to 2.0 (MMI Scale) within fifty (50) miles of the project Boundary.
<b>D. MONTHLY MONITORING</b>	
	Maximum, minimum and average values for Daily Injection Rate (bbl/day or gpm)
	Injected volume for that month (bbl or gal)
	Cumulative volume of injectate for that month (bbl or gal)
<b>F. QUARTERLY MONITORING</b>	
	Monthly average, maximum, and minimum values for Daily Injection Rate (bbl/day or gpm)
	Injected volume for each month during the quarter (bbl or gal)
	Cumulative volume injected since the well began injection operations (bbl or gal)
	Summary of monthly reviews of seismic events greater than or equal to 2.0 (MMI Scale) within a fifty (50) mile radius of the Area Permit boundary.

**Reason for change:**

Powertech expressed concern that because low-frequency seismic events (e.g., <2.0 magnitude [MMI scale]) can occur regularly, the reference to “any” seismic event could preclude operations entirely for many days. To clarify EPA’s expectations and to be consistent with recording requirements for seismic events shown in Table 17A, minimum seismic thresholds were added for continuous monitoring (Table 17A) and quarterly reporting (Table 17.F).

Units for measuring fluid volumes and rates were revised to include gallons and gallons per minute, respectively, to be consistent with changes to Part V, Sections D.1.h and D.1.i (see Change #24 to the Class V Permit). Because Tables 13 and 14 were deleted (see Changes #22 and 24 to the Class V Permit), Table 17 in the Draft Permit has been updated to Table 15 in the Final Permit.

**26. Part V, Section E.2**

**Draft language:**

- Records of the nature and composition of all injected fluids must be retained until three (3) years after the completion of any plugging and abandonment (P&A) procedures specified under 40 CFR § 144.52(a)(6) or under part 146 subpart G, as appropriate.

**Final language:**

- Records of the nature and composition of all injected fluids must be retained until three (3) years after the completion of any plugging and abandonment (P&A) procedures specified under 40 CFR § 144.52(a)(6).

**Reason for change:**

Powertech expressed uncertainty regarding why 40 CFR part 146 subpart G regulations are referenced, as those regulations refer to Class I hazardous waste injection wells, which would



not apply to this Class V Area Permit. To improve clarity concerning applicable requirements for the Class V well(s) covered by the permit, reference to part 146 subpart G, was removed.

## 27. Part V, Section G

### Draft language:

#### G. Protective Automated Monitoring and Shut-Off Devices

5. If fluid injection occurs during the period of any week and the well is being monitored remotely, annulus fluid level shall be visually monitored a minimum of once per week at the annulus fluid head tank by the use of a level indicator or a sight glass. Any additions or subtractions of fluid from the annulus tank shall be recorded for monitoring purposes and reported on a quarterly basis per permit requirements.
6. If the proposed Dewey-Burdock Class V injection wells are monitored and operated remotely, the following special conditions shall be applicable to each well. (For the purpose of this permit, remote monitoring is defined as injection into the wells when a trained operator is not present at the well site or in the monitoring control room but is still able to receive shut-down alarms and is still able to physically respond to the well controls or the wellhead within 15 minutes of a compliance alarm condition.)
  - a. Local operating system and remote monitoring system: If remote monitoring is to be used to operate the well, an automatic paging system shall be installed that is designed to alert designated on-call, off-site personnel in the event of a well alarm or shut-in. The paging system will be equipped with a back-up power supply.
  - b. Response to automatic shut-downs related to a Permit condition: Automatic shut-downs of the operating well related to Area Permit compliance limits established for well operation shall be investigated on-site by a trained operator within three (3) hours of pager notification of the occurrence.
  - c. Loss of power to the control system: In the event that a power failure beyond the capability of the back-up power supply shuts down the control system, the well shall be automatically shut-in.
  - d. Loss of dial tone: If the automatic pager cannot get a dial tone for 90 minutes, the well shall automatically be shut-in.
  - e. Restart of the well after an automatic shut-in: Restart of the well after a shut-in related to an Area Permit condition alarm (including, but not limited to, injection pressure, annulus differential pressure, loss of dial tone for more than 90 minutes or control system power failure) shall require the physical presence of the operator to verify compliance before the well can be restarted.
  - f. Restart of the well after shut downs unrelated to a Permit condition: If the well is shut-in for more than 48 hours for circumstances unrelated to Permit conditions, restart of the well shall require the physical presence of the operator.
  - g. Monthly operator inspections: If fluid injection occurs during the period of any month and the well is being monitored remotely, a trained operator shall physically visit the site to inspect the facility at a minimum frequency of not less than once per

month. This inspection shall verify the correct operation of the remote monitoring system by review of items such as, but not limited to, a comparison of the values shown on mechanical gauges with those reported by the remote operating system.

- h. Weekly operator inspections: Unless annulus pressure changes by more than 10 percent per week while the well is injecting, only one annulus fluid level per week shall be required to be observed, recorded and reported when injection takes place.
  - i. Annulus tank fluid level measurements: When the well is not actively being used for injection, one annulus tank fluid level measurement shall be taken, recorded and reported per month unless annulus fluid pressure decreases more than 10 percent per month. In such cases of increased annulus pressure change, annulus fluid level measurements shall be taken, recorded and reported twice per month.
  - j. When not in use by a trained well operator, offloading connections shall be secured and shall be locked at the valves leading to waste water tanks so that access is restricted to trained well operators.
  - k. In the event of well shut-down, it may become necessary to transport treated ISR waste fluids (injectate) by truck to an alternate Class V injection well site within the proposed Class V Area Permit area. Offloading of fluid from transports shall only occur with a trained operator physically present on site. A waste related log sheet and/or waste manifest file will be maintained documenting that a trained well operator allowed fluid to be unloaded. At a minimum, waste log entries are to include operator name, date, time, truck identification and approximate volume.
- was reorganized to clarify which requirements apply only to remote operations and which apply to both manned and unmanned operations.

**Final language:**

- G. Protective Automated Monitoring and Shut-Off Devices
- 5. If fluid injection occurs during the period of any week, annulus fluid level shall be visually monitored a minimum of once per week at the annulus fluid head tank by the use of a level indicator or a sight glass. Any additions or subtractions of fluid from the annulus tank shall be recorded for monitoring purposes and reported on a quarterly basis per permit requirements.
- 6. *Monthly operator inspections:* If fluid injection occurs during the period of any month, a trained operator must physically visit the site to inspect the facility at a minimum frequency of not less than once per month. This inspection must verify the correct operation of the remote monitoring system by review of items such as, but not limited to, a comparison of the values shown on mechanical gauges with those reported by the remote operating system.
- 7. *Weekly operator inspections:* Unless annulus pressure changes by more than 10 percent per week while the well is injecting, only one annulus fluid level per week must be required to be observed, recorded and reported when injection takes place.
- 8. *Annulus tank fluid level measurements:* When the well is not actively being used for injection, one annulus tank fluid level measurement must be taken, recorded and

reported per month unless annulus fluid pressure decreases more than 10 percent per month. In such cases of increased annulus pressure change, annulus fluid level measurements must be taken, recorded and reported twice per month.

9. When not in use by a trained well operator, offloading connections must be secured and must be locked at the valves leading to wastewater tanks so that access is restricted to trained well operators.
10. In the event of well shut down, it may become necessary to transport treated ISR waste fluids (injectate) by truck to an alternate Class V injection well site within the proposed Class V Area Permit area. Offloading of fluid from transports must only occur with a trained operator physically present on site. A waste related log sheet and/or waste manifest file will be maintained documenting that a trained well operator allowed fluid to be unloaded. At a minimum, waste log entries are to include operator name, date, time, truck identification and approximate volume.
11. If the proposed Dewey-Burdock Class V injection wells are monitored and operated remotely, the following special conditions shall be applicable to each well. (For the purpose of this permit, remote monitoring is defined as injection into the wells when a trained operator is not present at the well site or in the monitoring control room but is still able to receive shut-down alarms and is still able to physically respond to the well controls or the wellhead within 15 minutes of a compliance alarm condition.)
  - a. *Local operating system and remote monitoring system:* If remote monitoring is to be used to operate the well, an automatic paging system must be installed that is designed to alert designated on-call, off-site personnel in the event of a well alarm or shut-in. The paging system will be equipped with a back-up power supply.
  - b. *Response to automatic shut-downs related to a Permit condition:* Automatic shut-downs of the operating well related to Area Permit compliance limits established for well operation must be investigated on-site by a trained operator within three (3) hours of pager notification of the occurrence.
  - c. *Loss of power to the control system:* In the event that a power failure beyond the capability of the back-up power supply shuts down the control system, the well must be automatically shut-in.
  - d. *Loss of dial tone:* If the automatic pager cannot get a dial tone for 90 minutes, the well must automatically be shut-in.
  - e. *Restart of the well after an automatic shut-in:* Restart of the well after a shut-in related to an Area Permit condition alarm (including, but not limited to, injection pressure, annulus differential pressure, loss of dial tone for more than 90 minutes or control system power failure) shall require the physical presence of the operator to verify compliance before the well can be restarted.
  - f. *Restart of the well after shut downs unrelated to a Permit condition:* If the well is shut-in for more than 48 hours for circumstances unrelated to Permit conditions, restart of the well shall require the physical presence of the operator.

**Reason for change:**

Powertech noted that monitoring requirements in Part V, Section G.6.h through k (for remote monitoring) apply regardless of manned or remote operations and suggested moving them to Part V, Section D.4 under *Monitoring Records*. EPA does not agree that the subject monitoring

requirements should be moved to this section. However, Part V, Section G was reorganized to clarify which requirements apply only to remote operations and which apply to both manned and unmanned operations.

## **28. Part VII, Section D.11.e (formerly e and g)**

### **Draft Language:**

- e. Twenty-four hour reporting. The Permittee must report to the Director within 24 hours any noncompliance which may endanger human health or the environment, including, but not limited to:
  - i. Any monitoring or other information which indicates that any contaminant may cause endangerment to a USDW; or
  - ii. Any noncompliance with a permit condition or malfunction of the injection system which may cause fluid migration into or between USDWs.
- (. . .)
- g. In addition, a follow up written report must be provided to the Director within five (5) days of the time the Permittee becomes aware of the circumstances. The written submission must contain a description of the noncompliance and its cause, the period of noncompliance including exact dates and times, and if the noncompliance has not been corrected the anticipated time it is expected to continue; and the steps taken or planned to reduce, eliminate, and prevent recurrence of the noncompliance.

### **Final Language:**

- e. Twenty-four hour reporting. The Permittee must report to the Director any noncompliance which may endanger human health or the environment, including:
  - i. Any monitoring or other information which indicates that any contaminant may cause endangerment to a USDW; or
  - ii. Any noncompliance with a permit condition or malfunction of the injection system which may cause fluid migration into or between USDWs.In addition, a follow up written report must be provided to the Director within five (5) days of the time the Permittee becomes aware of the circumstances. The written submission must contain a description of the noncompliance and its cause, the period of noncompliance including exact dates and times, and if the noncompliance has not been corrected the anticipated time it is expected to continue; and the steps taken or planned to reduce, eliminate, and prevent recurrence of the noncompliance.

**Reason for Change:** UIC regulation 40 CFR § 144.51 Conditions applicable to all permits, (i) Reporting requirements, (6) Twenty-four hour reporting was incorrectly divided into two requirements in the Class III Area Permit, Part XII, Sections D.10.e and g. The result of this division was that it was not clear that the follow-up written report due 5 days after a 24-hour verbal report was linked to the 24-hour reporting requirement. In order to be consistent with the mandatory regulatory language from 40 CFR § 144.51, EPA corrected this error in the final permit by incorporating the language under former requirement Part XII, Section D.10.g into requirement Part XII, Section D.10.e.

## 29. Part IX, Section A.1

### Draft language:

A. The National Historic Preservation Act (NHPA) of 1966, 16 U.S.C. 470 et seq.

(. . .)

1. The Permittee shall abide by the stipulations of the Programmatic Agreement (PA) among U.S. Nuclear Regulatory Commission, U.S. Bureau of Land Management, South Dakota State Historic Preservation Office, Powertech (USA), Inc. and Advisory Council on Historic Preservation Regarding the Dewey-Burdock In-Situ Recovery Project Located in Custer and Fall River Counties South Dakota (PA) dated March 19, 2014, and the EPA addendum to the PA.

### Final language:

A. The National Historic Preservation Act (NHPA) of 1966, 16 U.S.C. 470 et seq.

(. . .)

1. The Permittee must abide by the stipulations of the Programmatic Agreement (PA) among U.S. Nuclear Regulatory Commission, U.S. Bureau of Land Management, South Dakota State Historic Preservation Office, Powertech (USA), Inc. and Advisory Council on Historic Preservation Regarding the Dewey-Burdock In-Situ Recovery Project Located in Custer and Fall River Counties South Dakota (PA) dated March 19, 2014 and adopted by EPA on November 13, 2020.

**Reason for change:** On November 13, 2020, EPA adopted the Programmatic Agreement described in the permit requirement without adding an EPA addendum and updated measure 1 accordingly.

## 30. Part IX, Section B

### Draft language:

B. The Endangered Species Act, 16 U.S.C. 1531 et seq.

Section 7 of the Act and implementing regulations (50 CFR part 402) require the EPA to ensure, in consultation with the Secretary of the Interior or Commerce, that any action authorized by EPA is not likely to jeopardize the continued existence of any endangered or threatened species or adversely affect its critical habitat.

The Permittee shall comply with the following mitigation measures:

1. If the whooping crane, the rufa red knot or the northern long-eared bat are sighted within one mile of the UIC well sites or associated facilities during construction or operation, all work within one mile of the species' location must cease, and the Permittee must contact the EPA and the USFWS immediately. In coordination with the USFWS, work may resume after the terrestrial species leave the area.
2. Any wells, equipment or buildings associated with the UIC wells authorized under the permit with a fixed location within the project area must be constructed to eliminate openings that look like a small cave or hibernacle to avoid the entrance of any northern long-eared bat.

3. In the event that construction is planned during the migratory bird nesting and breeding season, a qualified biologist must conduct pre-construction surveys for migratory birds and their nests within five days prior of the initiation of any construction activities.
4. Spills or leaks of chemicals and other pollutants at the UIC well site must be reported to the appropriate regulatory agencies. The procedures of the surface management agency must be followed to contain leaks or spills.
5. If supplemental lighting is used during construction or operation, the lights must be directed and/or sheltered to minimize the amount of light escaping the work or project site.
6. The Permittee shall install netting, use bird balls or other acceptable bird deterrent method to prevent birds and bats from accessing the ponds.
7. Tree removal activities must be conducted outside of the northern long-eared bat active season (April 1 to October 31). This will minimize impacts to northern long-eared bat pups at roosts not yet identified.
8. During the northern long-eared bat active season (April 1 to October 31), the Permittee shall use a motion-activated camera to monitor the Triangle Mine vertical ventilation shaft located at NWNW Section 35, T6S, R1E for 5 days and nights and determine if bats are entering and exiting. If no bats are observed entering or exiting the shaft, the Permittee shall investigate the shaft to determine if bats are inside the shaft. If no bats are inside the shaft, the Permittee shall cover the entrance to the shaft with finer mesh to prevent bats from entering. If bats are observed in the shaft, the Permittee shall work with South Dakota Game, Fish and Parks to evaluate methods for establishing an appropriate buffer zone around the shaft to prevent tree removal or wellfield construction activity. The buffer zone will need to take into account the fact that the shaft is only a few feet away from a road that is used by local residents and may be improved to use as an access road to the Project Site.

**Final language:**

B. The Endangered Species Act, 16 U.S.C. 1531 et seq.

Section 7(a)(2) of the ESA and its implementing regulations (50 CFR part 402) require EPA to ensure, in consultation with the Secretary of the Interior or Commerce, that any action authorized by EPA is not likely to jeopardize the continued existence of any endangered or threatened species or result in the destruction or adverse modification of the designated critical habitat of such species.

EPA incorporates the following measures in the UIC permits to avoid, minimize or mitigate any potential impacts to federally-listed species:

1. In the event that construction is planned during the whooping crane and rufa red knot migration seasons or the northern long-eared bat (NLEB) active season, within five days prior to the initiation of any construction activities, a qualified biologist must conduct pre-construction surveys for these species and training for workers to assist with the identification of all listed species during construction and operation.
  - a. Whooping crane migration seasons: migrates through South Dakota April 1 to mid-May and mid-September to mid-November.
  - b. Rufa red knot migration seasons: migrates through South Dakota mid-April to mid-May and mid-September to October 31.

- c. NLEB active season: mid-April to October 31. The critical pup season is June 1 – July 31.
2. If the whooping crane, the rufa red knot or the northern long-eared bat are sighted within one-half mile of the well sites or associated facilities during construction or operation, the Permittee must contact EPA and the FWS immediately and all construction work within one-half mile of the species' location must cease. Powertech will work with the FWS and a qualified biologist to minimize surface operation activities within one-half mile of the species' location. In coordination with the FWS, work may resume after the species leave the area. For this measure and other ESA-related matters related to this project, the Permittee should contact the FWS and EPA by phone, followed up by an e-mail. The contact points are:
    - The FWS South Dakota Field Office – (605) 224-8693, email: southdakotafieldoffice@fws.gov
    - EPA Region 8 UIC Program – (303) 312-6079, email: minter.douglas@epa.gov
  3. Any wells, equipment or buildings associated with the UIC wells authorized under the permit with a fixed location within the project area must be constructed to eliminate openings that look like a small cave or hibernacle to avoid the entrance of any northern long-eared bats.
  4. Spills or leaks of chemicals and other pollutants at the UIC well site must be reported to the appropriate regulatory agencies. The procedures of the surface management agency must be followed to contain leaks or spills.
  5. If supplemental lighting is used during construction or operation activities, as a protection measure for northern long-eared bat, the lights must be directed and/or sheltered to minimize the amount of light escaping the work or project site.
  6. The Permittee must install netting, use bird balls or other acceptable bird deterrent method to prevent birds and bats from accessing all project ponds.
  7. Tree removal activities within the project area must be conducted outside of the northern long-eared bat active season (mid-April to October 31). This will minimize impacts to the northern long-eared bat, including to NLEB pups during the critical pup season.
  8. During the northern long-eared bat active season (mid-April to October 31), the Permittee must use a motion-activated camera to monitor the Triangle Mine vertical ventilation shaft located at NWNW Section 35, T6S, R1E for 5 days and nights and determine if bats are entering and exiting. If no bats are observed entering or exiting the shaft, the Permittee must investigate the shaft to determine if bats are inside the shaft. If no bats are inside the shaft, the Permittee must cover the entrance to the shaft with finer mesh to prevent bats from entering. If bats are observed in the shaft, the Permittee must work with South Dakota Game, Fish and Parks to evaluate methods for establishing an appropriate buffer zone around the shaft to prevent tree removal or wellfield construction activity. The buffer zone will need to take into account the fact that the shaft is only a few feet away from a road that is used by local residents and may be improved to use as an access road to the Project Site.

**Reason for Change:** In 2020, EPA prepared a revised Biological Assessment in consideration of comments received during the public comment period on the draft UIC permits and aquifer exemption and based upon further research and discussions with the FWS. The updated BA analyzes the potential impacts of the EPA actions on federally-listed species and includes these revised

mitigation measures. The FWS provided written concurrence with EPA’s determination that its actions that include these measures “may affect, but are not likely to adversely affect,” the rufa red knot, northern long-eared bat and whooping crane. For additional information about changes to individual mitigations measures, see EPA's responses to these comments: #382, #383, #384, #385, #386.

**31. Part IX, Section C**

**Draft language:** None

**Final Language:**

**C. Record Keeping and Retention Requirements for Endangered Species Act Mitigation**

The Permittee must document all activities related to compliance with Part IX, Section B of this Permit. All records of such documentation must be retained and made available for inspection or upon request by the Director. The Permittee must notify the Director as to the location where the records of ESA-related activities are maintained and notify the Director if this location changes. All records must be retained until all wells have been plugged and abandoned after which the owner or operator must deliver the records to the Director or obtain written approval from the Director to discard the records.

**Reason for change:** EPA has included this new requirement to ensure adequate documentation and record retention for activities performed in compliance with the permit requirements related to the protection of federally-listed species.

**Typos and other editorial changes**

<b>Permit Section</b>	<b>Change</b>
Part I, Section A	Period added after “South Dakota”
Part II	Capitalized “i” in “Inject” in “Authorization to Inject”
Part II, Section D.3	Capitalized “i” in “Inject” in “Authorization to Inject”
Part II, Section E.3.a.i	Changed number format for A. through F. to A) through F)
Part II, Section E.3.a.iii	Changed number format for A. and B. to A) and B)
Part II, Section F.1	Deleted comma after “Unkpapa/Sundance” and after “Madison”
Part II, Section F.3.a	Changed “breech” to “breach”
Part II, Section F.3.b	Capitalized “i” in “Inject” in “Authorization to Inject”
Part II, Section I.2	Capitalized “i” in “Inject” in “Authorization to Inject”
Part II, Section I, Table 10	Capitalized “i” in “Inject” in “Authorization to Inject” in second row, third column
Part II, Section I.4.cv	Capitalized “i” in “Inject” in “Authorization to Inject”
Part II, Section J.2	Capitalized “i” in “Inject” in “Authorization to Inject” Change capital letter to lower case in part 61 subpart W
Part II, Section J.4.b	Moved “Test”) to end of previous line
Part II, Section K.1.b	Updated reference to Part II, Section J.4.b with reference to Part II, Section I.4.c
Part III, Section C.2	“According to” was replaced with “in accordance with”
Part III, Section K.1	Updated “describe in Table 17” with “described in Table 15”
Part III, Section L.2	“According to” was replaced with “in accordance with”



Part IV, Section B	Capital "P" in "part" changed to lower case in 40 CFR part 141
Part IV, Sections C.1 and C.2.d	Capitalized "i" in "Inject" in "Authorization to Inject"
Part IV, Section F.2	Capitalized "i" in "Inject" in "Authorization to Inject" in two places
Part IV, Section F.3.b	Added comma after "zone"
Part IV, Section H.3	Updated reference to Part II, Section J.4 with reference to Section I.4 Capitalized "i" in "Inject" in "Authorization to Inject"
Part IV, Section J	Capitalized "i" in "Inject" in "Authorization to Inject" in two places
Part IV, Section K.2	Updated reference to Table 16 with reference to Table 14
Part V, Sections B.3 and 4	Removed bold font from "the" where it occurs before "Director"
Part V, Section C.7.a	Changed "see Part VII, Section D.11.e" to "see also Part VII, Section D.11.e"
Part V, Section D.1.c	Updated reference to Table 16 with reference to Table 14
Part V, Section D.2.a.i	Updated references to Tables 15 and 16 with references to Tables 13 and 14
Part V, Table 15	Updated Table 15 to Table 13 and updated references to Table 16 with references to Table 14
Part V, Table 16	Updated Table 16 to Table 14
Part V, Table 17	Updated Table 17 to Table 15 and updated references to Table 16 with references to Table 14
Part V, Table 17A	Changed bbl/day to bbl for oilfield units of cumulative injected volume
Part V, Tables 17D and F	Changed bbls to bbl for oilfield units of injected and cumulative volumes
Part V, Section D.2.a.iii	Updated reference to Table 15 with reference to Table 13 and changed number format for A. through D. to A) through D)
Part V, Section D.2.b	Updated references to Table 17 with references to Table 15
Part V, Section D.3	Updated reference to Table 17 with reference to Table 15
Part V, Section F	Updated reference to Table 18 with reference to Table 16
Part V, Table 18	Updated Table 18 to Table 16
Part VII, Section D.1	Capital "S" in "Section" changed to lower case in section 1423 of the SDWA
Part VII, Section D.2.b	Changed number format for (i) and (ii) to i. and ii.
Part VII, Section D.11	Capitalized "i" in "Inject" in "Authorization to Inject" in two places
Part VII, Section D.11.c	Removed extra spaces in front of "Monitoring Reports."
Part VIII, Section A, first two dotted bullets	"40 CFR" and the "§" symbol was added in front of regulation citations to be consistent with other regulation citations.
Part VIII, Sections A.1	The "§" symbol was added to 40 CFR § 144.70 citation to be consistent with other regulation citations.
Part VIII, Sections B	Changed number format for 1, 2, and 3 to 1., 2., and 3.

## **RESPONSE TO COMMENTS**

### **Postponement of Actions**

- 1. The EPA should pause its permitting actions now until the NRC process is complete because many of the water issues are common to both the NRC and the EPA.**

Response #1:

EPA is aware of the Nuclear Regulatory Commission's licensing process and the administrative process that recently concluded. However, the NRC's action is under the Uranium Mill Tailings Radiation Control

Act (UMTRCA) while EPA's actions are under the Safe Drinking Water Act (SDWA), and they are independent from the other. While there may be some overlap in water issues, each statute serves a different purpose, and each agency must determine that the requirements in the statute it administers are met.

### **Concerns About Geology and Confinement**

- 2. A commenter asserted that the presence of artesian groundwater at the project site clearly demonstrates that there is interconnection and hydraulic communication between aquifers on site and off site. The commenter stated that artesian flow demonstrates a lack of containment at the site and poses a significant risk of unexpected, serious contamination of the Cheyenne River and its tributaries.**

Response #2:

EPA is aware of the hydrology at this site and the potential for communication between aquifers in this area. However, the Class III area permit addresses this potential concern through a number of permit requirements.

On its Artesian Water and Artesian Wells website, the United State Geologic Service (USGS) provides the following information about artesian aquifers:

Groundwater in aquifers between layers of poorly permeable rock, such as clay or shale, may be confined under pressure. If such a confined aquifer is tapped by a well, water will rise above the top of the aquifer and may even flow from the well onto the land surface. Water confined in this way is said to be under artesian pressure, and the aquifer is called an artesian aquifer.

<https://www.usgs.gov/special-topic/water-science-school/science/artesian-water-and-artesian-wells> (last visited October 9, 2020). The fact that an aquifer is artesian indicates that it is hydraulically contained within low permeability confining zones. In western South Dakota, the slope of sedimentary aquifers away from the Black Hills uplift creates a hydraulic head that increases with distance away from the aquifer's recharge area. Artesian aquifers surrounding the Black Hills uplift eventually reach a hydraulic head that allows groundwater to flow to ground surface, as observed at Cascade Springs, where Madison aquifer groundwater, and a smaller volume of Minnelusa groundwater, flow to the surface.

There are several wells within the Dewey-Burdock Project Site area that would flow to the groundwater surface, if not sealed at the wellhead. Figures 4.7 and 4.8 in the Class III Permit Application show where the potentiometric surface of the Fall River and Chilson aquifers, respectively, are above ground surface.

EPA is aware of the artesian aquifers within the project area, and the Class III Area Permit includes several requirements to prevent the type of communication that the commenter is concerned about. The Permit requires that the Permittee plug any private wells that would provide a conduit through confining zones in the wellfield areas where injection zone fluids could flow out of the injection interval into other aquifers or to the ground surface. The Class III Area Permit requires wellfield pump tests to identify areas where the confining zones are compromised by improperly plugged exploration boreholes and wells that may provide pathways through confining zones and any naturally occurring conduits, such as fractures or faults, that compromise the integrity of confining zones. These permit requirements are

designed to protect USDWs and surface water by preventing injection zone fluids from migrating out of the injection interval into USDWs or to the ground surface and impact the Cheyenne River. The commenter did not specify any reasons why these permit conditions would not adequately address the concerns raised.

- 3. A commenter stated that artesian flow allows the rapid transfer of water along the subsurface conduits through which it flows, and greatly increases the likelihood of large amounts of highly contaminated subsurface water reaching the surface and contaminating it.**

Response #3:

As stated previously, artesian groundwater is evidence of aquifer confinement where the potentiometric surface rises above the top of the geologic formation, in some cases resulting in groundwater flow at the surface if the hydraulic head is high enough. However, artesian flow is not indicative of how fast groundwater flows within the aquifer. Instead, aquifer properties such as porosity, permeability, and hydraulic conductivity influence the rate of groundwater flow in an aquifer. Furthermore, as explained in Response #2 above, the Class III Area Permit includes several conditions to prevent injection zone fluids from migrating out the injection interval. The commenter did not specify any reasons why these permit conditions would not adequately address the concerns raised.

- 4. Commenters asserted that Powertech did not adequately characterize the presence of fractures, fissures, sinkholes and breccia pipes in the project area. They claim that these features dramatically increase permeability within confinement layers. Commenters referenced reports and drillhole logs developed by the Tennessee Valley Authority and claimed that Powertech selectively included information that supported their project and did not provide a scientifically recognized analysis that can support any hydrogeological conclusion about the project area. The commenters concluded that the discussion presented demonstrates that the applicant, and EPA, have failed to provide an adequate baseline geology and hydrogeology analysis and as a result fails to adequately analyze the impacts associated with the proposed mine, particularly on groundwater resources and with respect to the applicant's ability to contain mining fluid.**

**One commenter also referenced the USGS-derived Gott map and asserted it "shows faults, fractures, and breccia pipes in the immediate area of the proposed project, and thus is far more credible testimony that the geology is highly variable in the area given the scientific evidence. At minimum, this corroboration between the Tribe's expert testimony and the extensive geological reports demonstrates EPA's failure to conduct the necessary physical surveys to confirm or deny the presence of these geological features – especially considering the applicant's pump tests proving leaky confining layers. Instead, EPA's draft permit materials rely on the applicant's assumptions, unsupported by empirical data or detailed site investigation, that somehow in a sea of geological fractures and faults surrounding the Black Hills and particularly in this area, the applicant's chosen site is free of geological irregularity that would affect fluid containment simply because there is no 'smoking gun' in the reports showing a major fault directly crossing the site."**

#### Response #4:

The UIC regulations require that EPA consider information in 40 CFR § 146.34(a) prior to issuance of a permit. This includes maps and data reasonably available from public records or otherwise known to the applicant on wells in the area of review, but it does not include a full characterization of the geology and groundwater prior to issuance of a permit. The Class III Area Permit requires a full geologic and hydrologic characterization of each wellfield before EPA will approve injection for in-situ recovery (ISR) operations in a wellfield. This process is consistent with the UIC regulations.

EPA disagrees that adequate preliminary baseline geologic and hydrogeologic analysis has not been conducted at the Dewey-Burdock project site. EPA summarized its evaluation of the geological and hydrological analysis provided in the Class III Permit Application, including the adequacy of confining zones, in Sections 3.0 and 4.0 of the Fact Sheet for the draft Class III Area Permit. Information reviewed included drillhole logs, cross sections, and pump test data in order to evaluate the confining zones for the proposed injection intervals. In addition, EPA reviewed the Tennessee Valley Authority (TVA) pump test reports and Draft Environmental Statement, which did not provide any information that contradicts the geologic and hydrologic characterization in the Class III Permit Application. EPA also reviewed geologic maps of the project area and surrounding areas and read USGS reports describing geologic and hydrologic conditions in the vicinity of the Dewey-Burdock project site.

Additionally, EPA used Regional Applied Research Effort funding from the EPA Office of Research and Development (ORD) to work cooperatively with the USGS and the EPA ORD to conduct independent analyses of groundwater and develop a reactive transport model in the Burdock Area to provide information about the fate and transport of ISR contaminants at the site. The USGS reactive transport model helped inform the permit requirements for Part IV of the Class III Area Permit for further development of the conceptual site model (CSM) and geochemical modeling of the site.

Breccia pipes - EPA specifically evaluated the potential for the presence of breccia pipes in the project area. Based on this evaluation, EPA has determined they do not exist in the project area. EPA reviewed four different published reports on this issue. Boggs and Jenkins, 1980, mentioned breccia pipes in the report on the Burdock aquifer pump test the Tennessee Valley Authority conducted at the site. Boggs and Jenkins referred to the theory described in Bowles, 1968, that recharge to the Inyan Kara aquifers may be occurring through upward movement of groundwater along solution collapse features and breccia pipes from the deeper Minnelusa and Madison aquifers. Boggs and Jenkins identified these conduit features in the Dewey Fault area and Long Mountain structural zone but did not identify any of these structures within the Dewey-Burdock Project Area. (Boggs, JM and Jenkins, AM, 1980, *Analysis of Aquifer Tests Conducted at the Proposed Burdock Uranium Mine Site, Burdock, South Dakota*, Tennessee Valley Authority Report No. WR28-1-520-109, at 3, 6), (Bowles, C.G., 1968, *Theory of uranium deposition from artesian water in the Edgemont district, southern Black Hills*, in Wulf, G.R., ed., *Black Hills area, South Dakota, Montana, Wyoming: Wyoming Geological Association, 20th Field Conference Guidebook, 1968*).

Section 4.9 of the Fact Sheet for the draft Class III Area Permit and Section 3.3.3 of the Fact Sheet for the draft Class V Area Permit discuss information presented in Naus et al. 2001 (Naus, C.A., et al., 2001, *Geochemistry of the Madison and Minnelusa Aquifers in the Black Hills Area, South Dakota*, USGS Water-Resources Investigations Report 01-4129) indicating that breccia pipes will not be found downgradient from a dissolution zone in the Minnelusa aquifer that is located 6 miles upgradient from the Dewey-

Burdock project site. Gott et al., 1974 described collapse features and breccia pipes affecting the Minnelusa Formation and in some cases the Lakota Formation in the Inyan Kara Group. The references for the occurrences of these structures indicate they occur in the Jewell Cave SW Quadrangle and the Hot Springs Quadrangle. Gott did not document any collapse features or breccia pipes inside the Dewey Burdock Project site. EPA observed the Lower Minnelusa confining zone in five oil and gas well logs ranging northeast to southeast of the Dewey-Burdock project area. One well is located in the project area. EPA analysis of available information about the Minnelusa injection interval confining zones indicates there will be adequate confinement of injection zone fluids. (See Gott, G.B., et al., 1974, *Stratigraphy of the Inyan Kara Group and Localization of Uranium Deposits, Southern Black Hills, South Dakota and Wyoming*, USGS Professional Paper 763, at 31).

Gott et al., 1974, (Id. at 45) theorized that breccia pipes were part of an upwelling “plumbing system” that was responsible for the deposition of uranium ore bodies in the Inyan Kara aquifers. This report posited that groundwater from the Madison and Minnelusa aquifer flowed upward into the Inyan Kara aquifers through the breccia pipe plumbing system which not only recharged the Inyan Kara aquifers, but also carried low concentrations of uranium as well that precipitated out upon reaching the geochemical conditions in the Inyan Kara aquifers. This theory suggests that breccia pipes would need to be present in the Dewey-Burdock Project Area based on the presence of the uranium ore deposits. While there are USGS references that support the theory that Inyan Kara aquifers are recharged by groundwater upwelling from the underlying Madison and Minnelusa aquifers, that model of uranium deposition through a breccia pipe plumbing system has been replaced by another depositional model. Hobday and Galloway, 1999, describe uranium deposits produced by surface water infiltrating downward into an aquifer at the recharge area after burial of the host aquifer recharge area by a uranium source. The current process thought to be responsible for the Dewey-Burdock ore deposits is discussed in Harshman and Adams, 1980: Tertiary age uranium-bearing volcanic-rich source rock was deposited unconformably over the Inyan Kara outcrop exposed by erosion of the Black Hills uplift. (Hobday, D.K. and Galloway, W.E., 1999, *Groundwater processes and sedimentary uranium deposits*, Hydrogeology Journal 7. 127-138; Harshman, E.N. and Adams, S.S., 1980, *Geology and Recognition Criteria for Roll-Type Uranium Deposits in Continental Sandstones*, Final Report prepared for the US Department of Energy at p. 12).

Fractures and Joints - Commenters referred to the occurrence of fractures in Project Area. These are more likely joint systems, which are commonly occurring geologic structures that are not unique to the Dewey-Burdock Project Area. Joint systems are discussed briefly in the Dewey and Burdock geologic quadrangles reports (Brobst, D.A., 1961, *Geology of the Dewey quadrangle, Wyoming South Dakota*: U.S. Geol. Survey Bull. 1063-B, at 51., Schnable, R.W., 1963, *Geology of the Burdock quadrangle, Fall River and Custer Counties, South Dakota*: U.S. Geol. Survey Bull. 1063-F, at 210). Gott et al., 1974, discusses joint systems occurring in the report study area. (Gott et al., 1974, at 29). Figure 10 in the Gott report shows the primary and secondary joint set orientations in the study area, including the Dewey-Burdock Project Area. Jointing may cause preferential flow in the directions of the primary and secondary joint sets within the injection intervals. Boggs and Jenkins noted during the TVA Burdock Area pump test the principal direction of transmissivity parallels the strike of a regional fracture-joint set. (Boggs and Jenkins, 1908, at 14-15). Wicks et al, 1999, focused on the joint patterns and orientations in the Fall River Formation surrounding the Black Hills. (Wicks, J. L., 1999, *Regional tectonics and fracture patterns in the Fall River Formation (Lower Cretaceous) around the Black Hills foreland uplift, western South*

*Dakota and northeastern Wyoming*, Geological Society, London, Special Publications, 169, 145-165). Although Boggs and Jenkins hypothesize that the hydraulic communication between the Fall River and Chilson aquifers observed during the TVA Burdock pump test tests may be partly attributable to general leakage through the primary pore space and naturally occurring joints and fractures of the Fuson shale in addition to direct connection through historic improperly plugged exploration boreholes, EPA did not find any evidence of joints in the Fuson Shale or Graneros Group shales except at outcrop areas where desiccation from exposure has caused shrinkage. The wellfield pump tests required under Part II, of the Class III Area Permit will evaluate confining zone integrity and identify preferential flow directions in the injection interval. Therefore, EPA does not have concerns about joint systems compromising integrity of confining zones at the Dewey Burdock Project Area.

EPA acknowledges that the presence of joints will cause heterogeneity in groundwater flow by creating preferential flow paths, as noted by Boggs and Jenkins in the previous paragraph. Wellfield pump test data will enable the Permittee to design the wellfield injection and production well patterns and orientations to accommodate preferential flow directions in the injection interval. EPA has added a requirement under Part II, Section H.3.e of the Class III Area Permit requiring the Permittee to characterize faults, fractures, and lithologic variability that might provide preferential flow paths or otherwise affect groundwater flow in the Injection Authorization Data Package Report. This requirement was already included under Part IV, Section A.2.a requirements for wellfield Conceptual Site Models in the second draft Class III Area Permit and is retained in the final Class III Area Permit. The addition of a similar requirement under Part II, Section H.3.e of the final Class III Area Permit emphasizes the importance of this characterization work.

#### The Dewey Fault

There is no evidence of the Dewey fault inside the project area. (Brobst, 1961, *Geology of the Dewey Quadrangle Wyoming-South Dakota*, USGS Bulletin 1063-B.) Brobst, 1961, describes the Dewey Fault in the Dewey quadrangle geologic report as the fault passing through the town of Dewey and refers to the fault located to the southeast without a name. Braddock, 1963, does not refer to more than one fault plane related to the Dewey Fault in the Geology of the Jewel Cave SW quadrangle report (Braddock, W.A., 1963, *Geology of the Jewel Cave SW quadrangle Custer County, South Dakota*, USGS Bull 1063-G). Gott, et al., 1974, includes both faults described by Brobst, 1961, in the Dewey Fault and Structural Zone. The boundaries of this structural zone are shown in Plates 2 and 4 of the Gott et al., 1974 report. The extent of the Dewey Fault and Structural Zone as defined by Gott in Plate 2 near the Dewey-Burdock Project Site is shown in Figure A. The Dewey-Burdock Project Site Boundary is superimposed on Plate 2. Although Gott shows the Dewey Fault and Structural Zone as extending into the northwestern edge of the Dewey-Burdock Project Site, there is no evidence of any fault inside the Project Area.

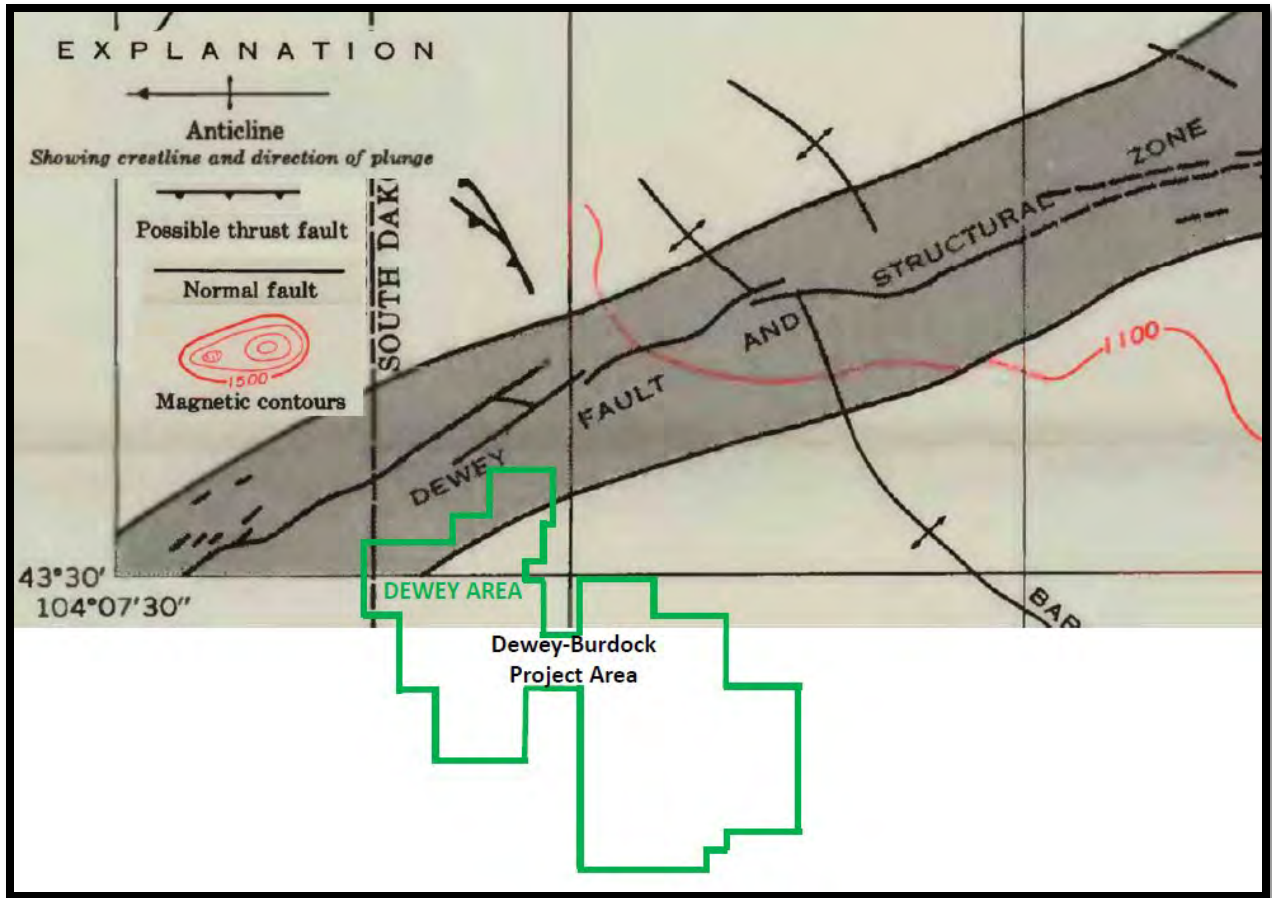

**Figure A. Gott et al., 1974, Plate 2 showing the extent of the Dewey Fault and Structural Zone with the Dewey-Burdock Project Area superimposed.**

A commenter referred to Plate 4 from Gott et al., 1974, as the Gott fault map. Powertech used Plate 4 as a base map for Plate 6.24 of the Class III Permit Application and superimposed the Dewey-Burdock Project Boundary to show where the collapse features and breccia pipes identified in Gott et al., 1974, are located relative to the Project Site. Plate 6.24 shows that none of these features are located inside the Project Area. Figure B is an excerpt from Plate 6.24. The features shown inside the project boundary are Beaver Creek and paleostreams. The linear feature in the red box inside the Dewey-Burdock Project Area is the southeast boundary of the Dewey-Fault and Structural Zone shown in Plate 2.



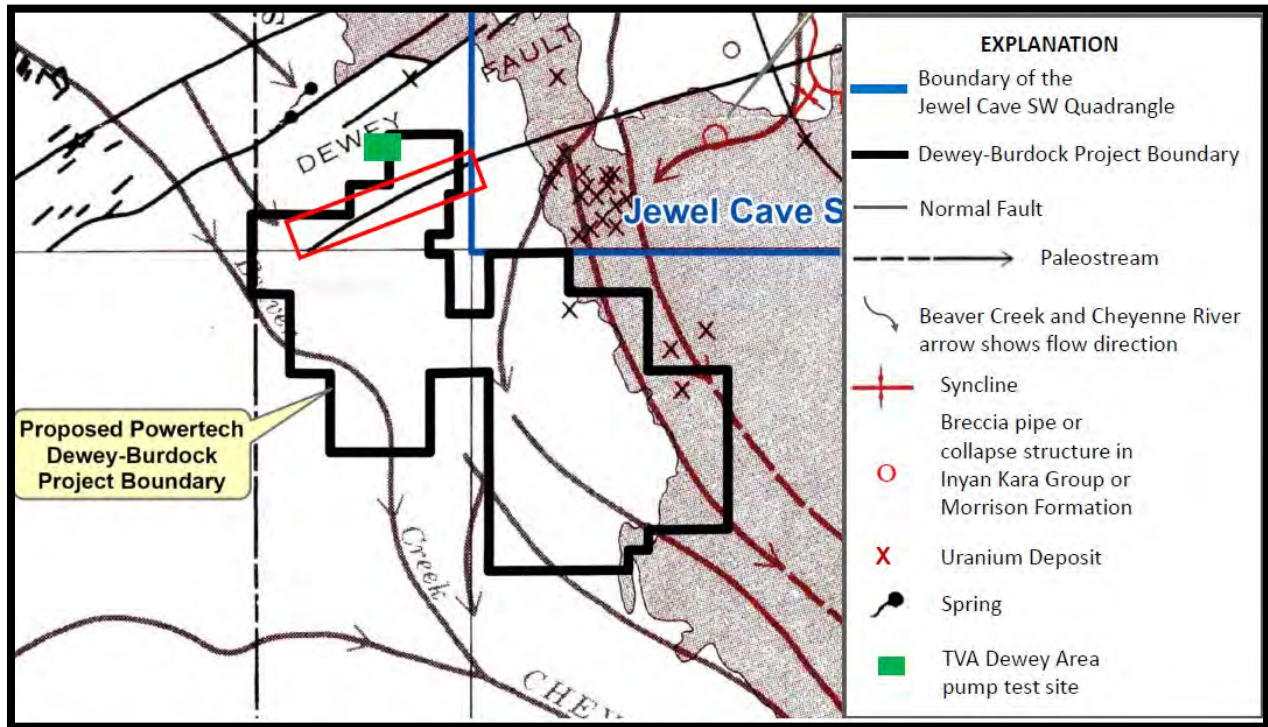
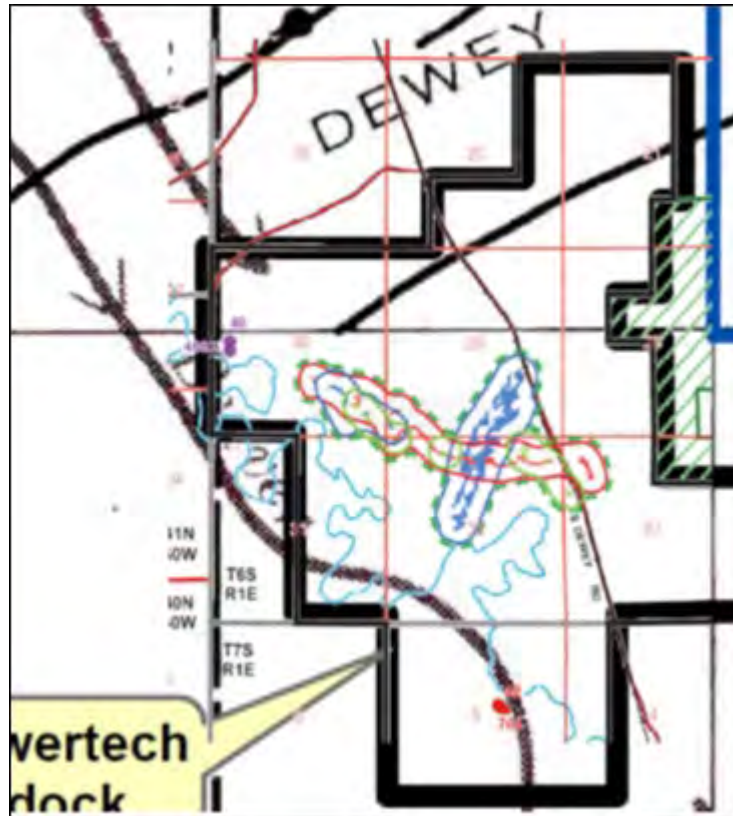

**Figure B. Excerpt from Gott et al., 2001, Plate 4 showing features inside the Dewey-Burdock Project Boundary.**

Boggs, 1983, does not identify any faults in the report on the aquifer pump test the TVA conducted in the Dewey Area. (Boggs, 1983, *Hydrogeologic Investigations at Proposed Uranium Mine Near Dewey, South Dakota*, Tennessee Valley Authority Report No. WR28-2-520-128.) According to Boggs, one of the purposes of this pump test was to determine the hydrologic impact the Dewey Fault would have on the drawdown in the Chilson Sandstone (called the Lakota in this report) during the pump test. The TVA Dewey area pump test location, shown as the green box in Figure B, was set downgradient of the southeastern fault of the Dewey Fault and Structural Zone for this reason. The red box in Figure B outlines the southeastern boundary of the Dewey Fault and Structural Zone as identified by Gott et al., 1974. If there were any faults in the Dewey-Burdock Project Area, the TVA pump test would have been located further southeast. In addition, no additional faults were mapped in the Dewey Geologic Quadrangle (Brobst, 1961) which shows the other Dewey Fault traces. Therefore, EPA concludes there are no faults related to the Dewey Fault and Structural Zone in the Dewey-Burdock Project Area.

Figure C shows that the southeastern edge of the Dewey Fault and Structural Zone does not intersect the proposed wellfields in the Dewey Area, so it is not of concern for the currently proposed for ISR operations. The fact that the Dewey Fault and Structural Zone is located upgradient of the Dewey wellfields and the inward hydraulic gradient required for each wellfield will prevent ISR injection interval fluids from migrating to the location of this zone. If Powertech proposes future wellfields in this area, correlation of drillhole data in the area would identify any offset of geologic strata caused by the presence of a fault.





**Figure C. Dewey wellfield locations relative to the possible normal fault location in the Dewey-Burdock Project Boundary.**

EPA disagrees with the commenter's statement that the features in Plate 4 demonstrate that EPA failed to conduct the necessary physical surveys to confirm or deny the presence of these geological features. Based on the discussion above regarding the features identified in Plate 4 within the Project Area, there is no need for EPA to perform a physical survey because no disruption of confining zones in the currently proposed wellfield areas is indicated by the information in Plate 4.

#### Aquifer Pump Test Data and Leaky Confining Zones

The commenters stated that because the applicant's pump tests indicate leaky confining layers, EPA needed to conduct additional physical surveys to analyze the ability to contain mining fluid and properly identify potential impacts to groundwater resources. EPA agrees that additional physical surveys, including additional wellfield pump tests, should be conducted for the reasons the commenters stated; this is already a requirement in Part II of the Class III Area Permit. Section 4.6 of the Fact Sheet for the draft Class III Area Permit discusses EPA's evaluation of potential breaches in the Fuson confining zone that will be addressed during the wellfield pump tests, particularly for Burdock Wellfields 1 and 2, where the potential breaches probably occur. EPA will review the information in the Injection Authorization Data Package Reports as described in Part II, Sections H and I of the Class III Area Permit to verify ISR operations can be conducted without endangerment to USDWs before authorizing injection into each ISR wellfield.

- 5. A number of commenters recommended that EPA review the 2002 USGS Report *Atlas of Water Resources in the Black Hills Area, South Dakota*, U.S. Geological Survey, Hydrologic**

**Investigations Atlas HA-747, by J.M. Carter, D.G. Driscoll, and J.E. Williamson, U.S. Geological Survey and V.A. Lindquist, West Dakota Water Development District that was prepared in cooperation with the South Dakota Department of Environment and Natural Resources and the West Dakota Water Development District.**

<https://pubs.usgs.gov/ha/ha747/>

Response #5:

EPA reviewed this report during evaluation of the Class III Permit Application and development of the UIC permits and the Cumulative Effects Analysis document.

- 6. A commenter raised concern that the EPA made statements in two places using the term “expected” when referencing conclusions about the geology. The first statement is that “the Lower Chilson is expected to provide adequate confinement....” (p. 66), and the second is that “The distance between the Chilson Sandstone potentiometric surface and the targeted ore zone...is expected be [sic] adequate to allow the drawdown required....” (pp. 68-69). The commenter expressed that these statements should be proven and not just “expected.”**

Response #6:

The commenter misinterpreted EPA’s intent in using the term “expected.” EPA reviewed all available data and information about the hydrology and geology in the project area. Based on this data, EPA was able to make these conclusions. However, these conditions described in EPA’s statements must be verified or proven by requirements in the Class III Area Permit before EPA will approve authorization to inject at Burdock Wellfield 6, 7 and 8.

Section 5.5.2 of the Fact Sheet for the draft Class III Area Permit discusses the available information on the thickness and lateral persistence of the local shale confining unit that separates the Lower Chilson aquifer from the Middle and Upper Chilson aquifer. Based on this information, the confining unit appears to be adequate to hydraulically isolate the Lower Chilson aquifer from the overlying Middle and Upper Chilson aquifers and allow sufficient hydraulic control of the wellfield injection intervals during ISR operations. Similarly, the information about the Chilson aquifer potentiometric surface discussed in Section 5.5.2 leads EPA to conclude that the injection interval will remain sufficiently saturated during ISR operation. The requirements in Part II, Section G.3 in the Class III Area Permit Class III permit are designed to verify hydraulic isolation and sufficient saturation of the Lower Chilson injection interval during ISR operations.

- 7. One commenter asserted that the secondary porosities in the Dewey-Burdock area are such that loss of containment and the escape of pressurized fluids from underground waste injection are almost a certainty should either mining or injection be allowed. The commenter further asserted that potential uranium contamination would be a risk to communities on the Pine Ridge Reservation (LaGarry and Yellow Thunder 2012), and the**

**transmission of uranium-contaminated water would be transmitted along regional faults (Bhattacharyya et al., 2012), among others.**

Response #7:

As part of EPA's review of the geology and hydrology of the site, EPA evaluated the effects of secondary porosity for the Dewey-Burdock project site. EPA's evaluation determined that injection zone fluids will be adequately confined. In addition, the Class III Area Permit requires the Permittee to verify this with the wellfield pump tests prior to approval of any injection.

The features that would contribute to secondary porosity in the Dewey-Burdock Project Area and surrounding areas are discussed in detail in Response #4 above.

While EPA agrees that uranium contamination of a drinking water aquifer would be a risk to a community, EPA's review and evaluation determined that no such risk exists.

The Arikaree aquifer is the largest source of ground water throughout the Pine Ridge Reservation. (Carter, J.M. and Heakin, A.J., 2007, *Potentiometric surface of the Arikaree aquifer, Pine Ridge Indian Reservation and Bennett County, South Dakota*, U.S. Geological Survey Scientific Investigations Map 2993, Sheet 2 of 2). The South Dakota Stratigraphic Correlation Chart shows that the Arikaree Formation is isolated from the uranium-bearing formations at the Dewey-Burdock project site by several hundred feet of low permeability strata. Fahrenback, M.D. et al., 2007, *South Dakota Stratigraphic Correlation Chart*, South Dakota Geological Survey, Oil and Gas Investigation Map 2993 shows the oldest formation present at the ground surface of the Pine Ridge Reservation is the Cretaceous Carlyle Shale. Examination of oil and gas well logs near the eastern border of the Pine Ridge Reservation show the top of the Fall River Formation to be about 1000 feet below the Carlyle Shale with Minnelusa Formation another 1400 feet deeper. The Dewey-Burdock injection zones are not in hydraulic connectivity with Arikaree Formation and are separated by hundreds of feet low permeability strata. The major fault zones, the Dewey Fault, located outside and northwest of the project boundary, and the Long Mountain Structural zone, located outside of and southeast of the project boundary, are southwest-northeast trending faults and would not direct subsurface fluids from the Dewey-Burdock project site toward the Pine Ridge Reservation. Response #239 below discusses EPA's analysis of the potential for injection activities at the Dewey-Burdock Project Site to impact the Arikaree aquifer and other aquifers at the Pine Ridge Indian Reservation. Based on this analysis, EPA has determined that ISR activity at the Dewey-Burdock site will not impact the Arikaree aquifer on the Pine Ridge Indian Reservation.

The commenter cites to two different sources to support the assertions about uranium contamination. These two references document uranium contamination on the Pine Ridge Reservation but do not indicate that injection activity in the Inyan Kara and Minnelusa aquifers at the Dewey-Burdock project site will impact the Arikaree aquifer.

- 8. A commenter questioned the integrity of the pump test data and associated information about the impacts of improperly abandoned boreholes, confining zone permeability, and the presence of faults and fractures. The commenter asserts that the permit does not include adequate mitigation measures to address the findings of the pump tests.**

Response #8:

As explained above in Response #4 and below in Response #14, the Permittee provided data meeting the requirements of the UIC regulations for issuance of a permit. EPA agrees with commenters about the importance of pump testing data to accurately characterize the Dewey-Burdock Project Area. Therefore, Part II of the Class III Area Permit requires the Permittee to perform extensive testing (including additional pump testing) prior to receiving authorization to inject in each wellfield. This pump testing, which is described in Section 5.4 of the 2019 Fact Sheet for the draft Class III Area Permit, will provide more detailed information about the thickness, integrity, and continuity of the Fuson confining zone and about hydraulic communication between the Fall River and Chilson Sandstone aquifers and the ground surface. It will also help the Permittee locate improperly plugged exploration boreholes. For more information on the effort to identify historic drillholes, see Section 4.2 of the 2019 Fact Sheet for the draft Class III Area Permit.

The results of the pump testing must be submitted in an Injection Authorization Data Package Report for each wellfield. EPA will evaluate the results of the pump tests so that any necessary mitigating measures can be implemented before EPA issues authorization to inject in each wellfield. Several provisions of the permits require evaluation and, where needed, mitigation of the potential for breaches in the confining zone:

- Part III of the Class III Area Permit requires that the Permittee perform corrective action to address any identified breach in a confining zone that could serve as a potential pathway for groundwater movement through an unplugged or improperly plugged exploration borehole, a well, or a natural geologic structure.
- Part II, Section D.4.b of the Class III Area Permit requires the Permittee to install monitoring wells in all aquifer units overlying the injection interval to detect any upward movement of injection interval fluids that may occur from a breach in the confining zones such as through a well casing or annulus. For more information, see Section 12.5.5.2.1 of the 2019 Fact Sheet for the draft Class III Area Permit.
- Part VIII, Section C.2 of the Class III Area Permit requires that static potentiometric water levels be measured in every monitoring well prior to the initiation of injection to establish the baseline potentiometric surface for comparison against water level measurements during injection operations. For more information on water level measurements, see Section 5.3.1 of the Fact Sheet for the draft Class III Area Permit.
- Part II of the Class V Area Permit requires verification of the integrity of the confining zone above the Minnelusa Formation in the Dewey-Burdock Project Area via logging in the injection wells and core sampling within the first well drilled through the Opeche Shale. See Section 3.3 of the Fact Sheet for the draft Class V Area Permit.

- 9. A commenter asserted that additional drilling in the alluvial deposits is needed to determine whether there is upwelling groundwater and should be done before further regulatory action is taken. The “several” drillholes suggested in the Class III Fact Sheet seems inadequate, but the number of drill holes is not specified.**

Response #9:

EPA agrees that it is important to understand the characteristics of the alluvium at the Dewey-Burdock Project site. As Section 4.3 of the Fact Sheet for the draft Class III Area Permit describes, the Permittee conducted an alluvial drilling program to characterize the thickness, extent, and saturated thickness of the alluvium along Beaver Creek and Pass Creek. Figure 12 of the Fact Sheet for the draft Class III Area Permit shows 15 alluvial wells were used to determine the potentiometric surface of the alluvium. Plate 3.6-4 from the South Dakota Large Scale Mine Permit Application shows that 46 drill holes were drilled into the alluvium to measure thickness and determine saturated thickness. Information was obtained from a total of 61 data points in the alluvium. The alluvial drilling program was designed to identify any potential discharge to the alluvium from underlying aquifers through breaches in the Graneros Group confining zone and to acquire baseline alluvial groundwater quality data for the Groundwater Discharge Permit application submitted to the South Dakota Department of Environment and Natural Resources (SD DENR). EPA determined this is an adequate number of data points to characterize the geohydrological conditions in the alluvium.

The alluvial deposits and alluvial groundwater will be further assessed during wellfield delineation drilling per Part II, Section B of the Class III Area Permit and formation testing per Part II, Section E of the permit. Water quality and water level data will be collected after the drilling and completion of the wellfield pump testing wells, which will include an additional 21 alluvial monitoring wells. This additional characterization will provide data inputs for the CSM and support the design of the non-injection interval monitoring well system.

**10. Commenters asserted that the proximity of proposed wellfields 6, 7, and 8 to the outcrop of the Fall River Formation complicates the ability to maintain hydraulic control of mining fluids and requested that the EPA require additional pump tests of the Chilson Sandstone prior to injection operations. One commenter referenced Plates 6.17 and 6.18 in the Class III permit application, stating that the potentiometric surface of the Chilson in the vicinity of wellfields 6, 7 and 8 is very close to the potentiometric surface of the overlying Fall River Formation. The commenter asserted that this suggests a connection through the Fusion Shale and that if partially saturated conditions develop and Powertech is unable to maintain an inward gradient in the injection zone, excursions are likely.**

Response #10:

EPA agrees that additional pump testing data are needed to fully understand the conditions in Burdock Wellfields 6, 7 and 8. As described in Section 5.5.2 of the Fact Sheet for the draft Class III Area Permit, the potentiometric surface of the Fall River aquifer falls below the formation top in the areas of Wellfields 6, 7, and 8. This means that the Fall River aquifer is partially saturated in this area (in Wellfield 8, the Fall River aquifer does not contain any groundwater). The Permittee does not propose any ISR operations in the Fall River sandstone units in those areas because a partially saturated aquifer does not offer ideal conditions for conducting ISR; rather, they propose to conduct ISR only in the underlying Chilson Sandstone at Burdock Wellfields 6, 7, and 8. However, once ISR operations begin and a cone of depression is created in each wellfield, the potentiometric surface will be drawn down lower than it is under pre-ISR conditions.

Part II, Section C of the Class III Area Permit requires the Permittee to conduct a pump test prior to operation of each wellfield to evaluate the integrity of the confining Chilson sand units, assess the ability to control injection interval fluids, and test the effectiveness of the wellfield monitoring system. The pumping rates used during the pump tests will simulate those that will be used during ISR operations and wellfield restoration to determine if the resulting drawdown of the potentiometric surface creates partially saturated conditions in the injection interval. If partially saturated conditions are created in wellfield 6, 7 or 8, the Class III Area Permit requires the Permittee to develop a 3-D unsaturated groundwater flow model for the areas where unsaturated conditions are anticipated. EPA will review the results of the pump tests before authorizing the Permittee to commence injection in each wellfield.

EPA disagrees with the interpretation that the potentiometric surface of the Fall River aquifer and the Chilson aquifer being at similar elevations in the vicinity of wellfields 6, 7 and 8 indicates leakage through the Fuson confining zone in this area. Figure D shows the potentiometric surface contours of the Fall River and Chilson aquifer based on water level measurements in wells completed in each aquifer.

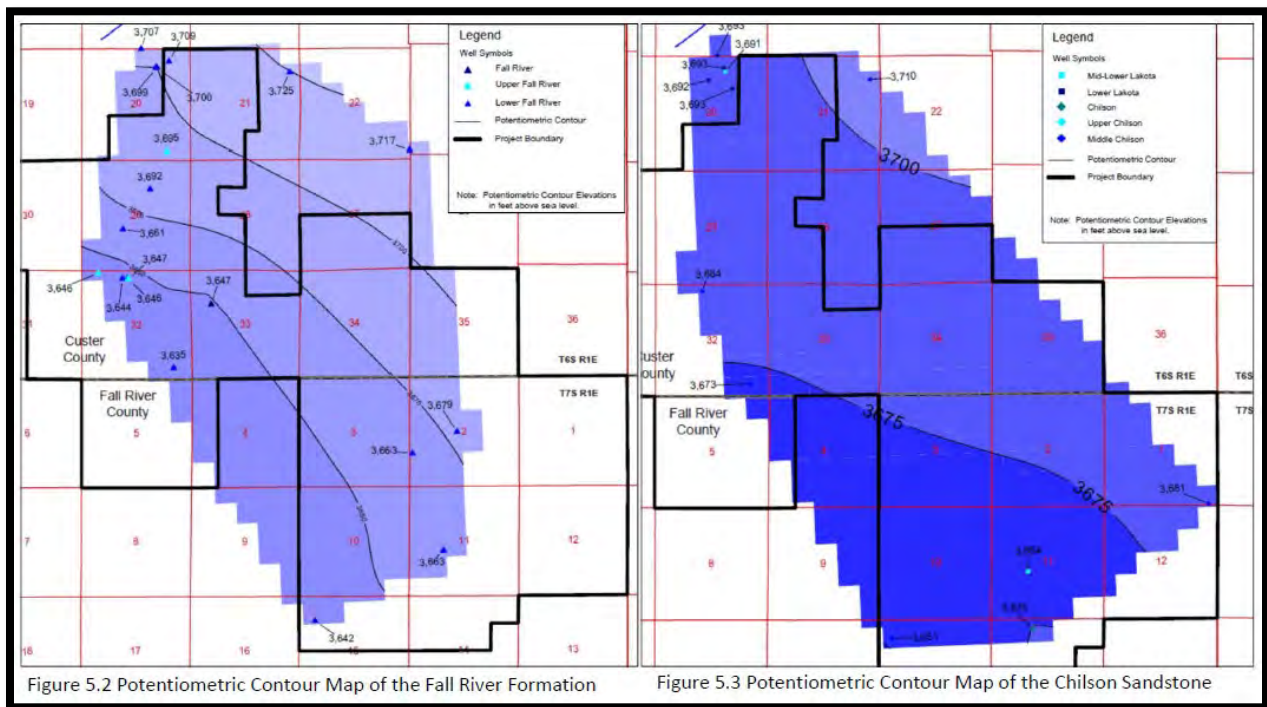

**Figure D. Potentiometric surface contour maps of the Fall River and Chilson aquifer from Figures 5.2 and 5.3 of the Class III Permit Application.**

These maps show that the potentiometric surface of the Fall River aquifer is at a higher elevation than that of the Chilson in the northeastern portion of the project area. The Chilson aquifer potentiometric surface is at a higher elevation than that of the Fall River aquifer in the southwestern portion of the project area. At some point these potentiometric surface elevations are at the same elevation, as demonstrated by the cross-sections shown in Plates 6.13 and 6.14 of the Class III Permit Application. EPA concludes that this is the reason for the similarity in elevation of the Fall River and Chilson potentiometric surfaces in the vicinity of Burdock Wellfields 6, 7 and 8.



**11. Commenters expressed concern about the potential for movement of fluids from the Class III and V injection zones to the water supply aquifers due to unpredictable events at the project. They assert that the flow between aquifers is not completely understood and may not be able to be modeled. Commenters reference a paper by Tank, R.W., 1956, about the Morrison Formation, stating that the formation's thickness varies widely and that there is a "marked difference" between the formation's composition in Edgemont and seven miles north of Edgemont. They further stated that the draft permits' heavy reliance on the Morrison formation as a confining layer should be re-considered, as the reality may not support the assumptions used in writing the draft permits. Finally, they assert that given the information that is available, and given the importance of this particular issue, it is irresponsible to "conclude" that mining fluids could be contained based on limited scientific information and weak analysis.**

Response #11:

EPA has extensively evaluated information about regional and local geology of the area where the Dewey-Burdock Project site is located and determined that the evidence supports the existence of adequate confining zones to protect USDWs by vertically isolating the Class III Inyan Kara injection intervals and the Class V Minnelusa injection zone to prevent vertical fluid movement out of the approved injection intervals or zone. Section 3.4 of Fact Sheet for the draft Class III Area Permit and Section 3.3 of the Fact Sheet for the draft Class V Area Permit discuss EPA's evaluation of confining zones. Additional evaluation of flow between regional aquifers is documented in this RTC document. (See Responses #120 and #239).

The major confining zones for the Class III injection intervals are the Graneros Group and Morrison Formation, which provide confinement above and below the Inyan Kara Group aquifers where Class III injection will occur. EPA reviewed the paper referenced by the commenter. Tank, 1956 states that in the Black Hills area, the Morrison Formation thickness ranges from a featheredge to 223 feet, averaging approximately 150 feet. (Tank, R.W., 1956, *Clay Mineralogy of the Morrison Formation, Black Hills Area, Wyoming and South Dakota*, Bulletin of the American Association of Petroleum Geologists, Vol. 40, No. 5, at 873) It is not unusual for a formation thickness to vary over a scale as large as the Black Hills Area.

In addition to generalized information about the Morrison Formation in this area, EPA also examined site-specific drill logs and cross sections from the Dewey-Burdock Project Area, which show the Morrison Formation thickness varies from 60 to 140 feet within the Project Area. Section 3.4.3 of the Fact Sheet for the draft Class III Area Permit discusses EPA's analysis of the Morrison Formation and the well field pumps tests designed to test the integrity of the Morrison Formation as a confining zone.

The focus of the Tank (1956) study was on the clay mineralogy present in the Morrison Formation. Tank noted differences in clay mineralogy at the different sections of the Morrison Formation examined for the study. The variation in type of clay is not a factor for the integrity of the Morrison Formation confining zone, since clays have similar low-permeability properties. Based on the analysis discussed in Section 3.4.3 of the Fact Sheet for the draft Class III Area Permit, EPA concludes that the Morrison Formation thickness, lateral continuity and mineralogical composition are appropriate for a confining zone.

While EPA's analysis of available information indicates there is adequate confinement, Part II of the Class III Area Permit requires the Permittee to perform extensive wellfield level testing to confirm adequate confinement and submit the results to EPA as part of Injection Authorization Data Package Report described in Part II, Section H prior to EPA authorizing injection in each wellfield. As discussed in Section 4.7 of the 2019 Fact Sheet for the draft Class III Area Permit, wellfield delineation drilling will provide more detailed information about the thickness, integrity, and continuity of the Fuson confining zone for wellfields targeting ore in the Chilson aquifer. Wellfield delineation drilling will provide more detailed information about the thickness, integrity, and continuity of the local confining zones for wellfields targeting ore in the Lower and Middle Chilson aquifer and the Lower Fall River aquifer. Section 4.7 also discusses how the wellfield level pump testing will provide information about the integrity of confining zone and help identify any breaches in confining zones, include improperly plugged exploration boreholes. Part III of the Class III Area Permit requires the Permittee to perform corrective action to locate and re-plug improperly plugged exploration boreholes in wellfield areas. For any improperly plugged exploration boreholes or other breaches in a confining zone that cannot be located or cannot be repaired, the Permittee must design wellfield operational controls to contain injection interval fluids to the injection interval and demonstrate that the number and placement of non-injection interval monitoring wells are capable of detecting any loss of hydraulic control in that area per 40 CFR § 144.55(b)(4).

One main measure of the Class III Area Permit to verify prevention of fluid movement into USDWs is the requirement to develop a robust conceptual site model (CSM) in Part IV. The CSM will represent the site-specific geologic, geochemical, and hydrogeologic characteristics and anticipated geochemical processes at the Dewey-Burdock Project. The model will be based on data collected to document site-specific geochemical and hydrogeologic conditions from pre-ISR conditions and throughout the duration of the project (including water quality data and the results of core sample analyses). As Section 15 of the Fact Sheet for the draft Class III Area Permit and the CSM support documents describe, the accuracy of the model—and, therefore, its utility in evaluating the potential for ISR contaminants to cross the aquifer exemption boundary—is improved by having quality data as representative as possible of the site both spatially and temporally. Knowledge of data gaps supports an understanding of the model's limitations and uncertainties, to help interpret the results and design data-collection programs to fill in these data gaps. The quality of the field data will be ensured by adherence to best practices for groundwater sampling, use of EPA-approved methods for groundwater sample analysis, and use of qualified professionals for aquifer testing, core analyses, and other types of tests, with quality assurance measures documented in the reports. The data submitted to EPA as part of required reporting will be reviewed by EPA staff. The modeling will be subject to calibration and sensitivity analyses and will be refined and validated as data are collected during the project lifecycle.

For the Class V injection, the Opeche Shale is the overlying confining zone for the Minnelusa injection zone separating it from overlying aquifers, and the Lower Minnelusa Formation is the underlying confining zone which separates the Minnelusa Class V injection zone from the underlying Madison Formation. In the Class V UIC permit application, the Permittee demonstrated the horizontal and vertical extent of these confining zones using data from oil and gas test wells surrounding the Dewey-Burdock Project Site to verify the presence and thickness of the confining zones for the Minnelusa injection zone.

Similar to the Class III Permit, the Class V Area Permit at Part II, Section A.1 requires additional testing to verify the presence and thickness of confining zones. Part II, Section B contains requirements for



drillhole logs, confining zone core collection and laboratory evaluation of core to verify the thickness and adequacy of the upper confining zone, the Opeche Shale. Sections 3.3.2 and 3.3.3 of the 2019 draft Class V Area Permit Fact Sheet discuss EPA's evaluation of the Lower Minnelusa confining zone that separates the overlying Minnelusa injection zone from the underlying Madison aquifer. These sections also discuss the Class V Area Permit requirements for verification of the Lower Minnelusa confining zone.

The commenters did not provide specifics to support the comment that the aquifers cannot be modeled or specific comments as to why the permit conditions would not be adequately protective of USDWs.

**12. Several commenters expressed concern about the variation in groundwater velocity values calculated for the Chilson and Fall River aquifers in published literature and in Powertech's application documents. Commenters stated that groundwater velocity is important for considering impacts on wells located downgradient of the mine site and requires further independent study before any permit is issued. Commenters also referred to transmissivity values and hydraulic conductivity values that had been determined for the aquifers. One commenter referenced a response in a pump test monitoring well located 1500 feet from the pumping well as equivalent to groundwater flow velocity.**

**Another commenter expressed concern about variable and high groundwater flow rates in the Minnelusa aquifer as shown in Figure 70 from Carter, Driscoll, Hamade, and Jarrell, 2001. The commenter stated flow from north of Dewey-Burdock to the SW has been measured at 591 feet/day, but flow south of the site has been measured at 7,393 feet/day. Once eastward flow is established, it's been measured at 4,349 feet/day to the east at the SD-WY state line, then 1,463 feet/day to the east in northern Fall River County and 732 feet/day to the east in central and southern Fall River County.**

Response #12:

EPA agrees that groundwater velocities in the Inyan Kara aquifers have important implications for impacts to downgradient private wells as well as ISR operations and monitoring. EPA also agrees that further analysis of the different groundwater velocity values determined for the Fall River and Chilson aquifer is important and sought contractor support for this analysis (see CADMUS, 2020, *Discussion of Information Related to Public Comments on Groundwater Velocities at the Dewey-Burdock Project Site*). Based on review of available information, EPA concludes that the permit requirements to conduct aquifer pump testing for each ISR wellfield will provide aquifer property measurements necessary for the Permittee to design, conduct and monitor ISR operations in a manner protective of USDWs. In addition, EPA concludes that the monitoring requirements in the Class III Area Permit are adequate for the protection of USDWs and private wells, irrespective of aquifer property measurements.

EPA was aware of the tritium analysis discussed in Gott et al., 1974, which presented data indicating a variable and high groundwater velocity in some areas of the Inyan Kara aquifers. The maximum groundwater flow velocity identified by Gott et al., 1974, as 15 feet/day (5,280 feet/year) in order for tritium rainout recharging the Inyan Kara in 1963 to travel from the aquifer recharge area to the well where it was detected in 1967, was referenced by the commenters.

As discussed in Response #4, EPA used Regional Applied Research Effort funding from the EPA Office of Research and Development (ORD) to work cooperatively with the USGS and the EPA ORD to conduct independent analyses of groundwater at the Dewey-Burdock site. This included sampling and analysis for tritium in 2011. Rahn, 2014, and Rahn et al., 2017, discuss and compare tritium analyses from Gott, 1974 and Johnson, 2012, as well as groundwater velocity values calculated from aquifer pump tests conducted in Inyan Kara aquifers at the Dewey-Burdock site by TVA. (Rahn, 2014, *Permeability of the Inyan Kara Group in the Black Hills Area and Its Relevance to a Proposed In-Situ Leach Uranium Mine*, in Proceedings of the South Dakota Academy of Science, Vol. 93; Rahn et al., 2017, *Tritium in groundwater in the Black Hills of South Dakota*, Environ Earth Sci (2017) 76:762; Johnson, 2012, *Geochemical Data from Groundwater at the Proposed Dewey Burdock Uranium In-Situ Recovery Mine, Edgemont, South Dakota*, USGS Open-File Report 2012–1070, Table 2.) Based on review of the CADMUS document, Rahn, 2014, Rahn et al. 2017 and Gott et al. 1974, EPA concludes that the 15 ft/day groundwater velocity is an anomalous value for the reasons discussed in Rahn, 2014 and Rahn et al., 2017, and summarized in CADMUS, 2020. Hydraulic conductivity is known to be a highly variable aquifer property; therefore, it is not surprising to see variability in groundwater velocity values calculated using hydraulic conductivity. As stated in Shackelford, 2013, hydraulic conductivity is among the most variable material properties in all of engineering. ([Shackelford, 2013, Geoenvironmental Engineering in Reference Module in Earth Systems and Environmental Sciences.](#))

EPA clarifies that transmissivity and hydraulic conductivity are different aquifer properties from groundwater velocity within an aquifer. Transmissivity describes the ability of the aquifer to transmit groundwater throughout its entire saturated thickness. Hydraulic conductivity relates to the ease with which water can move through an aquifer. Hydraulic conductivity can be determined by dividing the transmissivity of the aquifer by the aquifer thickness. ([Goulburn-Murray Water, 2015, Groundwater Terms and Definitions at 11-12](#)). Although hydraulic conductivity values may be expressed with the same units of measure as groundwater velocity (length or distance/time) they are not equivalent measurements. [Groundwater velocity may be calculated from hydraulic conductivity](#) by multiplying hydraulic conductivity by hydraulic gradient (change in aquifer potentiometric surface elevation) and dividing by effective porosity. Using this method, Rahn, 2014, estimated groundwater velocities to range from about 0.03 to 0.4 feet/day (11.5 to 142 feet/year) based on hydraulic conductivity values derived from TVA pump tests (Boggs and Jenkins, 1980; Boggs, 1983) in the Dewey and Burdock areas (Rahn, 2014, at 23-24). However, Gott, et al., 1974, (page 36) calculated groundwater velocity based on tritium results by dividing the distance from the aquifer outcrop to the well the groundwater sample was collected (4 miles) by a travel time between 1963 and the year the sample water collected (4 years) to arrive at a groundwater velocity of 15 feet/day (5,280 feet/year). If Gott, et al., 1974, had used the year 1958, another year noted on page 36 for peak tritium rainout, the calculate velocity would have been about 6 feet/day (2,347 feet/year).

Drawdown in a monitoring well during a pump test is not equivalent to groundwater velocity, but rather a response in the potentiometric surface resulting from pumping. As water is withdrawn from a pumping well, the change in hydraulic head (pressure) propagates through the aquifer rapidly. In contrast, groundwater velocity can be much slower because it is the measure of the travel time of a water molecule from one point to another through the aquifer.

**13. One commenter expressed that: “In two earlier opinions, including the one I submitted at the May 2017 hearings in Hot Springs, I described the “swiss-cheese” nature of the wellfield at Dewey-Burdock and its long-term lack of containment. This assessment was supported by the ASLB in that they imposed licensing requirements that Powertech exhume and properly close large numbers of potentially open holes. I fail to see the logic or benefit to moving a pressurized injection site closer to a demonstrably unconfined wellfield. It is as if you want to increase the likelihood of a pressurized leak.”**

Response #13:

EPA is aware of the existence of leaky historic drillholes (also referred to as “boreholes” by other commenters) in the project area. However, the Class III Area Permit contains many provisions that address this issue so that they will not cause an endangerment to underground sources of drinking water (USDWs). As discussed in Section 4.2.3 of the Fact Sheet for the draft Class III Area Permit, Part II of the Class III Area Permit requires the Permittee to take steps to identify leaky historic drillholes near the wellfield areas during the design and implementation of the wellfield pump tests (Section C), during the design of the wellfield monitoring system (Section D), during the implementation of formation testing (Section E), and during the implementation of the corrective action requirements in Part III. The Permittee must complete these actions prior to receiving authorization to inject, to prevent these drillholes, or any other type of confining zone breach, from acting as pathways for contamination of USDWs. This topic is further addressed below in Response #14. The commenter does not provide any comment about why these provisions are not adequate to protect USDWs.

EPA is also aware that the Atomic Safety and Licensing Board (ASLB) added a requirement to the NRC License requiring Powertech to attempt to locate and properly abandon all historic drillholes located within the perimeter well ring for a wellfield prior to conducting tests for a wellfield data package. As discussed in Response E, compliance with NRC’s requirements is outside the scope of our program and the actions before us. For purposes of the Safe Drinking Water Act UIC program, EPA has determined that Powertech documented an adequate investigation to identify improperly plugged historic exploration boreholes in the Class III Permit Application, which is in accordance with the UIC regulations. This is discussed below in Response #14.

**14. A number of commenters expressed concern about the existence of old boreholes at the site. The commenters urged EPA to require Powertech to identify and properly plug old boreholes at the site prior to the issuance of any permits.**

Response #14:

The UIC regulations do not require that the boreholes be plugged prior to issuance of a permit, nor does EPA find it necessary to do so to protect USDWs. The UIC regulations require an applicant to provide a map that includes abandoned wells and dry holes, but only information of public record and that which is known to the applicant must be included. 40 CFR § 146.34(a)(2).

Plugging and abandonment of old wells or boreholes is considered a corrective action under the UIC regulations. Corrective action requirements at 40 CFR § 144.55 do not require an applicant to either locate all wells or plug and abandon wells prior to issuance of a permit. Under this regulation, the

applicant must identify the location of “all *known wells*” and submit a plan consisting of such steps or modifications as are necessary to prevent movement of fluid into USDWs. It does not further prescribe specific corrective action measures.

In reviewing an applicant’s corrective action plan for adequacy, EPA must consider the factors in 40 CFR § 146.7. However, for Class III wells, EPA must also consider “the overall effect of the project on the hydraulic gradient in potentially affected USDWs, and the corresponding changes in potentiometric surface(s) and flow direction(s) rather than the discrete effect of each well. If a decision is made that corrective action is not necessary based on the determinations above, the monitoring program required in § 146.33(b) shall be designed to verify the validity of such determinations.”

EPA acknowledges the commenters’ concerns about the abandoned boreholes and recognizes their potential to be pathways of migration. However, the most effective way for EPA to require identification of any breaches and corrective action of them is through issuance of a permit.

The Permit includes appropriate wellfield testing and corrective action requirements that are protective of USDWs. The Permit requires the Permittee to design and implement wellfield pump tests to provide data that either verify there are no breaches in the injection interval confining zones or locate any naturally-occurring or man-made structures causing a breach in a confining zone. If the structure is man-made, corrective action can be performed to repair that breach. (See Section 5.4 of the 2019 Class III Fact Sheet; Class III Area Permit Part II, Section F and Part III, Section B). Pump test data and historical records will assist the Permittee in determining the location of leaky historic exploration drillholes. The Permittee indicated in Section 4.4 of the Class III Permit Application that attempts will be made to reenter improperly plugged exploration boreholes using a drill rig, followed by plugging and abandoning the drillhole according to current state regulations. Examples of corrective action for any wells causing a confining zone breach include repairing the well casing, adding cement to the annulus around the outside of the well casing, or plugging and abandoning the well.

If the structure is naturally occurring, such as a fracture or leaky area in a confining zone, or a borehole cannot be located, the corrective action method will be operational controls, such as adjustments in the location and pumping rates or injection pressure of production and injection wells to control lixiviant flow in that area. If these operational controls are used as the method of corrective action, Part III, Section B.4 of the Class III Area Permit requires the Permittee to demonstrate that the number and placement of non-injection interval monitoring wells are capable of detecting any loss of hydraulic control in that area.

### Class III Permit

#### Change of Ownership Affecting Permit Application

- 15. On the EPA’s public notice Powertech (USA) Inc. is listed as the operating company. If ownership has changed, shouldn’t Azarga Uranium now be the “Official Company” in which Azarga would need to go through the official permit application process from the very beginning? Shouldn’t the permit application be in the name of Azarga Uranium since now the Dewey-Burdock project is 100 percent owned by Azarga?**

Response #15:

The Underground Injection Control (UIC) regulations require that the owner or operator of a facility apply for a permit. In this case, Powertech USA Inc. is the owner of the company and will hold the permit as owner and operator. Powertech is a wholly owned subsidiary of Azarga Uranium Corp.

### **Concerns that Groundwater Cannot Be Returned to Baseline**

**16. A number of commenters expressed concern that groundwater cannot be returned to its original condition following in-situ recovery of uranium. Commenters asserted that groundwater has never been returned to its original condition at any In-Situ leach uranium mine in the U.S. and that these permits should not be issued until it can be demonstrated that groundwater resources will be protected. Commenters cited to the Kingsville Dome uranium mine in Texas where contamination from an ISL mine has spread throughout the aquifer to nearby drinking wells and to a USGS study that studied the effectiveness of groundwater restoration at ISL sites in Texas, finding more than half of the uranium production areas surveyed had higher levels of uranium in groundwater after mining and reclamation, than before mining began. Commenters also pointed out that all of the studied sites had received “amended restoration goals for at least one element after operators have expended a reasonable degree of effort to restore groundwater.”**

**As support for their assertions, commenters have cited to the following sources:**

- **J.K. Otton, S. Hall, “In-situ recovery uranium mining in the United States: Overview of production and remediation issues,” U.S. Geological Survey, 2009 (IAEA-CN-175/87), Hall, S. “Groundwater Restoration at Uranium In-Situ Recovery Mines, South Texas Coastal Plain,” USGS Open File Report 2009-1143 (2009), Darling, B., “Report on Findings Related to the Restoration of In-Situ Uranium Mines in South Texas,” Southwest Groundwater Consulting, LLC (2008).**
- **Kyllonen, D., & Peter, K. (1987). Geohydrology and water quality of the Inyan Kara, Minnelusa, and Madison Aquifers of the northern Black Hills, South Dakota and Wyoming, and Bear Lodge Mountains, Wyoming. Date accessed: 26 March 2017. Retrieved from: <https://pubs.usgs.gov/wri/1986/4158/report.pdf>**
- **Hydrogeologist, Dr. Roseanna Neupauer from the University of Colorado. She studied groundwater flow at an ISL mine in Christensen Ranch, Wyoming.**

Response #16:

EPA’s role in issuing a Class III permit is to prevent endangerment to USDWs *adjacent* to the mining aquifer. Because the ISR process will contaminate groundwater within the uranium ore zone, the ISR wellfield injection interval must be a non-USDW, either because it does not fit within the USDW definition at 40 CFR § 144.3 or has been exempted under the aquifer exemption process at 40 CFR § 146.4. The SDWA does not protect the water in exempted areas because they are not USDWs. Therefore, there are no UIC regulations requiring that water in the mining (i.e., exempted) area be returned to baseline conditions. As discussed elsewhere in this Response to Comment, groundwater

restoration of the mining area is generally outside the scope of EPA's UIC program and under NRC's UMTRCA authority.

The UIC regulations protect the USDWs around the exempted mining area. Therefore, while the UIC regulations do not protect the exempted aquifer, water quality within that area is still pertinent for purposes of protecting the nearby USDWs. The Class III permit includes many conditions to ensure that the USDWs adjacent to the mining aquifer are protected. Protective permit requirements include: extensive hydrologic, geologic and water quality characterization required under Part II that EPA must review before issuing authorization to inject into a wellfield; mechanical integrity testing (MIT) of all injection, recovery, and monitoring wells to prevent breaches in confining zones; wellfield pump tests to identify breaches in confining zones; corrective action requirements for any identified breaches in confining zones; and excursion monitoring and a Wellfield Closure Plan to demonstrate no ISR contaminants will cross the aquifer exemption boundary.

As part of its evaluation, EPA reviewed the sources cited by the commenters. EPA is aware of the findings from these reports that groundwater restoration of ISR wellfields has generally not been able to meet pre-mining concentrations for a number of ISR contaminants. However, nothing in these reports indicate that USDWs adjacent to the mining zone cannot be protected with the permit conditions in the Class III Area Permit. The Class III Area Permit requires the Permittee to develop Wellfield Closure Plans to demonstrate that no ISR contaminants will cross the aquifer exemption boundary.

- 17. Natural processes have not been proven to be effective in reducing the amount of uranium within groundwater (Mudd, 2001). Mining companies are unable to fully clean up the mess that they made, leaving the water and environment a dirtier and less safe place to live in. Mudd, G. (2001). Critical review of acid in situ leach uranium mining: 1. USA and Australia. Environmental Geology. 41(3). 390-403. Date accessed: 26 March 2017. Retrieved from: <https://link.springer.com/article/10.1007/s002540100406>**

Response #17:

EPA reviewed the information provided by the commenter. This information is not applicable at the Dewey Burdock site, as the report concerned acid in-situ leach uranium mining. At the Dewey Burdock project, the injectate does not contain acid. During the ISR process, the lixiviant will consist of wellfield groundwater with carbon dioxide and oxygen. The injection fluid limitations can be found in the Permit in Part VIII, Section H.

- 18. Some commenters expressed concern about the water quality conditions in the mining aquifer following restoration because of the Nuclear Regulatory Commission's Alternative Concentration Limit process. Commenters stated that "when companies can't restore water to baseline conditions or to the standards set by the NRC, the NRC simply raises the amount of contamination allowed. At some point, the restoration water 'fits' those raised standards, and the mine's water is declared 'restored.' This is unacceptable for the NRC, and it would be unacceptable for the EPA. The EPA must retain its baseline permit limits through a true restoration process. It is also important that standards are set at a true**

**‘baseline,’ which is the original condition of the project area’s water prior to uranium drilling or mining.”**

Response #18:

As explained in Response #16 above, UIC regulations do not protect the water in non-USDW areas and do not require that water in those areas are restored to baseline following a Class III mining operation. The Nuclear Regulatory Commission’s (NRC) Alternative Concentration Limit (ACL) process is outside the scope of EPA’s UIC program, and EPA has no role in its implementation.

EPA’s role is to prevent endangerment of USDWs adjacent to the mining aquifer. Therefore, the water quality of the restoration area within the aquifer exemption boundary is relevant to the UIC program. The water quality of the exempted aquifer is relevant to the extent that it must be restored to the level that there would be no movement of fluids into a USDW that would create a significant risk of health to persons.

Response #16 above provides a list of measures in the Class III Permit that prevent endangerment of USDWs outside the aquifer exemption area.

#### **Concerns Related to Water Quality Data**

**19. Commenters expressed concern that the UIC permit application is based on the same 2007-2009 water quality data that were included in the Nuclear Regulatory Commission (NRC) license applications and has not been updated.**

Response #19:

EPA agrees that updated water quality data are important to understanding the geochemistry of the Dewey-Burdock Project site. The water quality data provided in the Class III Permit Application met the requirements in UIC regulations. Part II, Section E of the Class III Area Permit requires the Permittee to collect water samples from both injection interval and non-injection interval monitoring wells prior to commencing injection and analyze the samples for a suite of 49 water quality parameters listed in Table 8. These parameters include: physical properties, groundwater-quality parameters related to the mobility of uranium and other metals, major cations and ions, total metals, and radiological parameters. The results of this sampling must be submitted to EPA as part of the Injection Authorization Data Package Reports required at Part II, Section H of the Class III Area Permit. EPA will evaluate the sampling results before it will authorize the Permittee to begin injection at the Dewey-Burdock site. The data will inform a geochemical modeling approach that will allow EPA and the Permittee to identify areas with the potential to have elevated concentrations of ISR contaminants and to focus monitoring and remediation efforts where needed.

**20. A commenter objected to the fact that the baseline water quality data to be collected under the permits will not be available for the public to review.**

Response #20:

This is consistent with the UIC regulations for Class III wells. The regulations specify that prior to issuance of a permit, EPA need only review the *proposed* formation testing program, which should be designed to collect specific data, including physical and chemical characteristics of the formation fluids. See 40 CFR § 146.34(a)(8); see also 40 CFR § 146.32(c)(3). Following construction of the well, but before EPA grants approval for operation of a Class III well, EPA must consider “all available logging and testing data on the well.” 40 CFR § 146.34(b)(1).

EPA acknowledges that water quality data will be collected after the UIC permits are issued. Part II, Section H of the Class III Area Permit and Part II, Section A of the Class V Area Permit require the Permittee to report on the results of formation water quality testing in Injection Authorization Data Package Reports before the Permittee may obtain authorization from EPA to commence injection. Because this information must be collected while the injection wells and monitoring wells are being drilled, the water quality sampling cannot occur before the UIC permits are issued.

The Permittee may not commence injection until EPA has reviewed the Injection Authorization Data Package Reports. EPA will review each report, and if EPA determines that the results of the testing do not confirm the information on which the permits are based, EPA will, as appropriate, require additional testing or modify the permit. If major modifications to the permits are warranted based on these new water quality data, EPA will modify the permits (along with all supporting data) and open those modifications for public comment following the administrative process at 40 CFR part 124.

As stated in Response #186 below, EPA has committed to posting the Injection Authorization Data Package Reports and EPA’s Authorization to Injection approval document on the Region 8 UIC Program website.

**21. One commenter asserted that additional data are necessary for a complete baseline analysis, including data on water quality constituents that were not in the permit application, such as strontium, tritium, and lithium.**

Response #21:

As explained above in Response #16, the UIC regulations do not require that the water in the mining zone be returned to baseline. This is because EPA is issuing an aquifer exemption for the mining zone, and the SDWA does not protect water in non-USDWs. Therefore, the UIC regulations also do not require that water quality baseline analyses be performed for the injection zone. EPA has determined that the Class III Permit Application provides adequate water quality data, which included analysis for strontium.

EPA agrees that additional data are necessary to characterize pre-mining water quality. In addition to the water quality data provided in the application, EPA is requiring collection of water samples in the Permit. Part II, Section E of the Class III Area Permit requires the Permittee to collect water samples from both injection interval and non-injection interval monitoring wells prior to commencing injection and analyze the samples for a suite of 49 water quality parameters listed in Table 8, including strontium. These water quality data must be submitted to and reviewed by EPA as part of the Injection



Authorization Data Package Reports required at Part II, Section H of the Class III Area Permit and Part II, Section A of the Class V Area Permit before the Permittee will obtain authorization to commence injection from EPA.

Lithium and tritium are not included in the Class III Area Permit as water quality parameters in Table 8 or as ISR contaminants in Appendix B, Table B-1 because there are no primary drinking water standards and no identified human health impacts for them.

According to the NRC Backgrounder on Tritium, Radiation Protection Limits, and Drinking Water Standards, *tritium is a naturally occurring radioactive form of hydrogen that is produced in the atmosphere when cosmic rays collide with air molecules. As a result, tritium is found in very small or trace amounts in groundwater throughout the world. It is also a byproduct of the production of electricity by nuclear power plants.* Tritium is not included in the Table 8 list of water quality constituents because it is not a uranium ISR contaminant. The first draft Class III Area Permit required determination of baseline water quality to use as a standard of comparison to evaluate compliance during post-restoration monitoring at a line of monitoring wells located downgradient from the restored Class III ISR wellfields. The purpose of post-restoration monitoring was to determine if ISR contaminants above pre-mining concentrations after groundwater restoration would cross the downgradient aquifer exemption boundary. Post-restoration monitoring is no longer required in the Class III Area Permit; therefore, the requirement to determine baseline water quality at a line of downgradient compliance boundary monitoring wells is no longer needed under the Class III Area Permit.

Instead of post-restoration monitoring, Part IV, Section B the final Class III Area Permit requires the Permittee to conduct reactive transport geochemical modeling with more targeting groundwater monitoring to evaluate the potential for ISR contaminants to cross the aquifer exemption boundary. Constituents EPA considers to be ISR contaminants under the Class III Area Permit are listed in Appendix B, Table B-1. Modeling results will become part of the Wellfield Closure Plan for all ISR wellfields required under Part IV, Section D. The Wellfield Closure Plan must demonstrate that the concentration of each ISR contaminant will not exceed the permit limit or the background groundwater concentration, whichever is greater, at the aquifer exemption boundary within the injection-interval aquifer.

Because the Class III Area Permit uses primary drinking water standards and other health-based standards as the permit limits for ISR contaminants at the AE boundary, baseline or background concentrations of ISR contaminants must be determined only if the naturally occurring background concentration already exceeds the permit limit. For constituents such as manganese, sodium and sulfate and occasionally iron and radium-226, Inyan Kara aquifer background concentrations exceed the permit limits. Therefore, the Class III Area Permit requires that concentrations of these constituents must meet background concentrations in the downgradient aquifer. Part II, Section E.2.b of the Class III Area Permit requires collection of groundwater samples from all wellfield monitoring wells to be analyzed for the water quality parameters in Table 8 of the Class III Area Permit. Part II, Section E.2.b.iv requires the Permittee to compare analytical results from samples collected from the downgradient wellfield perimeter monitoring well ring for ISR constituents listed in Table B-1 in Appendix B of the Class III Area Permit. If naturally occurring background concentrations for any constituent exceed the permit limit listed in Table B-1 in the groundwater downgradient from the ISR wellfield, the Permittee must determine background concentrations using the analytical results from the perimeter monitoring wells on the downgradient side of the ISR wellfield. Part II, Section E.2.b.v requires the Permittee to develop a

brief report that includes the analytical results and a description of statistical methods used for computing the background concentration for each constituent for which a background concentration is required and include the report in the Injection Authorization Data Package Reports per Part II, Section H.3.x for review and approval.

**22. In its Original EPA Letter, Powertech made numerous comments regarding the lack of justification for the additional constituents during baseline monitoring and that the constituents listed by the EPA were inconsistent with the NRC long-established monitoring programs. Despite modifying this list in the Revised Class III Draft Permit, EPA retained a total of 44 constituents or parameters in Table 8 of the Revised Draft Class III Permit. This is substantially greater than the 36 constituents or parameters required by the NRC and inconsistent with other ISR uranium operations licensed by the NRC in the USA, including Region 8. Powertech requests that Table 8 be made consistent with the NRC requirements for constituents.**

**Part II Section E, Table 8, pg. 14. This table lists a total of 45 parameters, several of which are not typically found in this geologic setting or are typically not found at levels of concern. We urge the EPA to remove the following parameters from Table 8 or require only one round of analysis to demonstrate the ions aren't present in baseline conditions (Aluminum, Antimony, Beryllium, Boron, Fluoride, Mercury, Nickel, Silver, Strontium, Thallium and Thorium). We suggest the EPA review the list of parameters that NRC requires in Table 2.7.3-1 of NUREG 1569 (also see language immediately above Table 2.7.3-1 that discusses the selection of parameters). EPA also proposes to significantly alter the parameter list for most groundwater samples, which would lead to confusion for Powertech and regulators in having to submit samples to a laboratory for two different analyte lists.**

Response #22:

EPA reevaluated the list of water quality parameters required under the Class III Area Permit in Table 8 to ensure it includes only the analytes needed to support and calibrate the geochemical modeling required under Part IV of the Class III Area Permit. EPA updated the list to include 49 constituents. EPA has determined that groundwater analysis for these 49 analytes is necessary to evaluate impacts the USDWs after wellfield groundwater restoration. Except for aluminum and thorium, the list of metals in the comment have primary drinking water standards or health-based standards; therefore, those were retained in Table 8.

In response to this comment, EPA has added provisions to the Class III Area Permit specifying that constituents may be removed from the analyte list for individual wells if the constituent is not detected in initial sample analysis. However, the constituent must be analyzed again at the end of groundwater restoration in the wellfield injection zone monitoring wells to determine if ISR operations released the constituent from solid phase to the groundwater.

In addition, the Class III Area Permit no longer requires the longer list of analytes in Table 8 for operational monitoring because these wells are outside the area where the Permittee is required to

develop geochemical models, EPA concluded that it is appropriate to use the NRC list of 34 parameters for operational monitoring included in NRC SEIS Table 7.3-1 *Background Water Quality Parameters and Indicators for Operational Groundwater Monitoring*.

**23. A commenter disagrees that additional water quality data cannot be obtained prior to construction of the wellfields and asserts that the baseline water quality data collection should not wait until after the wellfields are constructed.**

Response #23:

As clarified in several responses (see Responses #16 and #21), EPA is not requiring collection of water quality data for purposes of establishing a baseline groundwater quality within ISR wellfield injection intervals. As explained in Response #21, the requirement to determine baseline water quality at a line of downgradient compliance boundary monitoring wells is no longer required under the Class III Area Permit, because post-restoration monitoring of groundwater downgradient of the restored ISR wellfield is no longer required.

It is consistent with the UIC regulations to require that data on water quality be collected after issuance of a permit and before granting authorization to inject. This is discussed further in Responses #20, #35 and #36.

**24. Commenters also requested that the applicant be responsible for conducting and paying for baseline water testing in domestic wells.**

Response #24:

Part IX, Section B.2.a of the Class III Area Permit requires the Permittee to perform operational monitoring of all domestic wells within 1.2 miles (2 km) of the Project Area Boundary. Operational water quality monitoring also includes stock and monitoring wells within the Project Boundary.

**25. A commenter asserts that the Class III permit application does not adequately define pre-operational baseline water quality in the ore zones and peripheral zones, both vertically and horizontally.**

Response #25:

As discussed in previous responses, the UIC regulations do not require the permit application to define pre-operational baseline water quality. EPA determined that the water quality information contained in Appendices N and O of the Class III Permit Application was adequate for developing permit requirements protective of USDWs. Consistent with the regulations at 40 CFR § 146.34, Part II, Section H of the Class III Area Permit requires the Permittee to report on the results of formation water quality testing in Injection Authorization Data Package Reports. This water quality monitoring will target all formations of interest (including the formations containing uranium deposits, overlying alluvial aquifers, and the underlying Unkpapa Sandstone) from within, upgradient, and downgradient of the uranium ore

zones. EPA will review each report and, if EPA determines that the results of the testing do not confirm the information on which the permits are based, EPA will, as appropriate, require additional testing.

- 26. One commenter asserted that current conditions do not provide an adequate or accurate "baseline." All baseline measurements (ground and surface water, air, soil, sediment, etc.) should be defined as the original condition of the project area, before drilling and mining.**

Response #26:

As explained above in Responses #16 and #21, the UIC regulations do not require that groundwater in the project area be returned to baseline, and EPA UIC regulations do not require determination of baseline water quality concentrations. Since the permits are issued under the SDWA, permit requirements generally only pertain to the protection of USDWs. Therefore, the permit cannot require baseline measurements for surface water, air, soil, or sediments because these are not directly related to the protection of USDWs.

- 27. Powertech had a concern that there is an inconsistency between the NRC license and draft permit in terms of the parameters sampled during baseline monitoring in the perimeter monitoring wells, wells completed within the injection interval, and non-injection interval monitoring wells. License Condition 11.3 of SUA-1600 (Exhibit 016 in Powertech's Original EPA Letter) requires Powertech to sample these wells for the parameters listed in Table 6.1-1 of the approved NRC license application. Part II, Section E.2.b.iii would require Powertech to have samples from the same wells analyzed for a different set of parameters. Powertech has edited the list so that inconsistencies with the NRC license are made consistent. Since these wells typically would be within the exempted aquifer, Powertech questions the need to significantly expand the list of parameters beyond what was approved by NRC, especially since that list was taken directly from NRC guidance (NUREG-1569, Exhibit 012 in Powertech's Original EPA Letter) and reflects constituents typically affected by ISR operations. Overall, the addition of the extra parameters would add substantial cost without providing any added protection for USDWs beyond what is already required by NRC license requirements.**

Response #27:

As discussed below in Responses #80, 81, 84, and 85, the SDWA requirements are independent from UMTRCA requirements. Therefore, there is no requirement that obligations under either statute must be consistent with requirements of the other statute. EPA has determined that the water quality parameters listed in Table 8 of the Class III Area Permit are necessary for development and calibration of the geochemical model required under Part IV. The geochemical model is an important tool for assessing protection to USDWs.

- 28. Powertech requests omitting silica from the baseline water quality parameter list for the following reasons: a) it is not required by NRC license requirements (see Table 6.1-1 of the**

**approved NRC license application); b) Powertech could find no basis for requiring analysis of silica in all monitoring wells or for establishing compliance limits for silica based on the baseline sampling results; c) Even in the context of reactive transport modeling, the benefits of having silica data would be slight. The near neutral pH present in typical ISR lixivants will do little to dissolve silicate minerals.**

Response #28:

As discussed below in Responses #80, 81, 84, and 85, the SDWA requirements are independent from UMTRCA requirements. Therefore, there is no requirement that obligations under either statute must be consistent with requirements of the other statute. EPA has determined that the water quality parameters listed in Table 8 of the Class III Area Permit are necessary for development and calibration of the geochemical model required under Part IV. The geochemical model is an important tool for assessing protection to USDWs.

**29. Commenters requested that pre-mining, mining, and post-restoration phase water quality testing be done under the EPA's supervision or by a third party with no financial ties to the operator.**

Response #29:

EPA acknowledges the importance of appropriate and accurate water quality testing. However, self-monitoring and self-reporting are consistent with the SDWA and the UIC regulations. There is no requirement that testing be done under EPA supervision or by a third party. The documents reporting the results of tests and monitoring activities must be certified under penalty of law as complete, true, and accurate by the Permittee. See 40 CFR § 144.32(d).

While the permits do not specify what entity must perform required water quality testing, the groundwater and injectate monitoring provisions of the permits specify the analytical methodologies for each parameter to be monitored. EPA has identified the analytical methodologies to be used in the required water quality analyses in Part II, Section E.2 of the Class III Area Permit. The purpose of specifying the analytical methods, which have been approved by EPA for a variety of applications or meet ASTM standards, is to ensure that the analyses will be performed properly and yield accurate results.

The Permittee must report the results to EPA as part of the Injection Authorization Data Package Report required at Part II, Section H of the Class III Area Permit on a quarterly basis throughout the injection and restoration phases. The monitoring reports submitted to EPA typically contain copies of lab reports from an independent laboratory and quality control procedures are documented in the report. EPA reviews the quality control assessment provided by the laboratory as part of the compliance assessment process.

Additionally, the Class III Area Permit requires that sampling and analysis must be representative of the activities being monitored and contains requirements that the Permittee must follow to ensure this. For example, the general monitoring requirements under Part IX, Section A of the Class III Area Permit specify that all monitoring observations, measurements, fluid samples, etc., must be representative of

the activity or condition being monitored. This section of the permit also requires that the Permittee adhere to manufacturer's specifications for equipment and appropriate sample collection, handling, and chain of custody procedures.

The Injection Authorization Data Package Report must also describe the number and placement of monitoring wells in each wellfield. The monitoring system must be designed to provide early warning that there may be an incipient loss of control before an excursion plume would begin to develop. EPA will review the Permittee's proposed wellfield monitoring program to verify that the planned monitoring well locations are appropriate to demonstrate hydraulic control of injection interval fluids or to detect any potential excursions before authorizing injection.

**30. A commenter asserted that the use of low flow purge/sampling methods is too prescriptive.**

Response #30:

EPA removed the low flow purge/sampling requirements in the 2019 draft Class III Area Permit in response to this comment and replaced it with different requirements for stabilization criteria the Permittee must to meet before groundwater sample collection in order to assure that groundwater sample collected are representative of ambient conditions. Therefore, this comment is moot.

**31. One commenter expressed concern that leaching solution pumped into the aquifer makes contact with the ore and artificially dissolves the uranium, along with many other heavy metals. Further, they expressed that ISL mining occurring in the Inyan Kara aquifer results in associated injection of wastewater back into the Minnelusa aquifer and that all of Powertech's wastewater will contain heavy metals along with radioactive metals.**

Response #31:

While commenters are correct that uranium and other heavy metals will be released in the in-situ leaching process, they do not assert that the Permits are inadequate to ensure that these constituents will not impact USDWs. EPA provides the following information to address their concerns about the leaching process. The ISR process will release additional heavy metals into the groundwater along with uranium. Based on the analysis of the uranium ore, arsenic, vanadium, selenium, molybdenum, and iron are also present in the ore deposit. The Class III Area Permit requires groundwater samples to be analyzed for these constituents, and other metals with primary drinking water standards or health-based standards. The Class III Area Permit requires the Permittee to conduct reactive transport geochemical modeling to evaluate the potential for ISR contaminants to cross the aquifer exemption boundary. Constituents considered to be ISR contaminants under this Area Permit are listed in Appendix B, Table B-1. Part IV, Section D of the Class III Area Permit requires the Permittee to use modeling results to develop a Wellfield Closure Plan that must demonstrate that the concentration of each ISR contaminant will not exceed the permit limit or the background groundwater concentration, whichever is greater, at the aquifer exemption boundary within the injection-interval aquifer.

For a response to the Class V concerns, please refer to Responses #137 and #138 below.

### Permit boundary

**32. Part II, Section A, pg. 6. requires wellfields to be at least 1,600 feet from the Permit Area boundary (0.3 miles). The determination of this distance seems arbitrary and is overly restrictive while providing little or no benefit. We believe this distance sets an unreasonable precedent that will likely prevent the complete recovery of mineral resources at future mines. A science-based approach to determine this distance is in order. We suggest the EPA work with the proponent to determine an appropriate minimum distance between the wellfields and the permit boundary that is protective of surrounding USDWs (with sound technical justification consistent with requirements of the NRC and other states) while at the same time allowing for recovery of the majority of the resource.**

Response #32:

The buffer zone inside the Dewey-Burdock Project Boundary was proposed by the Permittee, not EPA. As stated in Section 10.3.1 of the Class III Permit Application, the Permittee did not intend to have any portion of the ISR wellfields located within 1,600 feet of the project boundary in order to establish an operational buffer between the wellfields and the Area Permit Boundary. After reevaluating extent of the uranium ore bodies, the Permittee has updated the buffer to 1,000 feet. The UIC regulations do not specifically address a buffer zone.

**33. A commenter had concerns about narrowing the buffer zone between injection and production wells and the Project Area Boundary from 1600 feet to 1000 feet and expressed that it was unwise. The only reason given is that Powertech changed its mind and “updated” its estimate of buffer width. This is a justification without a scientific basis.**

Response #33:

As stated in the previous response, EPA included this requirement in the Class III Area Permit because the Permittee stated in Section 10.3.1 of the Class III Permit Application that no wellfields will be located within 1,600 feet of the project boundary in order to establish an operational buffer between the wellfields and the Area Permit Boundary. After reevaluating extent of the uranium ore bodies, the Permittee has updated the buffer to 1,000 feet. The Permittee does not plan to locate any injection and production wells within the 1,000-foot buffer zone; however, wellfield perimeter monitoring well rings will be located within the buffer zone. Figure 24 of the 2019 Fact Sheet for the draft Class III Area Permit shows this buffer zone. UIC regulations do not require the establishment of a buffer zone for Class III wellfields. The 1,000-foot buffer zone is included as a requirement under Part II, Section A of the Class III Area Permit; however, the Permit relies on other permit requirements such as excursion monitoring and Wellfield Closure Plan for protection of USDWs rather than this buffer zone.

### Wastewater from pump tests

**34. There is one statement in the Class III Fact Sheet that created more questions than it answers. This is the statement that “Groundwater pumped to the surface during the**

**pump tests will not be injected back into the subsurface” (p. 59). The obvious question, of course, is what will be done with this waste water? Will it be allowed to run into the ground and/or the creeks? What will its quality be? Is this waste water included in the calculations of the amount of water consumed during the project? At a minimum, the answers to these questions should be included in the discussion.**

Response #34:

The Class III Area Permit and Fact Sheet do not address the water produced from the pump test because the Permittee did not propose injecting the water back into the subsurface. Therefore, it is outside the scope of the UIC program.

The groundwater pumped from the Fall River and Chilson aquifers was allowed to drain onto the ground surface; it is likely that Powertech will follow the same protocol for future pump tests. A summary of groundwater quality data is provided in Appendix N of the Class III Permit Application; Appendix O provides more detailed analytical results for all the groundwater samples collected and analyzed. The groundwater quality is similar to that of the private drinking water wells and stock watering wells within the Dewey-Burdock Project Area. Although it is beyond the scope of the UIC Program’s regulatory authority, EPA does not have any concerns about the water quality of the groundwater released onto the ground surface during the pump tests. The volume of groundwater pumped from the Inyan Kara aquifers during the pump tests already performed and those that will be performed was not included in the calculations of the amount of water consumed during the project.

#### **Timing of wellfield testing/sampling**

**35. A commenter asserted that EPA should require the additional pump tests that will be necessary prior to full permitting under UIC. The commenter claimed that NRC is requiring these tests prior to operations and said EPA should not be pressured to permit this project in order to obtain the necessary data on its environmental safety parameters.**

Response #35:

EPA is requiring formation testing prior to granting authorization to inject and operation of the wells. However, EPA must issue the Permit in order to establish the appropriate standards for construction and testing and to ensure that the standards are enforceable. This is consistent with the UIC regulations for Class III wells. The regulations specify that prior to issuance of a permit, EPA need only review the proposed formation testing program, which should be designed to collect specific data, including physical and chemical characteristics of the formation fluids. 40 CFR § 146.34(a)(8); see also 40 CFR § 146.32(c)(3). Following construction of the well, but before EPA grants approval for operation of a Class III well, EPA must consider “all available logging and testing data on the well.” 40 CFR § 146.34(b)(1).

**36. A number of commenters expressed concern that wellfield testing and sampling will be performed after permit issuance. They were concerned that the information will not be subject to public review or comment, and key information would become available only after permits have been granted. They requested that all required testing be done prior to**



**permit issuance and that the information be available for public review and comment. The information commenters referred to included: tests to establish groundwater flow and geochemistry, identify faults, determine confining zone integrity and thickness, delineate the wellfields, and demonstration the effectiveness of monitoring systems.**

Response #36:

As described above in Response #35, detailed wellfield testing and sampling should be performed under standards set in the Permit, following permit issuance. The Permittee will not be allowed to inject into the wells until after submittal of the injection authorization data package report and EPA reviews and can confirm that the Permittee has met all the requirements under Part II, Section I. The detailed requirements set out in this section include among other things: a map and cross sections of ore deposits; a map of injection, production and monitoring wells; logging and testing results for all wells; demonstration of overlying and underlying confining zones; performance of corrective action, mechanical integrity of the wells; groundwater water quality testing results; wellfield pump test data; and characterization of faults, fractures, and lithologic variability that might provide preferential flow paths or otherwise affect groundwater flow. Part II, Section H includes the complete description of requirements for the Injection Authorization Data Package Reports.

The draft permit that was available for public comment detailed the extensive data and testing requirements. The public also had the opportunity to review what the Permit requires the Permittee to demonstrate to EPA with this data and testing in order to be issued an authorization to inject and begin operations. This process is in accordance with the regulations at 40 CFR § 146.34.

If the information acquired during wellfield testing leads to a major modification of the permit under 40 CFR § 144.39, the public will have the opportunity for notice and comment on those proposed modifications.

### **Limit on Number of Wells**

**37. Some commenters were concerned that the Class III area permit does not set a limit in the number of wells that can be authorized. They stated that there should be a limit on the number of wells allowed under the permit, and that the limit should be conservatively set by the EPA.**

Response #37:

The UIC regulations do not place a limit on the number of wells that can be authorized under a UIC area permit. EPA's review included an analysis of cumulative effects, as required by 40 CFR § 144.33. Based on this review, EPA determined that cumulative effects from the drilling and operation of the additional wells are acceptable. While the final AE ROD describes the project as having 14 wellfields containing approximately 1,461 Class III injection wells and 869 production wells, the wellfields will be phased and will not operate all at once. If at any time EPA finds cumulative effects to be unacceptable, the permit may be modified under 40 CFR § 144.39. See 40 CFR § 144.33(d).

## Well Construction and Mechanical Integrity

- 38. One commenter expressed concern about the open-hole completion for well construction: “Mines being allowed to leave holes open deliberately weakens injection aquifer containment. These holes will join over 4,000 other potentially problematic wells in the Dewey-Burdock wellfield, along with numerous faults, fractures, and breccia pipes. In 30 [years] as a geologist I have never seen a more poorly considered location for ongoing mining or injection. Open holes at the mine should automatically disqualify nearby injection and vice versa.”**

Response #38:

It is not clear from this comment whether the commenter has the same understanding of an open hole completion as the Class III Area Permit contemplates. Part V Section E.5 of the Class III Area Permit states that after the well casing has been installed and cemented in place (allowing 24 hours for the cement to set up), the Permittee may choose to complete the well using either a well screen or by leaving an open hole through the target injection interval. The wells will still only be completed in the injection zone, and the construction requirements do not allow for the movement of fluids into other aquifers. The purpose of a well screen is not to prevent fluids from moving through the wellbore into other aquifers but to prevent sediment from entering the well. Therefore, whether or not the wells have a screen will not affect containment of fluids. See EPA, Learn About Private Water Wells, Well Location and Construction <https://www.epa.gov/privatewells/learn-about-private-water-wells#construction> (last visited, October 9, 2020) (Well Screens are attached to the bottom of the casing to prevent too much sediment from entering the well.); 1991 EPA *Handbook of Suggested Practices for the Design and Installation of Ground-Water Monitoring Wells*, EPA160014-891034 (Artificial filter packs and screened intakes are also often required in poorly-consolidated formations to minimize potential caving of the borehole and/or to reduce turbidity in water samples collected from the completed well. In some consolidated formations, the well may be completed as a cased borehole with no screen intake or filter pack).

- 39. Part V, Section E(4), pg. 33 requires 120% of the calculated volume be used. This statement isn't clear since I assume the EPA isn't requiring the cement be forced with pressure into the open hole. We assume the statement means the permittee must prepare at least 120% of the calculated volume. This practice will result in the waste/disposal of cement. We encourage the EPA to allow the permittee to prepare 100% of the calculated volume. Any remaining void should be top filled after the cement has cured.**

Response #39:

The volume of cement specified in the permit is required by regulation and can be found at 40 CFR §147.2104(d), which states that the owner or operator must, as required by the Regional Administrator: “(2) isolate any injection zones by placing sufficient cement to fill the calculated space between the casing and the well bore to a point 250 feet above the injection zone; and (3) use cement . . . (iii) in a quantity no less than 120% of the calculated volume necessary to cement off a zone.”

Any remaining void in the annulus cement would be top-filled after the cement has cured. EPA believes that the permit requirement as stated gives the Permittee the flexibility to prepare the cement at different stages of the well construction phase as needed to completely fill the annulus between the drillhole and the well casing. The Permittee must ensure that the end result of the cement job for each Class III well meets the requirements for demonstration of external mechanical integrity under Part VII, Section D of the Class III Area Permit, or remedial cementing may be required if the well cement is shown to be inadequate as a demonstration of external mechanical integrity, as stated under Part VII, Section D.

**40. Part VII, Section C(4)(d) states the permittee may use air to induce pressure during an MIT. Instead of using “air” we suggest the permittee be allowed to use “compressed gas” which could include air.**

Response #40:

EPA determined using the term “compressed gas” to replace “air” was advantageous because it gave the Permittee the option to use a compressed gas, including air, to induce pressure during an internal mechanical integrity test; therefore, EPA made this change in the final Class III Area Permit. EPA determined that the type of compressed gas used to pressurize the well casing will not affect the mechanical integrity test result and therefore will not affect protection to USDWs.

**41. Some commenters expressed a concern about the potential for well casing to fail, causing contamination of the environment. One commenter stated that the cement casings of mining wells using high pressure fluids have well documented fail rates. Other commenters generally expressed concern that failure of the injection technology could result in contamination to groundwater. In support of their concern, some commenters referenced the large number of leaking injection wells reported in a June 21, 2012 ProPublica article.**

Response #41:

EPA acknowledges that well failure can lead to the contamination of adjacent aquifers. However, the commenters did not offer any comments that the permit conditions in the Permit are inadequate to address concerns about well failure.

Class III wells: Part V of the Class III Area Permit contains well construction requirements for the mining injection wells designed to ensure mechanical integrity. Class III PVC well casing must meet strength and thickness requirements. The well casing is cemented in place to fill the void between the outside of the well casing and the drillhole. The Permittee must demonstrate initial mechanical external for all Class III wells before commencing injection and conduct mechanical integrity tests every 5 years. Class III uranium recovery wells do not need to inject at high pressures, because the recovery wells are pumping out a greater volume of groundwater than the injection wells are injecting.

Part VII of the Class III Area Permit contains requirements for demonstrating and maintaining mechanical integrity for Class III injection wells. The Class III Area Permit also requires demonstration of

external mechanical integrity for monitoring wells and production wells. External mechanical integrity is demonstrated through cementing records; therefore, as described under Part VII, Section D of the Class III Area Permit, the monitoring program required under Part II, Section D must be designed to verify the absence of significant fluid movement through the confining zones per 40 CFR § 146.8(c)(4).

Class V wells: Part III of the Class V Area Permit contains stringent well construction requirements. The Class V Permit also includes several provisions designed to address mechanical integrity of the wells. Part IV, Section L requires the Permittee to ensure that the tubing-casing annulus fluid is maintained under an induced pressure at all times. The Permit requires the tubing-casing annulus pressure to be maintained at a minimum of 100 psi above the injection pressure. In the Final Permit, Part V, Section D.3, Table 15.A requires continuous monitoring of the pressure on the tubing-casing annulus. Continuous monitoring allows for immediate detection if tubing-casing annulus pressure drops below 100 psi above the injection pressure. If this pressure cannot be maintained, the Permittee must cease injection and inspect the long string casing, cement and the injection tubing and test for mechanical integrity. Part II, Section A.8 requires demonstration of internal and external mechanical integrity for each injection well before EPA authorizes injection into each well. Part V, Section C, Table 12 requires internal and external mechanical integrity tests be conducted every 5 years. Part III, Section L.4. requires a successful demonstration of internal mechanical integrity following the completion of any well workover or alteration which affects the integrity of the casing, packer or tubing. Injection operations must cease until the well has successfully demonstrated mechanical integrity.

The Class V Area Permit has a number of requirements for demonstration of external mechanical integrity for early detection of any channels through the cement sealing off the annulus between the borehole and the external well casing. Part II, Section H.3 requires the Cement Bond Log (CBL) to demonstrate 80% bonding through the confining zones to demonstrate external mechanical integrity. In UIC Class II permits, if a cement bond log demonstrates at least 80% bond through confining zones the Permittee is not required to conduct any further demonstration of external mechanical integrity. In the Class V Area Permit, Part II, Section I, Table 10 requires an initial temperature or radioactive tracer survey test to provide a baseline assessment of external mechanical integrity in addition to the CBL.

**42. Page 40, Part VII, Section C.3 - South Dakota's Underground Injection Control Class II rule ARSD 74:12:07:18 requires a minimum 15 minute time period for pressure fall-off and wellhead pressure tests. Based on the rule and to ensure testing procedures are consistent with existing Class II wells in the vicinity of the proposed project, DENR recommends EPA require the internal mechanical integrity tests to run for a minimum of 15 minutes rather than the 10 minutes proposed in the draft permit.**

Response #42:

EPA clarifies that the 10-minute duration of the internal MIT in Part VII, Section C of the Class III Area Permit is an appropriate test duration based on the planned the well construction materials. A pressure test duration of 10 minutes is often used in MITs for wells of similar polyvinyl chloride (PVC) construction to avoid damaging the well during the MIT. This MIT duration has been used in other Class III wells in Region 8 operating under similar geologic conditions.

**43. Powertech requests removal of the requirement to receive written authorization from the Director for a successful MIT prior to commencing operation of injection and production wells constructed after the Authorization to Commence Injection is issued. The requirement to obtain Director approval for wells that successfully pass MIT is inconsistent with License Condition 10.5 of SUA- 1600. If the well passes MIT, Powertech should have the capability of operating the well immediately, in conformance with the approved NRC license.**

Response #43:

EPA cannot remove the approval requirement from the Director following a successful MIT prior to allowing Powertech to commence operation of a well. This is explicitly required by the UIC regulations. The regulation states: "Prior to granting approval for the operation of a Class III well the Director shall consider the following information: (2) A satisfactory demonstration of mechanical integrity for all new wells and for all existing salt solution wells pursuant to § 146.8." 40 CFR § 146.34(b)(2). Therefore, while EPA will issue an Authorization to Commence Injection by wellfield, Powertech will still need to submit a satisfactory demonstration of mechanical integrity for each well and receive a written approval from EPA prior to injecting into a well. This requirement can be found in the Class III Permit at Part VII, Section B.4.

As explained in Responses #72 and #81, EPA permits do not need to mirror the NRC's license, as the permits are issued under the authority of the SDWA and must meet all of its requirements. Further, the requirement to obtain EPA approval of the successful MIT does not conflict with the NRC license because it does not cause Powertech to be out of compliance with the NRC license.

**44. Powertech requests removal of the requirement to obtain written approval from the Director for a successful MIT following well stimulation, workover or alteration. Requiring such written approval before resuming operations is inconsistent with License Condition 10.5 of SUA- 1600. If the well passes MIT, Powertech should have the capability of injecting into the well immediately, in conformance with the approved NRC license.**

Response #44:

The requirement to demonstrate mechanical integrity and obtain approval to inject following a well stimulation, workover, or alteration is consistent with the UIC regulations. These actions can affect the mechanical integrity of well. From that perspective, the potential endangerment to USDWs is no different than when a new well is constructed or an existing well loses mechanical integrity. In both these situations, the UIC regulations require that the permittee demonstrate to the satisfaction of the Director that a well has mechanical integrity. See 40 CFR §§ 146.34(b)(2) and 144.52(a)(8), respectively.

As explained in Responses #72 and #81, EPA permits do not need to mirror the NRC's license, as the permits are issued under the authority of the SDWA and must meet all of its requirements. Further, the requirement to obtain EPA approval of the successful MIT does not conflict with the NRC license because it does not cause Powertech to be in noncompliance with the NRC license.

**45. Definition of MI in Fact Sheet unclear: One omission is simply the failure to provide a very important definition in the section of the Class III Fact Sheet related to mechanical integrity. This is the statement that internal mechanical integrity and external mechanical integrity will both be confirmed if “There is no significant” leak or fluid movement. The document needs to provide a clear, measurable definition of “significant” in each case.**

Response #45:

The definition of mechanical integrity in the fact sheets and permits are taken directly from the UIC regulations. This can be found at 40 CFR § 146.8(a) and states: “An injection well has mechanical integrity if: (1) There is no significant leak in the casing, tubing or packer; and (2) There is no significant fluid movement into an underground source of drinking water through vertical channels adjacent to the injection well bore.”

To clarify how the Permittee will demonstrate the absence of a “significant” leak in the well casing, the Permittee must demonstrate internal mechanical integrity using a pressure-packer test according to the procedures in Part VII, Section C of the Class III Area Permit. If the testing pressure drops less than 10 percent during the 10-minute test, the well casing is demonstrated to have acceptable mechanical integrity. Demonstration of external mechanical integrity will be provided via the submittal of and EPA’s review of detailed cementing records to demonstrate there is adequate cement filling the annulus between the outside of the well casing the drillhole wall to prevent voids that could serve a pathways for fluid migration outside the injection interval. Because cementing records will be used to demonstrate external mechanical integrity, the monitoring program requirements in Part IX of the permit must be designed to verify the absence of significant fluid movement outside the injection interval through confining zones as required under 40 CFR § 146.8(c)(4).

**46. South Dakota DENR recommends EPA have an inspector on-site to witness the initial and ongoing mechanical integrity testing of the Class III Area Permit wells.**

Response #46:

Part VII, Section H of the Class III Area Permit and Part V, Section C of the Class V Area Permit require the Permittee to notify EPA in advance of any regularly scheduled MIT after the initial MITs have been performed to provide EPA an opportunity to witness these MITs. EPA will make every effort to be present for Class III injection well MITs, but this is not required by the UIC regulations. As shown in Figure 5 of the Aquifer Exemption Record of Decision, which shows Powertech’s Time Table for Project Development, initial mechanical integrity testing of Class III injection wells will be an ongoing procedure as wellfield construction will be continuously underway for the first eight years of the project. Therefore, it will not be possible for EPA to be present for all MITs. EPA must review documentation of all MIT records to ensure each test was performed correctly. If there is reason to believe a test was not conducted properly, EPA will request re-testing, and if appropriate witness the follow-up test.

## Change in Annual Requirement to Construct to Annual Reporting

- 47. Removing the requirement that Powertech begin construction within one year of the permit effective date and allowing the company to file minimal annual reports to maintain its permit. Is it a requirement that the company begin construction within one year of the permit effective date, as the 2017 Draft Permit says? There is probably a reason that this requirement was put in place. One reason is that we don't want the countryside littered with "zombie" permitted mines that are inactive, and that are part of a dying industry, but that somehow manage to remain minimally "alive." This would create tremendous uncertainty for the many landowners with whom Powertech has leases, as well as keep the general public on edge. Deny the permits. Give landowners and the public certainty.**

Response #47:

EPA clarifies that the provisions that allow for deferred construction are to allow time for obtaining permits that must be issued by the State. Following EPA's issuance of a final UIC permit decision, the State of South Dakota permitting processes must still be completed before the Permittee may begin work at the project site. To address any changes within the Area of Review (AOR) that might occur during this time frame, Part V, Section H of the Class III Area Permit requires the Permittee to submit an AOR update annually to EPA until wellfield construction commences. The required AOR update must include: identifying the location and screened interval of any new wells within 1.2 miles (2 km) of the potential wellfield areas; performing a capture zone analysis for each new drinking water well that is constructed within the AOR; and adding the new well to the list of operational monitoring wells. The Permittee must also notify EPA prior to commencing construction activities and may not commence construction without EPA approval. The burden of this requirement, along with requirements and expiration dates of the Class V Area Permit and the NRC License, will induce Powertech close the operation if the company does not plan to go forward with the operation.

## Pumping Rates

- 48. Commenters requested clarification of the pumping rates to be used during the mining process. One commenter requested that a water budget analysis be performed to estimate reductions in flow and groundwater discharge from the Fall River and Chilson aquifers.**

Response #48:

Section 9.3 of the Fact Sheet for the draft Class III Area Permit discussed the various components of the project flow rate. Figure 26 breaks down the various flow streams involved in tracking the project wide flow rate. Table 18 of the Fact Sheet for the draft Class III Area Permit summarizes the project-wide flow rate. Note that the flow rate is not the same as the amount of groundwater lost from the aquifer during the project. The amount that is lost to the aquifer is represented under the Bleed rate column in Table 18, which will reach a maximum of 75 gallons per minutes when both ISR activities and groundwater restoration are occurring at the same time. During uranium recovery operations, the estimated injection rate will range from about 7,760 to 7,960 gallons per minute (gpm) but is expected to be approximately 7,930 gpm most of the time. The expected injection rate for groundwater restoration may range up to

495 gpm, and during concurrent uranium recovery and groundwater restoration operations, the injection rate will be 8,425 gpm. EPA performed a more detailed breakdown of the flow rates for each wellfield in the spreadsheet entitled ProjectFlowRates.xls included in the Administrative Record.

#### **Water level at wellfield perimeter monitoring wells**

**49. Part VIII, Section F(4)(b)(i), page 44, requires the water level at the perimeter monitor wells be consistently lower than baseline levels to demonstrate hydraulic control. While it is possible to generally maintain the water level at these measurement points lower than baseline, it will be impossible to keep the water levels below baseline values “consistently.” For example, if a single downhole pump breaks down, a resulting pressure wave will quickly migrate out to the monitor well ring and could cause the local water level to temporarily exceed baseline. A temporary pressure wave like this does not indicate that hydraulic control has been lost. However, extended time periods with elevated water levels is an indication that hydraulic control has been lost or may be lost. We recommend the wording be changed to either require a specified percent bleed rate (typically 0.5 to 1%) or allow the permittee a specified time to bring the water level below the baseline level (on the order of one week).**

Response #49:

The requirement is not intended to be as restrictive as the commenter has interpreted. The requirement applies to the water level in all of the wellfield perimeter monitoring wells collectively, which provides the flexibility for the water level in individual wells to fluctuate occasionally above baseline. The requirement has been clarified in the Final Permit and now states: “monitoring water levels in the injection interval perimeter monitoring wells that are consistently below the baseline water levels established under Section C.2 of this Part the majority of the time.”

#### **Constituent Levels**

**50. EPA documents fail to describe, consider or analyze the difference between inorganic and organic forms of the same compounds. Organic compounds always contain carbon, while most inorganic compounds do not contain carbon. Also, almost all organic compounds contain carbonhydrogen or C-H bonds. Organic chemistry is “The Chemistry of Life”. Metals in an inorganic form have significantly different chemistry in the living body from organically bound minerals.**

Response #50:

The Class III Permit Limits in Appendix B Table B-1 of the Class III Area Permit include primary drinking water standards (MCLs) and health-based standards for metals which are concentrations of a metal irrespective of its chemical bond with other elements. The exception is sulfur, which has a health advisory only for the polyatomic anion sulfate ( $\text{SO}_4^{2-}$ ).



The analytical methods in Table 8 of the Class III Area Permit detect metals on the atomic level. EPA Method 200.7 is the Determination of Metals and Trace Elements in Water and Wastes by Inductively Coupled Plasma-Atomic Emission Spectrometry (ICP-AES). EPA Method 200.8 is Determination of Trace Element in Waters and Wastes by Inductively Coupled Plasma - Mass Spectrometry (ICP-MS).

The Inductively Coupled Plasma (ICP) is an ionization source that fully decomposes a sample into its constituent elements and transforms those elements into ions. Atomic Emission Spectrometry measures emission spectra using optical spectrometry (OES). The high temperature source of an ICP-OES analytical instrument dissociates any organometallic compounds allowing it to analyze metal concentrations even in difficult organic matrices. ([ThermoFisher Scientific website](#); US EPA Method 200.7; Asendorf, S., 2020, *Lubricating oil analysis according to ASTM D5185 using the Thermo Scientific iCAP PRO XP ICP-OES*, ThermoFisher Scientific Application Note 44426.) ICP-MS analytical instruments separate out and detect elements based on mass. ICP-MS are also capable of analyzing metals in an organic matrix, with modifications to the instrument to handle organic vapor, carbon buildup and carbon-based polyatomic interferences. ([ThermoFisher Scientific Sample Preparation Notes for ICP-MS](#), AnalytickJena, 2019, *Analysis of Elemental Impurities in Naphtha by ICP-MS according to ASTM D8110-17*, Application Note-PlasmaQuant MS).

In summary, because the analytical methods specified in the Class III Area Permit for metals analyses are able to either break down any metal compounds into the separate elements or, with modifications, are able to analyze metals in an organic matrix, EPA concludes there is no need to consider the difference between inorganic and organic chemical bonds for chemical analysis of metals.

**51. Table 8 in the draft permit should more clearly specify if the analysis is to be performed for particulates or dissolved fraction. Finally, the EPA should clarify that gross alpha excludes both radon and uranium in accordance with drinking water MCLs.**

Response #51:

Table 8 in the final Class III Area Permit requires only analysis for dissolved metals and contains a footnote clarifying that gross alpha analysis is an adjusted gross alpha analysis that does not include radon and uranium.

**Reporting Spills**

**52. Page 72, Section D.11.i - Revise this section to include the following contact information for reporting oil and chemical releases to DENR. DENR Ground Water Quality Program, Spills Section, (605) 773-3296 or after hours at (605) 773-3231.**

Response #52:

EPA did not change this permit condition to require the Permittee to contact the South Dakota DENR. The permit conditions included in EPA's permits are to satisfy the requirements of the UIC program. In this case, the Class III Area Permit includes a requirement to report oil and chemical releases to EPA to assess potential endangerment to USDWs. In addition to this provision, the Class III Area Permit includes

an Endangered Species Act mitigation measure to report spills or leaks of chemicals and other pollutants to “appropriate regulatory agencies.” It is the responsibility of the Permittee to determine applicable laws and appropriate regulatory agencies it must report to.

### Clean up plan

**53. Please explain why a mill tailings pile must be sequestered forever to prevent leaching into the groundwater, yet it’s acceptable to create the same pile inside the aquifer. If groundwater is contaminated – what does the “clean-up” process entail? It’s a given that water quality will be “monitored” with what is done to clean up the mess?**

Response #53:

Conventional mining (which generates mill tailings) and in-situ recovery of uranium are completely different extraction processes and thus, are regulated differently. Mill tailings are generated by processing ore mined using conventional uranium extraction methods such as underground or open pit mining that involves excavating a volume of mineralized rock and processing that rock for uranium removal. The end result of this process is a large volume of waste rock containing residual uranium and associated metals that must be disposed of in a manner that isolates it from releasing contaminants into the environment.

In contrast, the ISR process removes uranium from the ore deposit in place (in-situ) by injecting fluids (lixiviant), which is native groundwater with oxygen and carbon dioxide added, that changes the groundwater chemistry to release uranium into the groundwater. The uranium-bearing lixiviant is pumped out of the ground by recovery wells and processed on site to extract uranium. After uranium removal, most of the spent lixiviant is pumped back to the wellfield where oxygen and carbon dioxide is added and injected back into the wellfield. This process results in the release of uranium and associated metals during ISR operations.

As explained in Response #16, EPA’s role under SDWA is not to clean up the mining aquifer, as that portion of the aquifer has been exempted from protection under SDWA. EPA’s role is to prevent endangerment to the USDWs adjacent to the mining aquifer. It is NRC’s role under UMTRCA to oversee restoration of groundwater after the uranium recovery process has been completed. Because of this required groundwater restoration by NRC, the contamination levels are much lower than those in uranium mine tailings. Therefore, any residual elevated metals concentrations in restored Class III wellfield injection intervals are not comparable to residual contamination in uranium mine tailings.

Although the Class III Area Permit does not contain any requirements for groundwater restoration, consistent with the UIC regulations, Part IV, Section D of the Permit requires the Permittee to submit a Well Closure Plan for each Class III wellfield that demonstrates there will be adequate protection of USDWs per 40 CFR § 146.10(a)(4). Section 11.0 of the Fact Sheet for the draft Class III Area Permit explains the groundwater restoration process for informational purposes only, since it is regulated under the NRC’s License and not EPA’s UIC Class III Area Permit.

The cleanup of excursions is discussed in Response #56 below.

**54. There needs to be a cleanup plan for each drilling.**

Response #54:

It is not clear what the commenter means by "each drilling." Part XI of the Class III Area Permit and Part VI of the Class V Area Permit require the Permittee to plug and abandon all injection wells in a manner that is protective of USDWs.

**Excursions**

**55. Reporting: Another concern is in 5.5.1.2.3, where it states that excursions must be reported within 24 hours but the permit allows for a delay in correction of the excursion up to 30 days. 30 days!!! This is not a minimization of contamination.**

Response #55:

This comment refers to the South Dakota Large Scale Mine Permit and is therefore outside the scope of EPA's permitting action.

**56. The problem is that the proposed corrective action required in the Class III permit is totally inadequate. Part II of the permit, section D.4.d. states that: "if wellfield pump test results indicate a possible breach in a confining unit that cannot be located for corrective action, or corrective action does not completely repair the confining zone breach, then the monitoring well system shall be designed to verify that wellfield injection interval fluids will remain within the approved injection interval per 40 CFR §144.55(b)(4)." This is the worst kind of circular logic. Furthermore, to require the Permittee to develop "operational controls" as a method of achieving the corrective action is pure non-sense. Part III on Corrective Action only deals with problems that may occur when breaches are detected during pre- operational wellfield delineation and pump testing. There is absolutely nothing in Part III on Corrective Action that states what the Permittee should do during the subsequent operational period should a problem occur in which contaminants are detected in one of the monitoring wells (either vertically in one of the confining zones or horizontally outside the authorized wellfield area). In this case, the first thing that should be required is that the Permittee must shut down the entire system and the site restoration process should begin immediately while the problem is investigated. Why aren't these simple basic requirements included in the Corrective Action section? Because any potential breach in containment would be so impactful, it must be addressed immediately.**

Response #56:

The commenter expresses concern about the fact that operational controls are an acceptable correction action method under the Class III Area Permit and states that operational controls are not adequate, but does not provide reasons why the combination of operational controls and the monitoring requirements under 40 CFR § 144.55(a)(4) are not adequate for protection of USDWs. As explained in Response #14

above, the UIC regulations do not require any specific types of corrective actions. Corrective actions are imposed in order to prevent the movement of fluids into USDWs from existing conduits of fluid movement.

EPA considered the corrective action factors in 40 CFR § 146.7, and in accordance with 40 CFR § 144.55(b)(4), EPA determined that the Permittee could use operational controls to prevent movement of fluid into USDWs. Part II, Section D.4.d of the Class III Area Permit requires the Permittee to design an adequate monitoring plan to ensure that the operational controls are effective. Part III, Section B.4. of the Class III Area Permit requires the Permittee to demonstrate that the number and placement of non-injection interval monitoring wells are capable of detecting any loss of hydraulic control in the area where features causing a breach cannot be precisely located or corrective action cannot be successfully performed and operational controls are the method of corrective action per 40 CFR § 144.55(b)(4). Part II, Section H.3.s. requires the Permittee to provide a description of any wellfield operational controls designed to contain injectate and injection interval fluids within the injection interval to address breaches in confining zones that cannot be precisely located or for which other types of corrective action cannot be performed successfully and operational controls are the method of corrective action. The description must include a narrative documenting a demonstration that the number and placement of non-injection interval monitoring wells are capable of detecting any loss of hydraulic control in that area as part of the Injection Authorization Data Package Reports EPA reviews before approving authorization to inject into a wellfield.

With regard to the commenter's second concern, it appears the commenter may not fully understand corrective action under the UIC program. Corrective action generally refers to actions that a permittee must take to mitigate any *existing* conduits of fluid movement within the area of review, such as old wells or boreholes, prior to beginning injection. Corrective action is not the mechanism to control excursions from operation of the permitted injection activity. Part IX, Section C of the Class III Area Permit contains the excursion monitoring requirements and Section 12.5 of the Fact Sheet for the draft Class III Area Permit explains the excursion monitoring requirements.

**57. Several commenters asked what would happen if contamination were detected and how quickly operations would cease. Commenters urged the EPA to describe in the permit what actions would result if contamination were detected.**

Response #57:

Part II, Section D of the Class III Area Permit has specific design requirements for wellfield monitoring systems to enable early detection of a potential excursions by monitoring groundwater levels in excursion monitoring wells before excursion parameters are detected in the monitoring wells. Part II, Section F of the Class III Area Permit requires the Permittee to demonstrate the effectiveness of wellfield monitoring systems before EPA will issue authorization to inject. The Class III Area Permit requires excursion monitoring before injection commences and continues throughout the groundwater restoration and post-restoration phases to ensure that injection zone fluids are contained and to provide information about potential for endangerment of USDWs.

Part IX, Section C of the Class III Area Permit includes wellfield excursion monitoring requirements, and Section C.4 includes monitoring requirements for a confirmed excursion. The monitoring process for identifying a potential excursion is described in Section 12.5.5 of the 2019 Fact Sheet for the draft Class III Area Permit. Section 12.5.6 discusses the monitoring requirements for a confirmed excursion. Section 12.5.8 of the Fact Sheet for the draft Class III Area Permit explains the processes available for corrective responses to an excursion. Ceasing ISR operations is not always required if the Permittee is able to control the excursion and prevent an expanding excursion plume. Corrective responses would be based on the circumstances of the event and may include: adjusting the flow rates of production and injection wells; terminating injection in the portion of the wellfield from which the excursion originated; installing pumps in injection wells to retrieve ISR solutions; plugging wells that do not pass a mechanical integrity test (MIT); and installing new pumping wells to recover ISR solutions. Part IX, Section C.4 of the Class III Area Permit requires the Permittee to remediate groundwater impacted by an excursion.

Part IX, Section C.4.g of the Class III Area Permit contains requirements related to an expanding excursion plume, where the concentrations of the excursion parameters continue to increase in impacted excursion monitoring wells or the excursion plume expands to impact additional excursion monitoring wells. Part IX, Section C.5. requires geochemical modeling of an expanding excursion plume. In the final Class III Area Permit, EPA modified the event triggering geochemical modeling of an expanding excursion plume. The requirement is unchanged for the Permittee to analyze samples from impacted monitoring wells for the larger list of water quality parameters in Table 8 upon verification of an expanding excursion plume. The new requirement is that the Permittee must compare constituent concentrations of ISR contaminants to Commission–approved background concentrations for the excursion impacted monitoring well. The requirement for the Permittee to develop a geochemical model of the expanding excursion plume is triggered if analytical results demonstrate a statistically significant increase in ISR contaminant concentrations. The geochemical model is used to track the extent of the ISR contaminants in the expanding excursion plume.

### **Concerns About Monitoring**

**58. One commenter stated that the purpose of the monitoring wells is to identify and assess impacts of ongoing uranium recovery operations and detect fluid movement out of the approved injection interval, should such an event occur and requested another ring of monitoring wells, because one set of monitoring wells is insufficient. The commenter asserted that in the nuclear industry, redundancy is always built into systems, and the same thing is needed in this permit. The commenter asserted that another ring of monitoring wells should be required to be installed outside the first ring (in the horizontal direction at least) in order to provide a second line of defense. Therefore, if and when an exceedance is detected in the first ring of monitoring wells, then it will be possible to have sufficient time to evaluate the proper course of action needed to address the situation.**

Response #58:

EPA disagrees that a second ring of monitoring wells is needed to detect horizontal excursions. The requirements under Part II, Section D provide an effective monitoring system for early detection of excursions to allow adequate time for the Permittee to implement a corrective response before ISR

contaminants cross the aquifer exemption boundary. Part IX, Section C of the Class III Area Permit excursion monitoring requirements provide adequate protection of the USDW located outside the aquifer exemption boundary. In addition, if monitoring data shows the excursion is expanding per the criteria under Section C.4.d and e, the Permittee must begin monitoring for additional water quality parameters. If ISR contaminants besides the three excursion parameters arrive at the monitoring well ring and are above Commission-approved background concentrations for that well, Section C.5 requires the Permittee to develop a geochemical model to track the extent of the expanding excursion plume. Part IX, Section C.6 requirements the Permittee to remediate excursion.

Further, should evidence of an excursion be detected, the Class III Area Permit contains provisions for increased scrutiny and excursion monitoring frequency. Specifically, Part IX, Section C.4.a and Part IX, Section E.9.a of the permit require the Permittee to notify EPA within 24 hours of a confirmed excursion. Part XII, Section D.10.e of the permit requires the Permittee to notify EPA within 24 hours of any noncompliance with a permit condition that may endanger human health or the environment. If an excursion is confirmed, Part IX, Section E.9.a of the Class III Area Permit requires the Permittee to identify the corrective response they will take to correct the excursion. As described in Section 12.5.8 of the Fact Sheet for the draft Class III Area Permit, these corrective responses would be based on the circumstances of the event and may include: adjusting the flow rates of production and injection wells; terminating injection in the portion of the wellfield from which the excursion originated; installing pumps in injection wells to retrieve ISR solutions; plugging wells that do not pass a MIT; and installing new pumping wells to recover ISR solutions for extreme cases of an uncontrolled or expanding excursion plume.

The commenter does not assert that these measures in the permit are inadequate to protect USDWs.

**59. Commenters stated that the core testing requirements included under Part II, Section G of the first draft permit should be removed and EPA should rely instead on geochemical modeling, perhaps based in part on data collected from core samples, to ensure that any residual contamination of concern, if it exists, will not harm downgradient USDWs. A proposed alternative is to conduct geochemical modeling using site specific data rather than column testing. The commenter recommended that the EPA consider the NRC's and states' approaches to this matter since they have many decades of experience successfully regulating in situ mines.**

**Related to this topic, Powertech asserted that geochemical modeling should be used rather than core testing methods such as column testing or other laboratory-scale bench testing to evaluate the potential impact of the partially oxidized groundwater down-gradient from Burdock Wellfields 6, 7 and 8 for the following reasons:**

**1. EPA appears to be focused exclusively on the attenuation capacity down-gradient of the wellfield, whereas the key for successful groundwater restoration is to demonstrate the aquifer's capacity to maintain stability within the wellfield to prevent uranium and other constituents from remobilizing. As described in Attachment A-3, EPA has concluded that geochemical modeling can be used to provide a "defensible demonstration" that these criteria are met.**

**2. Unlike column testing of core, geochemical modeling has the ability to evaluate how much oxygen will remain in the wellfield following groundwater restoration. As described on p. 197 of the Dewey-Burdock Safety Evaluation Report (SER, Exhibit 014 at 197):**

**In assessing the potential for groundwater restoration, the [NRC] staff reviewed a geochemical modeling report on the Dewey-Burdock site prepared by the USGS, under contract by the USEPA (Johnson, R. H., 2011). In its published work to date, USGS determined that the amount of oxygen remaining in the aquifer (production zone) after restoration is a key factor in stability. If some oxygen remains in the production zone, “some uranium is found in the groundwater.” If no dissolved oxygen remains then “uranium is not found in solution.”**

**3. Unlike column testing, geochemical modeling has the ability to evaluate the potential impact of reductant addition during groundwater restoration. Although Powertech’s NRC license does not currently authorize reductant addition, the license could be amended if needed to permit injection of sodium sulfide or another suitable reductant to deplete any oxygen remaining after groundwater restoration.**

**4. Unlike column testing, geochemical modeling based on site-specific data has the ability to assess how much reducing or attenuation capacity remains down-gradient from these wellfields. The fact that the uranium roll fronts have not migrated further down-gradient indicates that reducing capacity still exists.**

Response #59:

The purpose of the requirements for core collected from the injection interval aquifer downgradient of ISR wellfields and laboratory testing of core in the first draft Class III Area Permit was to evaluate the capacity of the downgradient injection interval aquifer to attenuate ISR contaminant concentrations that may remain above pre-mining concentrations after groundwater restoration. If laboratory test results did not demonstrate adequate attenuation capacity, the first draft Class III Area Permit required geochemical modeling to evaluate the potential for ISR contaminants to cross the down-gradient aquifer exemption boundary. The geochemical model was to be calibrated with laboratory and/or field data.

EPA agrees that geochemical modeling has the advantages the commenters described above over relying solely on monitoring or laboratory testing. EPA also agrees that the best way to evaluate whether groundwater restoration is successful is to demonstrate the aquifer’s capacity to maintain stability within the wellfield to prevent uranium and other constituents from remobilizing. However, because it is well documented that groundwater restoration is not able to restore all ISR contaminants back to pre-mining concentrations, it is still important to evaluate the natural attenuation capacity of the downgradient injection interval aquifer to ensure protection of USDWs.

The second draft Class III Area Permit proposed geochemical modeling as the primary method for evaluating the potential for ISR contaminants to cross the aquifer exemption boundary. Core sampling and laboratory testing are still required under the Class III Area Permit. However, permit requirements allow flexibility in the type of laboratory testing the Permittee may perform on core samples, including column testing, batch sorption testing, or other appropriate laboratory and field-testing methods to provide site-specific inputs into a geochemical model. In addition, the Permittee must calibrate the

geochemical model using analytical data from field and laboratory testing as specified in Part IV, Section B.5 of the Class III Area Permit. Similar to the requirements in the first draft Class III Area Permit, the Permittee is required to perform these tests to evaluate the capacity of the down-gradient Chilson Sandstone to remove residual contamination from restored wellfield groundwater as it travels down-gradient toward the aquifer exemption boundary. The testing and modeling evaluation must be included in the Injection Authorization Data Package Report for each wellfield to be submitted to EPA for review before EPA will authorize injection into Burdock Wellfields 6, 7 and 8.

**60. Post-restoration groundwater monitoring is no longer required. Does this include the 8 uranium mines in the area that are no longer in use?**

Response #60:

Post-restoration groundwater monitoring is still required during the stability monitoring phase to verify that the concentrations of ISR contaminants achieved through groundwater restoration will remain stable. In addition, Part IV of the Class III Area Permit requires geochemical modeling to evaluate the long-term stability of restored ISR contaminants concentrations.

The commenter does not provide details about concerns related the other uranium mines in the area. Table 16 under Part IX, Section B.3, which contains operational monitoring requirements, requires the Permittee to construct monitoring wells downgradient from the abandoned uranium mines to detect if ISR operations are causing contaminated groundwater to migrate out of the mine pools. Beyond this requirement, monitoring of any other uranium mines is outside the scope of these actions.

**61. Proposed wellfields 6, 7 and 8, located in the eastern part of the Burdock area, are very close to or on the outcrop / subcrop of the Fall River Fm. In these areas the Fall River Fm. is either partially saturated or dry. This greatly complicates the ability to hydraulically control mining fluids.**

**In addition, geochemical conditions are very different from downgradient portions of the Fall River aquifer, which complicates the ability to rely on natural attenuation to remove residual ISR contaminants. Powertech has indicated that they will not mine Fall River ore in these three wells fields – only ore in the middle and lower Chilson will be mined.**

Response #61:

EPA has extensively reviewed the hydrogeologic information in wellfields 6, 7, and 8, and agrees that the Fall River Formation either contains no groundwater or is partially saturated in this area. However, Powertech is not proposing any ISR activities in the Fall River Formation in this area.

EPA has not investigated the geochemical conditions of the Fall River Formation downgradient of Burdock Wellfields 6, 7 and 8 because, as the commenter states, Powertech has not proposed any wellfields targeting Fall River ore in this area.



**62. Another commenter requested that the EPA, not the Permittee, select the monitoring sites.**

Response #62:

EPA changed requirements from the first draft Class III and Class V Area Permits from designated sampling areas for core collection to allowing the Permittee to identify the best places to collect core samples. EPA determined that the Permittee is in the best position to determine representative locations for core samples while they are drilling the wells, because they have the most familiarity with the geological conditions at the site. The UIC regulations do not require that EPA choose the monitoring sites. Similarly, EPA changed the requirement for conducting Step Rate Tests in the Class III injection intervals at designated areas to allowing the Permittee to decide the best location for representative data. The Permittee is required to ensure that samples and measurements taken for the purpose of monitoring shall be representative of the monitored activity per 40 CFR § 144.51(j). All monitoring data is reviewed by EPA for compliance with permit requirements for demonstrating adequate characterization and representativeness of site conditions. If data do not meet these standards, EPA will require the Permittee to conduct additional monitoring.

**63. Commenters assert that monitoring is important to provide sufficient data to understand the fate and transport of contaminants or to characterize any contamination plume.**

Response #63:

EPA agrees that the results of monitoring will support an understanding of the fate and transport of contaminants. Part IV of the Class III Area Permit requires the Permittee to develop a conceptual site model (CSM) based on site-specific data that represents the geology, hydrologic properties, and geochemical characteristics and processes at the Dewey-Burdock Project to minimize uncertainty of model predictions concerning the potential for ISR contaminants to cross the aquifer exemption boundary. Groundwater samples will be collected from upgradient and downgradient of the wellfield to determine background geochemical conditions, and monitoring will be conducted within the wellfield during the post-restoration stability phase to determine geochemical conditions of the restored wellfield. In addition, core samples are required to be collected that represent aquifer mineralogy upgradient, downgradient, and within the wellfield to provide input for modeling reactions between groundwater and the aquifer solids to determine the potential for ISR contaminants to be attenuated.

**64. Several comments asserted that, by the time any contaminating fluids reach the monitoring wells at the perimeter of the proposed project, contamination may have already occurred.**

Response #64:

EPA acknowledges commenters' concerns about the contaminants migrating from a wellfield to the downgradient monitoring wells. After consideration of these concerns and others expressed in the 2017 public comment period, EPA removed the downgradient compliance boundary wells for post-restoration monitoring from the first draft Class III Area Permit and replaced those requirements with the

Conceptual Site Model and geochemical modeling requirements in the second draft Class III Area Permit. This approach will help identify the potential for a contaminant plume to occur before it happens and provides the opportunity for the Permittee to take appropriate action to prevent the plume, rather than remediate a plume that has already occurred.

There are other Class III Area Permit conditions that will prevent the contamination that the commenters raise as a concern. During operation, a significant element of monitoring at the Dewey-Burdock Project will be to ensure that the Permittee maintains an inward hydraulic gradient (as described in Section 9.2 of the Fact Sheet for the draft Class III Area Permit). This will ensure that all fluids associated with the mining operation will remain within the wellfield and, therefore, protect USDWs from migration of injected fluids. Part VIII, Section F of the Class III Area Permit requires the Permittee to maintain hydraulic control of each wellfield by ensuring that the groundwater removal in each wellfield exceeds the volume of injectate going into the wellfield. Part IX, Section C.1.a of the Class III Area Permit requires the Permittee to monitor water levels in the perimeter monitoring wells to verify the inward hydraulic gradient and monitor in the non-injection zone monitoring wells to verify vertical confinement of the injection interval. This monitoring, which includes groundwater level measurements that are recorded twice a month and no more than 14 days apart during ISR operations and every 60 days during groundwater restoration activities, will provide early warning that there may be an incipient loss of control, before an excursion plume would begin to develop.

The purpose of excursion monitoring is the early detection of incipient loss of control of injection interval fluids so that control may be regained before any contamination reaches the aquifer exemption boundary. Section 12.5.5 of the Fact Sheet for the draft Class III Area Permit describes how the permit's excursion monitoring requirements are designed to prevent large excursion plumes. Part IX, Section C.4.g of the Class III Area Permit imposes additional monitoring requirements for expanding excursion plume and Section 5 requires geochemical modeling of expanding excursion plumes to evaluate potential for contaminants to cross the aquifer exemption boundary. Part IX, Section C.6 the Class III Area Permit requires remediation of excursion plumes if they develop.

**Concern about removal of downgradient compliance boundary monitoring:**

**65. Several commenters raised concerns about removal of the downgradient compliance boundary monitoring. They stressed its importance and requested that it be reinstated. One commenter asserted that removing all down-gradient compliance boundary wells and post-restoration monitoring from this project is short-sighted and unscientific and that physical monitoring is the only way to assure that models have validity. The commenter claimed that the Dewey-Burdock site has a complex hydrogeology that is bordered by domestic and livestock wells that are in use and that water quality must be monitored, not just modeled.**

Response #65:

EPA determined that it would be more effective for the protection of USDWs to remove the down-gradient compliance boundary of monitoring wells for the post-restoration monitoring scenario proposed in the first draft Class III Area Permit and instead require development of a robust Conceptual

Site Model and geochemical modeling as proposed in the second draft Class III Area Permit. The post-restoration monitoring approach using the downgradient compliance boundary relies on the development of a contaminant plume reaching from the wellfield to the downgradient compliance boundary. The new approach focuses on identifying the potential source area for contamination inside the wellfield and allows the Permittee to focus resources on addressing the potential contamination source before the plume occurs rather than having to remediate a contaminant plume in addition to performing remedial action at the contamination source. This approach does not remove the need for physical monitoring. Part IV, Section A of the Class III Area Permit requires the Permittee to develop a robust Conceptual Site Model. This involves performing more targeted monitoring to facilitate identification of where the potential problem areas will be in the wellfield. In addition to physical monitoring, Part IV, Section C requires laboratory testing to provide additional information in identifying potential problem areas.

**66. Also, under Part 9, the six-month interval post-restoration groundwater monitoring, that also has been removed. And I believe that is also a very important part of this process and needs to be reinstated.**

Response #66:

Although the Class III Area Permit no longer contains requirements for a down-gradient compliance boundary of monitoring wells to verify that no ISR contaminants will cross the aquifer exemption boundary, post-restoration groundwater monitoring is still required under Part IX, Section B.4. The NRC License requires post-restoration stability monitoring of wellfield groundwater to verify that restored concentrations of ISR contaminants will remain stable. The Class III Area Permit requires the Permittee to evaluate the longer- term stability of restored ISR concentrations and calibrate the model using site-specific data.

**67. Removal of post-restoration monitoring requirements in the second draft Class III area permit means that contaminant plumes will reach and be consumed by nearby community members with no advance warning. People will be directly impacted, and removal of the few available means of getting advance warning is a violation of the public trust by the EPA. When the UIC wells are full and subsequently abandoned they become pressurized repositories of chemicals. Should they leak, and they inevitably do, the downgradient public will remain uninformed of toxic contaminants headed towards their wells and will likely drink the stuff to eventually find out about it. Like the removal of Minnelusa monitoring, this is a betrayal of the public trust by the EPA.**

Response #67:

During operation and groundwater restoration, the Class III Area Permit requires an inward hydraulic gradient to maintain horizontal control of injection interval fluids within Class III ISR wellfields. This results in a negative pressure gradient throughout ISR operations and groundwater restoration. As a result, the injection interval will not be over-pressured, and ISR contaminants will be contained within the wellfield until after groundwater restoration has been completed.

Furthermore, the Class III Permit requires the Permittee to demonstrate that ISR contaminants will not cross the AE boundary after wellfield closure, so downgradient users will not be impacted. Although the post-restoration line of monitoring wells proposed in the first draft Class III Area Permit are no longer required, these requirements are being replaced with requirements for geochemical modeling as described under Part IV, Section B and groundwater monitoring, core collection and laboratory testing requirements under Part IV Section C of the Class III Area Permit.

Finally, the commenter mentions removal of Minnelusa monitoring. The Minnelusa aquifer is the proposed injection zone for the Class V deep injection wells. The first draft Class V Area Permit did not require monitoring of the Minnelusa aquifer groundwater after initial sampling. Groundwater quality data from the Minnelusa aquifer at the Barker Dome oil field located approximate 4 miles northeast of the Dewey-Burdock Project Site indicates that the Minnelusa is not a USDW and therefore is not protected under the Safe Drinking Water Act. The Class V Area Permit requires initial sampling of the Minnelusa to verify it is not a USDW.

**Modeling without monitoring inadequate:**

**68. Several commenters generally objected to the use of computer modeling techniques instead of well monitoring using actual samples of water to determine whether there is migration of contaminants. The commenters expressed that there should be monitoring procedures to analyze water quality in the area before, during, and after the injection wells are used. They expressed that actual water testing is needed to determine what is actually happening and were opposed to using a mathematical model derived from a variety of other mining operations for off-site monitoring of water quality. Commenters were concerned that the model cannot account for the unpredictability of water movement through these geological strata and won't be accurate or comprehensive.**

**Finally, commenters asserted that the EPA should not rely exclusively on models for any decision or requirement in the case of such a complex, controversial project. They asserted that there should be independent analysis of any information currently left to modeling. As the EPA notes in the Cumulative Effects Analysis, "there is inherent uncertainty in the results" (p. 108) when modeling is involved.**

Response #68:

EPA agrees with commenters about the importance of monitoring and emphasizes that post-restoration monitoring has not been eliminated as a requirement of the Class III Area Permit. Rather, the CSM that the Permittee must develop under Part IV, Section A of the Class III Area Permit will support the development of a robust geochemical model to demonstrate that the concentration of each ISR contaminant will not exceed permit limits at the aquifer exemption boundary within the injection-interval aquifer. It is based on a significant set of monitoring data that will be collected from pre-ISR conditions and post-restoration stability monitoring. EPA will evaluate the Permittee's modeling efforts and results prior to authorizing injection to ensure that the model is: rigorous, representative of the site, well-documented, and based on appropriate amounts and types of data.

The Permittee must update the CSM when data gaps or uncertainty are identified concerning geology, hydrologic properties, geochemical characteristics, and/or geochemical processes that could affect mobility and transport of uranium and other metals at the Dewey-Burdock site. When this occurs, the Director may require the Permittee to collect additional data or develop alternative CSMs to accommodate and characterize the areas of uncertainty as they relate to evaluating the potential for ISR contaminants to cross the aquifer exemption boundary.

The combined modeling/monitoring approach will also support USDW protection by limiting the number of monitoring wells (i.e., artificial penetrations) that are needed to evaluate the site by supporting selection of the most relevant monitoring locations.

Once groundwater restoration has been completed, the Permittee must perform post-restoration stability monitoring, which will allow any rebounded concentrations of ISR contaminants to be detected quickly. Part IV, Section B of the Class III Area Permit lists the requirements for the development of the geochemical model. The Class III Area Permit also requires the Permittee to continue water level monitoring in wellfield perimeter monitoring wells to determine when the natural groundwater gradient has returned. See Section 15 of the Fact Sheet for the draft Class III Area Permit for additional information on the geochemical modeling approach.

Finally, commenters' reference to inherent uncertainty in modeling was in reference to the air models that Powertech conducted, not groundwater. In the case of groundwater modeling required by the Class III Area Permit, Part IV, Section B.5 and B.6 includes requirements for model calibration and uncertainty analysis. As explained in Section 15.4 of the Fact Sheet for the draft Class III Area Permit, even given the inherent uncertainty in modeling results, the Permit requirements for model calibration will make the model a more effective predictive tool, and the Permit requirements for uncertainty analysis will limit the uncertainty in model parameters and outputs so they can be characterized with confidence and prediction intervals.

**69. A) The size, complexity, and gaps in knowledge mentioned in the introduction of the Conceptual Site Model Criteria Support document are extremely understated regarding the Dewey-Burdock Site. Our incomplete understanding of the Black Hills' aquifers under current conditions inherently means dependable predictions of how the proposed mining operations will affect the aquifers and/or the interactions between them cannot be made. Until all gaps in knowledge are filled and all uncertainty about impacts of this in-situ mining project on groundwater resources are assuaged it should not be permitted.**

**B) This geochemical model is favored because it is believed that it will allow detection and addressing of lixiviant flares and ISR contaminants at the well site rather than down-gradient with higher efficacy and response time. (Class III Fact sheet pg 123). The geochemical model is a useful tool, but if groundwater restoration were to be implemented on this project it would be useful to also install the Down-Gradient monitoring wells. The purpose of these wells is to detect lixiviant that is introduced to free up toxic Uranium and ISR contaminants. These wells should be used in conjunction with the Geochemical model to detect as much as possible. One cannot stress enough the**

**importance of awareness of noncompliance and/or unnecessary contamination of our water.**

Response #69A:

EPA has reviewed information about the Black Hills geology and aquifers on a regional scale and local to the Dewey-Burdock Project Site, as reflected in responses to other comments in this document. EPA has examined the logs from many oil and gas test wells to evaluate the horizontal continuity and thickness variations in geologic strata, particularly confining zones. EPA has also examined information from private wells records to evaluate shallow aquifer information. Review of this information enabled EPA to determine that the Class III Permit Application was technically complete and that it provided enough information for EPA to develop draft permit requirements to address the hydrogeologic conditions at the Project Site and protect USDWs. Both UIC permits require extensive data collection that EPA will review before authorizing injection into the Class III and Class V injection wells. The Class III Area Permit contains extensive data collection requirements to further develop the Conceptual Site Model required under Part IV, Section A and to develop the Injection Authorization Data Package Reports required under Part II, Section H. The commenter has not identified specific concerns about the Class III Area Permit data collection or monitoring requirements.

Response #69B:

In the first draft permit, EPA included a line of down-gradient monitoring wells separate from the perimeter monitoring wells to provide the Permittee flexibility to place a line of monitoring wells *closer* to the wellfield for earlier detection of a contaminant plume emanating from the restored wellfield. As discussed in other responses, the post-restoration monitoring approach using the downgradient compliance boundary relies on the development of a contaminant plume migrating from the wellfield to the downgradient compliance boundary.

EPA's new approach focuses on identifying the potential source area for contamination inside the wellfield and allows the Permittee to focus resources on addressing the potential contamination source before the plume occurs rather than having to remediate a contaminant plume in addition to performing remedial action at the contamination source. This approach does not remove the need for physical monitoring. Part IV, Section A of the Class III Area Permit requires the Permittee to develop a robust Conceptual Site Model. This involves conducting more targeted monitoring to facilitate identification of where the potential problem areas will be in the wellfield. In addition to physical monitoring, Part IV, Section C requires laboratory testing to provide additional information in identifying potential problem areas.

**70. Contaminants will remain in the aquifer after all effects of restoration and will migrate through the aquifer into the future. Dr. Roseanna Neupauer, University of Colorado, noted that a comprehensive modeling exercise was impossible because of insufficient data of the spatial distribution of various chemical perimeters or on the chemistry of the injection solution used by the industry. Dr. Neupauer noted that diffusion of chemicals out of the immobile region can occur over many years or decades. Thus, even if the water in the mobile zone appears clean, it may become contaminated over time by this diffusive**

**process. It would further increase the concentration of lixiviant in the past -- in the post-restoration aquifer.**

Response #70:

EPA understands the commenter's concern and acknowledges that there is a potential for restored concentrations of ISR contaminants to show a rebound over time from diffusion of lixiviant constituents trapped in pores spaces. However, EPA emphasizes that this is the reason that the Class III Area Permit has requirements under Part IV, Section B.1 for the Permittee to use geochemical modeling to evaluate the restored wellfield's capacity to maintain long-term geochemical stability and to assess the downgradient portion of the exempted aquifer to attenuate residual contamination as restored groundwater flows out of the wellfield.

The commenter asserts that it is not possible to comprehensively model an ISR uranium site and references a statement by Dr. Rosemary Neupauer, University of Colorado, to support this assertion. EPA reviewed these conclusions in the 2010 report entitled *Groundwater Flow and Transport Modeling of Uranium ISL Mining*. The Natural Resources Defense Council included this report as Section VIII, Appendix B in their 2012 document entitled *Nuclear Fuel's Dirty Beginnings*. Dr. Neupauer noted "a complete simulation of the chemical evolution of the contaminated region was not possible because there was insufficient data on the spatial distribution of various chemical parameters or on the chemistry of the lixiviant" in reference to the Christensen Ranch wellfield that served as the study area for the report. This statement was not intended as a general statement that modeling of uranium ISR sites is impossible. In fact, Dr. Neupauer's report emphasizes the importance of having a robust data set available for model development.

The Class III Area Permit requires collection of a robust data set to populate the model, just as the referenced report discusses. The Permit requires development of a conceptual site model based on site-specific data for hydrologic parameters, dissolved constituents, and minerals that affect contaminant attenuation. Data must be obtained in sufficient quantity to adequately characterize both horizontal and vertical heterogeneity with respect to hydrogeology and geochemical conditions within the injection interval. Representative samples of the injectate for each wellfield also will be collected and analyzed monthly to monitor injectate chemistry. Geochemical modeling for each wellfield will be developed with site-specific data to evaluate the capacity of the downgradient exempted portion of the aquifer to attenuate any ISR contaminants remaining in the restored wellfield and the potential for subsequent contaminant rebound and transport as upgradient background groundwater flows across the wellfield. The Permit also requires that sensitivity analysis and a quantitative assessment of uncertainty be performed to identify important parameters that affect model results and to facilitate evaluation of the potential for ISR contaminants to cross the aquifer exemption boundary.

### **Specific Modeling Concerns**

- 71. One commenter asked if 3D modeling of the existing injection wells, the toxic injection wells or the toxicity plumes has been done and mentioned Vulcan or Civil 3D. The commenter recommended that this type of modeling should be done because it would be cheaper in the long run to do the modeling instead of waiting for it to be a Superfund site.**

Response #71:

EPA agrees that modeling is a useful tool for evaluating contaminant plume behavior. As Section 15 of the Fact Sheet for the draft Class III Area Permit describes, Part IV of the Class III Area Permit requires the Permittee to develop a CSM that will support the development of a robust geochemical model for predicting fluid movement and groundwater quality changes throughout the project life cycle. The CSM is a representation of the site-specific geologic, geochemical, and hydrogeologic characteristics. Permit requirements for reactive transport modeling are included in Part IV, Section B. As described, models must be calibrated to site-specific groundwater and core data described in Part IV, Section C.

Prior to receiving authorization to inject at each wellfield, the Permittee is required to demonstrate that the wellfield injection interval is hydraulically confined from overlying and underlying aquifers. Because the injection interval will be confined, 3-D modeling that includes overlying and underlying aquifers will not be necessary. The Class III Permit allows flexibility for geochemical modeling to be 3-D, 2-D, or 1-D as needed to represent conditions across wellfields at the Dewey Burdock site. If 2-D or 1-D modeling is used, the Class III Area Permit requires that enough simulations be used to represent site heterogeneity within each injection interval and flow-path variations through each wellfield based on site-specific data.

#### **Modeling Requirements Too Rigorous**

**72. The proposed geochemical model for site closure generated by the EPA in Part IV of the Revised Draft Class III Permit and represented by the five CADMUS documents far exceeds industry standards and is inconsistent with other uranium ISR operations in the USA, including Region 8. Further, the EPA/CADMUS proposal is not consistent with the NRC requirements for any other domestic uranium ISR operations. In addition, the scope of the proposed geochemical model is far beyond the Proposed Alternate Solution to Post-Restoration Groundwater Monitoring, included in Attachment A-3 of Powertech's Original EPA Letter. In its proposed alternative, Powertech envisioned two geochemical models being completed, one for each major wellfield area (i.e., one geochemical model for the Dewey area and one for the Burdock area), each generated after the successful conclusion of all ISR activities within each major wellfield area and following the NRC-approved closure of all wellfields within each major wellfield area. Powertech's proposal was designed to address the aquifer exemption boundary at each of the Dewey and Burdock areas, following the closure of the associated wellfields. Powertech envisioned the modeling effort for the Dewey and Burdock areas to be consistent with an ACL application under NRC regulations.**

**Powertech requests that the EPA remove the exhaustive geochemical modeling requirements. If the EPA insists on including geochemical modeling, despite the fact that Powertech remains unaware of any other Class III permits for uranium ISR operations in the USA, including Region 8, that require mandatory geochemical modeling, Powertech requests that the geochemical modeling be consistent with its proposed alternative and its discussion in this comment letter.**



Response #72:

The geochemical model required by the Permit is designed to predict with sufficient accuracy whether contaminants could cross the aquifer exemption boundary into the adjacent USDW and adversely affect human health. This requirement was added to the second draft permit to replace the requirement for the down-gradient line of compliance wells for use in post-restoration monitoring, in part due to comments from Powertech.

In the first draft permit issued in 2017, EPA proposed installation of a series of monitoring wells at a downgradient compliance boundary in order to ensure that contaminants would not cross the aquifer exemption boundary. Following consideration of comments received, including comments from Powertech, EPA determined that a model could provide equivalent assurance that contaminants would not cross the AE boundary, and has the advantage that it can be used to evaluate situations that cannot be monitored in the field because these situations would occur in the distant future. However, in order for the model to ensure that the injection activity can meet the prohibition of fluid movement in 40 CFR § 144.12 and substitute for physical monitoring, it needs to be populated with site-specific data and include calibration, sensitivity analysis, and quantification of uncertainty. The requirements described in Part IV of the Class III Area Permit are included to ensure best practices for geochemical modeling are followed to minimize prediction uncertainty and ensure that the injection activity can meet the prohibition of fluid movement in 40 CFR § 144.12.

While Powertech suggests that it would be adequate to require only two geochemical models, one in the Dewey area and one in the Burdock area, EPA has determined that this approach does not provide sufficient certainty concerning the potential endangerment of USDWs. Because simulations representing long-term post-restoration conditions and contaminant transport will be purely predictive and lack field-verification of results, it is important to collect sufficient site-specific data and conduct wellfield-specific modeling to minimize model prediction uncertainty. Solid-phase data presented by Johnson et al. (2013) based on core samples collected from both the Dewey and Burdock areas indicates the potential for substantial variability to occur across the site. Therefore, a single model for each major wellfield area may be insufficient to accurately simulate the potential for ISR contaminants to cross the aquifer exemption boundary. Conducting modeling after completion of each individual wellfield, rather than each major wellfield area, also enables timely recognition of potential contaminant migration issues and the collection of additional data if needed. This modeling approach also minimizes potential problems with long-term core storage and preservation because cores will need be analyzed within a shorter timeframe for each wellfield.

One of Powertech's comments appears to be that the modeling requirements exceed industry standards and is not consistent with other uranium operations in the United States, NRC requirements, or its own proposal to EPA. However, the UIC regulations do not require that EPA's permit requirements not exceed the applicant's proposal, industry standards, or NRC requirements from a different statute. The regulations require that when issuing permits, EPA ensures that USDWs are protected. This is further explained below in Response #77b.

As clarification about the role of the 5 referenced Cadmus documents, the Permit requirements were drafted by EPA, not Cadmus. The Cadmus documents referenced by Powertech in the comment were

used as a reference by EPA and are part of the administrative record as information considered by the Agency.

Finally, EPA notes that while Powertech states that EPA's geochemical modeling requirements go far beyond their proposed alternate solution in Attachment A-3 of their "Original EPA Letter," they are substantially similar to proposed specific language from Powertech in its 2017 comment table to EPA. Powertech requested that EPA include the following:

1. *Once wellfield restoration and stability monitoring have been completed in a wellfield, the Permittee shall conduct geochemical modeling using site-specific data to demonstrate that contaminants will not cross the down-gradient aquifer exemption boundary and cause a violation of any primary MCLs or otherwise adversely affect the health of persons.*
  - a. *Geochemical modeling shall evaluate the following:*
    - i. *Demonstration of the restored aquifer's capacity to maintain stability, considering the long-term influence of up-gradient groundwater.*
    - ii. *Assessment of the natural capacity of the down-gradient portion of the exempted aquifer to attenuate contaminant concentrations.*
    - iii. *Evaluation of any localized, elevated concentrations above the restoration criteria remaining in the production zone following restoration.*
  - b. *The Permittee shall submit a Closure Plan to the Director for approval describing the geochemical modeling results. The plan shall demonstrate that no ISR contaminants will cross the down-gradient aquifer exemption boundary and cause a violation of any primary MCLs or otherwise adversely affect the health of persons. The geochemical model shall be calibrated with site-specific data.*

**73. The extensive requirements described in the five CADMUS documents would constitute an expansive and cost prohibitive undertaking that would require a full-time modeling effort lasting more than a decade. These requirements have been developed outside of the context of more than 40 years of ISR operations regulated by the NRC, during which migration of ISR ore body fluids to adjacent, non-exempt aquifers has NEVER occurred. The geochemical modeling efforts described within the CADMUS documents and incorporated into the Revised Class III Draft Permit, appear to be consistent with the withdrawn, previously proposed, rules under 40 CFR Part 192. As evidenced by the EPA statements associated with the withdrawal of the proposed Part 192 rules, these proposed, extensive CADMUS requirements are unnecessary as there is already a "comprehensive and effective" regulatory framework for ISR wellfield operations, groundwater restoration and closure imposed by NRC. It is not appropriate for the EPA to develop an entirely unique approach to ISR regulation for this project for which it does not have regulatory authority.**

**The proposed, extensive CADMUS requirements effectively ignore the established protocols of the NRC, which have been successful in regulating ISR operations in the USA, including Region 8, for decades.**

**Powertech requested that EPA limit the constituents of the geochemical model to one or two constituents of concern or to those contained in an ACL application, if such is used by the applicant to satisfy NRC requirements for groundwater restoration.**

Response #73:

As explained in Response #72 above, the Cadmus documents were intended as reference documents for EPA in drafting its modeling requirements. The Cadmus documents themselves are not included as requirements in the Permit. Therefore, the commenter's characterization of the Cadmus documents as Permit requirements is not accurate.

EPA is issuing the Class III Area Permit under the Safe Drinking Water Act, not the Uranium Mill Tailings Radiation Control Act (UMTRCA). Therefore, as further explained in Response #80 below, the comments about 40 CFR part 192 are outside the scope of EPA permitting and aquifer exemption actions. The commenter provides no support for its contention that EPA has no authority to impose modeling requirements that are more stringent than those required by the NRC under UMTRCA.

The commenter suggests that because the NRC regulates this project under UMTRCA, a different statute, it is not necessary to require modeling under the SDWA to protect USDWs. However, the commenter points to nothing in the SDWA or its regulations indicating that the Permittee or EPA is relieved of obligations under the SDWA to ensure protection of USDWs due to NRC regulation of the site under UMTRCA for a different purpose.

EPA does not agree with limiting the number of constituents in geochemical models to one or two constituents of concern or to those contained in an NRC ACL application, as this would not be sufficient under the SDWA. As discussed in Response #72, EPA is requiring geochemical modeling to replace a series of monitoring wells at a downgradient compliance boundary in order to ensure that contaminants will not cross the aquifer exemption boundary. The purpose for the geochemical modeling in the Wellfield Closure Plan includes evaluating the long-term geochemical stability of the restored wellfield as well as the fate and transport of any ISR contaminants that may need ACLs. Previous geochemical modeling of restored ISR sites has indicated the potential for upgradient oxidized groundwater to overcome precipitation conditions in the wellfield and remobilize uranium, selenium, and arsenic (Davis and Curtis, 2007) or for uranium to rebound and result in concentrations greater than the MCL at the aquifer exemption boundary when oxidized conditions are present downgradient from the wellfield (Johnson and Tutu, 2016). Therefore, because of the potential for rebound, including the list of all ISR contaminants in the model is necessary to demonstrate protection of USDWs. As discussed in Response #75 below, EPA has included a list of specific constituents considered to be ISR contaminants in Appendix B, Table B-1 of the Class III Area Permit for clarity. Because the listed constituents can be included in a single model run, separate model runs would not be necessary to evaluate each constituent concentration at the aquifer exemption boundary.

While we do not agree with limiting the constituent list as suggested by Powertech, EPA has determined that the geochemical model does not need to include the fate and transport of any ISR contaminants

that did not increase in concentration above permit limits during ISR activities. Therefore, EPA added a new permit condition under Part IX, Section B.3.b that states that any ISR contaminant listed in Appendix B, Table B-1 having a concentration at or below the permit limit or the groundwater background concentration at all injection interval wells within the wellfield may be excluded from geochemical modeling described under Part IV, Section B of this Permit. If an ISR contaminant does not increase in concentration above permit limits during the injection of chemically reactive lixiviant, it will not increase in concentration above permit limits during groundwater restoration, post-restoration stability monitoring, or as upgradient groundwater flows across the restored wellfield. This means that if they are below permit limits during active injection, they will meet permit limits at the aquifer exemption boundary after the wellfield has been restored.

**74. The Revised Draft Class III Permit fails to fully recognize the current standards and regulations for groundwater restoration.**

Response #74:

The commenter raises concern that the Class III Area Permit does not recognize the groundwater restoration standards under a different statute, UMTRCA. While EPA is aware of those standards, they are outside the scope of the SDWA and the UIC regulations. As explained in Response #16 above, the SDWA does not protect the portion of the aquifer exempted for mining. However, the water quality of the exempted portion of the aquifer is relevant to the issue of whether contaminants can cross the aquifer exemption boundary into the adjacent USDW.

**75. The Revised Draft Class III Permit contains no specific standards or requirements for successful data collection or closure with a geochemical model.**

Response #75:

Acceptance criteria for the CSM are presented in Part IV, Section A.3 of the Class III Area Permit. This section has been revised to clarify: 1) the CSM shall be based on site-specific data as specified in Part IV, Section C – Monitoring, Laboratory Testing, and Field Investigations for Geochemical Model Calibration Using Site-Specific Data; 2) aqueous geochemical data shall be collected according to applicable procedures described in Part IX, Section A – General Monitoring Requirements; and 3) groundwater samples shall be analyzed for the analytes and parameters listed in Table 8 using the specified analytical method or equivalent method with Director’s approval. In addition, Part IV, Section A, has been updated to clarify that the CSMs developed for wellfields other than wellfields 6, 7, and 8 are not required for the Injection Authorization Data Package Reports unless site-specific data indicate oxidizing conditions downgradient from the wellfield. This section also indicates that the CSM will become part of the Wellfield Closure Plan for all ISR wellfields. Section A.4 lists conditions that trigger the need to update the CSM with new data. The final test of successful data collection is when there are no data gaps are discovered during development of the geochemical model and there is adequate data coverage for model calibration and predictive simulations.

The standard for a successful closure plan is an accurate evaluation of the stability of restored concentrations of ISR contaminants over time while upgradient groundwater flows through the restored wellfield and evaluation of the downgradient natural attenuation of any elevated concentrations of ISR contaminants such that no ISR contaminants will exceed MCLs, Health-Based Standards or background concentrations of the ISR contaminants list is Table B-1 in Appendix B of the Class III Area Permit. Part IV, Section D.2 of the Class III Area Permit has been revised to more clearly indicate the documentation and acceptance criteria for wellfield closure. In particular, the section has been revised to indicate that model results must demonstrate that the concentration of each ISR contaminant will at no time exceed the permit limit or the background groundwater concentration, whichever is greater, at the aquifer exemption boundary within the injection-interval aquifer.

### **Modeling Requirements Too Vague**

**76. Many of the geochemical modeling requirements proposed by the EPA remain vague and unspecified, and the results that must be demonstrated for successful closure by EPA are unclear. Many of the proposed requirements contain open-ended wording, which creates ambiguity to the extent which the EPA could implement actual requirements after issuance of the permit. This is further compounded by the fact that many of the supporting documents for the geochemical model make use and reference the no-longer applicable March 2017 draft Class III permit requirements and the withdrawn, previously proposed, 40 CFR Part 192 rulemaking. Even more concerning is that an expansive geochemical model was a specific requirement of the withdrawn 40 CFR Part 192 rulemaking (see Powertech's Original EPA Letter, comment G-5).**

Response #76:

The Class III Area Permit has been revised in several places to provide additional clarity. The Permit now specifies that wellfield closure is contingent upon the successful demonstration through geochemical modeling that the concentration of each ISR contaminant will at no time exceed the permit limit or the background groundwater concentration, whichever is greater, at the aquifer exemption boundary within the injection-interval aquifer. A table listing specific analytes considered to be ISR contaminants has been added. Portions of text in Part IV of the Permit has also been revised to clarify requirements for development of a CSM and for geochemical modeling in response to detailed comments provided in Table 1 of Powertech's letter to EPA dated December 9, 2019.

The modeling requirements described in Part IV of the Class III Area Permit are not included to address requirements of the withdrawn 40 CFR Part 192 Rulemaking. Rather, they are included to ensure best practices for geochemical modeling are followed to minimize prediction uncertainty concerning the potential for ISR contaminants to cross the aquifer exemption boundary. As explained above in Response #72, the requirements in the permit are necessary to ensure that contaminants will not cross the AE boundary. EPA has an obligation under 40 CFR § 144.52(a)(9) to tailor permit conditions on a case-by-case basis to prevent fluid movement to USDWs. EPA finds it necessary to include these geochemical modeling and data collection requirements in the Class III Area Permit because this approach serves as a replacement for the down-gradient line of compliance wells for use in post-restoration monitoring for each wellfield. EPA's intent was to list criteria that represent state of the art

science for geochemical modeling. EPA attempted to strike a balance between completeness of criteria for the Permittee to consider and implement and flexibility to allow the Permittee to consider and use criteria that are appropriate for a given situation. The intent is to not be so restrictive as to require implementation of criteria that are not appropriate for a situation. The geochemical model required by the Permit is designed to predict with sufficient accuracy whether contaminants could cross the aquifer exemption boundary into the adjacent USDW and adversely affect human health.

### **Standards too Stringent**

**77. Several commenters raised concerns that permit conditions not used in prior uranium ISR permits are unwarranted. The permit conditions include monitoring requirements for excursions and expanding excursion plume, corrective action requirements, additional analytes on the water quality parameter list, some requirements for the conceptual site model and geochemical modeling. They asserted that these requirements are unwarranted for the following reasons:**

- a. They are unprecedented and are not required for other uranium operations in the United States and are a significant departure from previous EPA Region 8, Underground Injection Control (UIC) Program reviews and approvals for ISR aquifer exemptions in adjacent Wyoming;**
- b. They are arbitrary, capricious, and not supported by the governing statutes, existing regulations, or long-standing agency guidance;**
- c. EPA has not provided any scientific or factual justification for the imposition of these new unwarranted and costly requirements and both the NRC and the State of Texas have publicly stated after extensive investigation that no off-site underground sources of drinking water have ever been contaminated by ISR mining of uranium. Instead of providing any scientific evidence to support the need for additional regulations, EPA engages in speculation by suggesting that “the lack of data does not demonstrate that no contamination is occurring, as industry commenters assert, but instead merely demonstrates the lack of data available to be able to make such a determination, especially here there has been limited post-restoration monitoring.” 82 Fed. Reg. at 7404. EPA offers no evidence that impacts have occurred at other ISR facilities as a basis for the proposed post-restoration groundwater monitoring, column testing and additional excursion monitoring and corrective action requirements. Accordingly, those proposed conditions are wholly unsupported and should be deleted.**
- d. The proposed additional permit requirements are not based on any final rulemaking, which would be the appropriate venue to change the way that the U.S. ISR industry is regulated. Since EPA does not cite any site-specific concerns with the Dewey-Burdock Project as the basis for the proposed additional permit requirements, Powertech must conclude that EPA has determined that these additional monitoring requirements are appropriate for the ISR industry generally.**
- e. They are operationally and financially burdensome and would subject Powertech to a substantial economic and competitive disadvantage.**

Response #77:

- a. Permit decisions are based on site-specific information, and permit conditions are not limited by permit conditions at other uranium operations. Permit conditions are written to ensure protection of USDWs based on factors at that location. The commenters do not cite to a statutory provision or regulation limiting permit conditions to those previously used in other UIC permits.

The commenters confuse EPA's approval of aquifer exemptions in Wyoming with permits issued by the State of Wyoming for in-situ recovery of uranium. EPA approvals of state aquifer exemptions are based solely on the regulatory criteria at 40 CFR § 146.4. They are independent of associated permit decisions. EPA's approval of an aquifer exemption is not an endorsement or approval (either explicit or implicit) of the associated permitted activity. EPA has no direct role in the issuance of state UIC permits.

- b. The Class III Permit conditions of concern, including monitoring, corrective action, and modeling, are included in the Permit to protect USDWs adjacent to the mining aquifer. The UIC regulations mandate that the operator:

“shall not construct, operate, maintain, convert, plug, abandon, or conduct any other injection activity in a manner that allows the movement of fluid containing any contaminant into underground sources of drinking water, if the presence of that contaminant may cause a violation of any primary drinking water regulation under 40 CFR part [141] or may otherwise adversely affect the health of persons. The applicant for a permit shall have the burden of showing that the requirements of this paragraph are met.”

40 CFR § 144.12(a). The UIC program is preventative, and the regulations were promulgated for the purpose of preventing contamination of USDWs. Thus, EPA's role in issuing permits is to assure that the UIC regulations are met and that a permit can be written to ensure injection activities do not endanger USDWs. Contrary to the commenters' assertions that the permits conditions are arbitrary, capricious, or not supported by the statute or regulations, the UIC regulations include specific monitoring requirements (40 CFR §§ 144.51, 144.52, 144.54, 146.10, 146.32, and 146.33) and specific corrective action requirements (40 CFR §§ 144.52, 144.55, 146.7 and 146.34). In addition to these requirements, the UIC regulations require the Director of a UIC program to “impose on a case-by-case basis such additional conditions as are necessary to prevent the migration of fluids into underground sources of drinking water” and “establish conditions in permits as required on a case-by-case basis, to provide for and assure compliance with all applicable requirements of the SDWA and parts 144, 145, 146 and 124.” 40 CFR §§ 144.52(a)(9) and (b)(1). These provisions provide ample authority for the conditions that commenters have concerns about. Commenters do not articulate why they believe the conditions are arbitrary and capricious and unsupported by the SDWA.

- c. As explained in Response #77a above, permit decisions are site-specific and are made by the director of the appropriate UIC program following extensive review of the information from the applicant, the public, and other sources. EPA's charge in writing permits is to ensure that the injection activity can occur without endangering USDWs. In the comments presented, the commenters do not articulate specific concerns about the permit conditions and assert only that they are unwarranted because they have not been used in other projects in the past and that EPA

must justify the use of any new permit conditions. Therefore, EPA is unable to provide a specific response. However, on the general issue raised, EPA is not limited to only using permit conditions that have been used in the past.

Commenters assert that the NRC and Texas have both stated that no off-site underground sources of drinking water have ever been contaminated by ISR mining of uranium. However, other commenters have cited to reports that indicate there has been evidence of such contamination occurring in Texas. After consideration of these reports and the site-specific information before the agency, EPA determined that the best way to ensure that adjacent USDWs are not contaminated is to require modeling and monitoring that demonstrates this will not occur. This is explained in Response #72 above. While commenters argue that the burden is on EPA to justify why these requirements are necessary, the regulations specify that the burden is on the applicant to show that USDWs will not be contaminated. See 40 CFR § 144.12.

- d. As explained above in Response #77b, EPA has the authority and the obligation to include monitoring and corrective action requirements and any other conditions necessary to prevent the migration of fluids into adjacent USDWs. Therefore, additional regulations and rulemaking are not necessary.

The UIC permitting process is a site-specific process. Each permit review requires EPA to consider the site-specific information submitted by the applicant to determine whether injection can occur without endangering USDWs; permit conditions are written based on that site-specific information and ensure that the injection occurs in a way that meets statutory and regulatory requirements that protect USDWs. As explained in Response #77b above, EPA has authority to impose permit conditions under the UIC regulations. This authority does not require EPA to engage in rulemaking to impose permit conditions. On the contrary, the regulations include a requirement that EPA impose “on a case-by-case basis such additional conditions as are necessary to prevent the migration of fluids into underground sources of drinking water.” 40 CFR § 144.52(a)(9).

- e. In determining necessary conditions to protect USDWs, EPA must look to the UIC regulations. These regulations do not provide authority to EPA to relax the standard to protect USDWs due to financial burden or competitive disadvantage for the permittee.

**78. The NRC staff prepared the Supplemental Environmental Impact Statement (SEIS) for the Dewey-Burdock Project, which evaluated potential impacts to groundwater outside of the exempted aquifer (Exhibit 008). As noted on page 5 of the Draft Cumulative Effects Analysis, EPA reviewed the draft and final NRC SEIS. However, at no time did EPA comment that the groundwater protection measures required by NRC were insufficient to protect groundwater outside of the exempted aquifer.**

Response #78:

The commenter appears to conflate EPA’s role under Clean Air Act section 309 to review NEPA documents issued by other agencies with EPA’s separate role to issue UIC permits under the Safe Drinking Water Act. These are entirely separate duties under different statutes. The UIC regulations do not limit EPA’s authority and obligation to protect USDWs based upon comments or a lack thereof



regarding another agency's licensing process. As stated in other responses in this document, the Nuclear Regulatory Commission's process under UMTRCA is outside the scope of EPA's permitting and aquifer exemption actions.

**79. EPA received comments that the following specific permit requirements were unwarranted:**

- **Conduct post-restoration groundwater monitoring for each wellfield after the Nuclear Regulatory Commission (NRC) approval that groundwater restoration has been successfully completed**
- **Install a new down-gradient compliance boundary monitoring well network for each wellfield inside of that currently required by NRC license requirements and quarterly sampling to determine initial baseline values**
- **Part IV of the draft permit includes a requirement to install a Down-Gradient Compliance Boundary. The Down-Gradient Compliance Boundary is an additional string of monitor wells located between the production area and the monitor well ring. To this unjustified requirement, for installation of an additional set of monitoring wells, the EPA has attached an entirely new set of baseline monitoring, excursion monitoring, a new and separate point of compliance, and therefore an additional set of restoration requirements; all of which is completely duplicative and overlapping with the NRC license and Commission decisions**
- **Collect core samples prior to operations, storing these for years and then testing these in "pass/fail" laboratory column tests, where a single constituent measured above background concentration would signal a failed test**
- **Quarterly groundwater sampling from the DGCB monitoring wells to establish initial baseline values before injection begins in the wellfield**

Response #79:

Requirements to install down-gradient compliance boundary monitoring well networks and conduct post-restoration groundwater monitoring at the down-gradient compliance boundary were removed from the 2019 draft Class III Area Permit. The very specific core collection requirements in the Class III Area Permit were removed from the second draft permit. These requirements were replaced by requirements now found under Part IV, Section C. For additional explanation of these changes, please see *Changes to the Class III Area Permit* items #63 and #66. Therefore, the concerns about these requirements are moot.

**80. Commenters stated that "the Uranium Mill Tailings Radiation Control Act (UMTRCA) grants EPA the authority to promulgate generally applicable standards (not regulation). The NRC then enacts and enforces regulations to conform to the generally applicable standards. The requirements in Part IV and Part IX of this draft, which are provided for under the guise of 40 CFR § 144.33, not only overlap the NRC regulations but exceed the EPA's authority under UMTRCA." The commenters further expressed the concern that EPA appeared to be attempting to apply similar standards to those included in a proposed rule**

**issued by the EPA in January 2017 – Health and Environmental Protection Standards for Uranium and Thorium Mill Tailings (82 FR 7400), that was withdrawn. EPA has no authority to place additional requirements extending beyond those established in the cited regulation.**

Response #80:

EPA's authority to impose permit conditions comes from the Safe Drinking Water Act (SDWA) and the Underground Injection Control (UIC) regulations found at 40 CFR parts 144 to 148, not from the Uranium Mill Tailings Radiation Control Act (UMTRCA). The purpose of the SDWA is distinct from the purpose of the UMTRCA. The SDWA UIC program is a preventive program that protects underground sources of drinking water (USDWs) from contamination by underground injection. At the Dewey-Burdock project site, the mining area is exempted from the definition of a USDW under an aquifer exemption action. However, the USDWs surrounding the exempted aquifer continues to be protected under the SDWA. When issuing permits, EPA's role is to ensure that USDWs are protected from contamination. The monitoring and testing requirements that the commenters object to are designed to detect potential contamination that may endanger the surrounding USDWs. As explained in Response #77b above, there are several UIC regulations authorizing the EPA to set these types of permit conditions; they are not found at 40 CFR § 144.33, as the commenters assert. The area permit authority at 40 CFR § 144.33 authorizes EPA to use its discretion to allow for permits to be written on an area-wide basis rather than on an individual basis. It does not include a detailed description of permit conditions to be written into area permits nor does it limit the authority of EPA to set permit conditions.

The comments about the scope of EPA's authority under UMTRCA are not relevant to and fall outside the scope of these SDWA permitting and AE actions before us.

**81. Several commenters asserted that the EPA should not duplicate or conflict with regulation by the NRC, saying that it is unnecessary, inefficient, or that EPA does not have authority to regulate areas regulated by the NRC. Areas of regulation that commenters specifically stated were either duplicative or conflicting are: excursion monitoring within the exempted aquifer, wellfield monitoring programs, stock and domestic well monitoring.**

**Powertech requested that EPA leave all matters of excursion and control to the NRC. Therefore, it asked that EPA remove a number of monitoring requirements because they are inconsistent or duplicative with NRC's monitoring requirements.**

Response #81:

The Class III UIC permit is being issued under the SDWA, which has specific regulatory requirements for in situ production of uranium and other minerals for the prevention of endangerment to USDWs from the injection activity. This includes specific requirements for monitoring provisions in a Class III permit. The UIC regulations do not allow for these monitoring requirements to be omitted or waived because another federal agency has its own monitoring requirements under a different statute. If EPA did not include these monitoring provisions in the UIC permit, it could not ensure that USDWs would be protected under the SDWA and therefore could not issue the permit.

Commenters do not articulate why they believe EPA does not have authority to regulate an in-situ leach uranium operation under the SDWA when the NRC regulates in a different role at the project site. It is not uncommon for more than one agency to have regulatory authority over a project. In such a situation, the regulated entity would be obligated to meet all applicable requirements of all applicable statutes.

EPA worked to ensure that any overlap in regulation did not cause any conflicts for Powertech. EPA does not agree that there is a conflict when one agency had a more stringent standard than the other. In these cases, Powertech would need to meet the more stringent standard so that it would meet requirements in both statutes. A true conflict would only arise if one agency's requirements resulted in noncompliance with the other agency's requirements.

**82. The proposed draft permit is fundamentally flawed because it is based on speculation about potentially existing but completely unobserved and unproven effects rather than “the best available peer-reviewed science and economics.” Accordingly, many of the proposed permit conditions would unnecessarily burden the recovery of uranium essential to the use of nuclear energy in the United States by curtailing and imposing significant costs on the permitting and operation of uranium ISR projects essential to the utilization of nuclear energy resources. The imposition of such requirements contravenes the essence of energy and regulatory policies embedded in Executive Order 13783 “Promoting Energy Independence and Economic Growth” (March 28, 2017); Executive Order 13777 “Enforcing the Regulatory Reform Agenda” (February 24, 2017); and Executive Order 13771 “Reducing Regulation and Controlling Regulatory Costs” (January 30, 2017).**

Response #82:

As explained in Response #77e above, EPA must look to the UIC regulations to establish permit conditions. These regulations do not provide authority to EPA to relax the standard to protect USDWs or waive requirements due to economic burden. The Executive Orders cited by the commenter also do not provide authority for EPA to waive UIC regulatory requirements due to economic burden.

#### **Concern About 40 CFR § 144.12**

**83. Part IX, Section E of EPA’s draft permit also addresses ‘post-restoration’ monitoring, indicating it is required to demonstrate no ISR contaminates cross the aquifer exemption boundary into the surrounding USDW’s at a concentration above the baseline water quality limits of the USDW outside the aquifer. Again, this monitoring is outside current approved regulation. Interestingly, the monitoring requirements appear to be an application of 40 CFR §144.12(b), even though it isn’t cited in the document, and it has been misinterpreted and therefore misapplied. 40 CFR §144.12(b) actually states:**

**“...if any water quality monitoring of an underground source of drinking water indicates the movement of any contaminant into the underground source of drinking water, except**

as authorized under part 146, the Director shall prescribe such additional requirements for construction, corrective action, operation, monitoring, or reporting (including closure of the injection well) as are necessary to prevent such movement. In the case of wells authorized by permit, these additional requirements shall be imposed by modifying the permit in accordance with §144.39, or the permit may be terminated under §144.40. If cause exists, or appropriate enforcement action may be taken if the permit has been violated.”

40 CFR §144.12(b) indicates that modifying a permit to include additional monitoring is done only as a consequence of negative monitoring results for a USDW outside of the aquifer exemption; whereas, EPA is requiring all of the additional monitoring at the start of mining. It is obvious this regulation, as written, has a specific course of action by which negative results must be demonstrated, which then triggers a consequence and/or corrective action (i.e. additional monitoring). For the EPA to “pre-impose” a regulation without cause, thus adding exorbitant costs to a start-up project, is inappropriate.

Response #83:

The post-restoration monitoring permit condition raised in this comment was in the first draft and was removed in the second draft and replaced with the requirements for development of conceptual site models and geochemical modeling to demonstrate the ISR contaminants will not cross the AE boundary above the permit limits required in Appendix B, Table B-1. Therefore, this comment is moot.

EPA would like to clarify any misunderstanding about EPA’s authority to impose monitoring. As explained in Response #77b above, EPA’s authority to impose monitoring requirements via permit can be found at 40 CFR §§ 144.51, 144.52, 144.54, 146.32, and 146.33. The prohibition of fluid movement standard at 40 CFR § 144.12(a) and (b) provides the non-endangerment standards that an owner or operator must meet. The UIC program is *preventive*. There does not need to be contamination of a USDW in order for EPA to be able to act. This is made clear throughout the UIC regulations, the SDWA, and its legislative history. Please see, for example, 40 CFR § 144.52(a)(9), which states that “[t]he Director shall impose on a case-by-case basis such additional conditions as are necessary to prevent the migration of fluids into underground sources of drinking water.” (Emphasis added).

**84. A number of commenters expressed concern about the non-endangerment standard in the SDWA and how the EPA is applying it in this case. One commenter asserted that EPA’s non-endangerment standard of the SDWA prohibits fluid movement from injection only insofar as it would cause a failure of a public water system to comply with health-based limits for contaminants. A handful of other commenters expressed that contaminant is defined too broadly and that the SDWA only intended to prevent “endangering” contaminants from migrating into USDWs.**

Response #84:

The SDWA endangerment standard states that:

“[u]nderground injection endangers drinking water sources if such injection may result in the presence in underground water which supplies or can reasonably be expected to supply any public water system of any contaminant, and if the presence of such contaminant may result in such system’s not complying with any national primary drinking water regulations or may otherwise adversely affect the health of persons. “

42 USC § 300(h)(d)(2). As explained above in Response #77, the SDWA is a preventive program. It does not require that contamination will cause a specific public water system to fail to comply with a health-based limit. Congress intended to protect USDWs of sufficient quality such that they could potentially supply *any* public water system.

The non-endangerment standard is further defined at 40 CFR § 144.12. This regulation specifies that owners/operators cannot conduct any injection activity that allows movement of a fluid containing any contaminant into underground sources of drinking water, if the presence of that contaminant may cause a violation of any primary drinking water regulation under 40 CFR part 141 or may otherwise adversely affect the health of persons. The applicant for a permit shall have the burden of showing that the requirements of this paragraph are met. See 40 CFR § 144.12(a). “Contaminant” is broadly defined in the regulations as “any physical, chemical, biological, or radiological substance or matter in water.”

For Classes I, II, III and VI wells, 144.12(b) explains that non-endangerment is met via a “no migration” standard: if any water quality monitoring of an USDW indicates the movement of any contaminant into the underground source of drinking water, except as authorized under part 146, the Director shall prescribe such additional requirements for construction, corrective action, operation, monitoring, or reporting as are necessary to prevent such movement.

For Class III wells, this “no migration” standard was modified shortly after promulgation. The Federal Register preamble to EPA’s proposed changes of the “no migration” standard for purposes of Class III operations explained that the “no migration” standard is achievable during operations. 46 Fed. Reg. 48243, 48246-7 (October 1, 1981). However, the preamble went on to say that litigants pointed out that following abandonment of some Class III wells, “a ‘no migration’ standard may not be technically or economically feasible to achieve in the case of at least some abandoned Class III sites. It may be extremely difficult to remove all residues of the mining activity, for example, ammonia, from the mining site. As the natural flow of the aquifer is reestablished after abandonment, such residues may be dissolved or eluted over time and carried into protected portions of the aquifer.” *Id.*

As a result of this concern, the agency determined that for purposes of plugging and abandonment of Class III wells, it would be appropriate to provide Directors the flexibility to determine the “appropriate level of protection” in each individual case. It did so by amending the regulations to say that “the plugging and abandonment plan required in 40 CFR 144.51(o) and 144.52(a)(6) shall, in the case of a Class III project which underlies or is in an aquifer which has been exempted under 146.04, also demonstrate adequate protection of USDWs.” 40 CFR § 146.10(a)(4).

The preamble to this proposed language explains that “the ‘adequate protection’ standard is intended to require all efforts on the part of the operator that are necessary to assure that there will be no movement of fluids into an underground source of drinking water so as to create a significant risk to the health of persons.” 46 Fed. Reg. at 48246-7. “EPA expects the Director to take the particular circumstances of the mining site into account – for example, the nature and concentration of the

residuals, the hydrogeology of the aquifer, the economic and technical feasibility of cleanup actions, the importance of the aquifer, the proximity of water wells, and the number of people relying on the USDW down-gradient from the mining site.” Id.

Following consideration of the circumstances in this case, EPA determined that “adequate protection” means that no constituents that have a maximum contaminant level (MCL) under the Safe Drinking Water Act or other health-based standard can exceed that concentration at the aquifer exemption boundary, unless the native groundwater background concentration naturally exceeds that limit. Sulfate is an example of one of these constituents. Part II, Section E.2.b.iv and v of the Class III Area Permit now contains requirements for how the Permittee is to determine the background groundwater concentration downgradient from ISR wellfields for constituents with background concentrations above the permit limit. Health-based standards are for constituents that do not have MCLs but could adversely affect human health. The standards EPA is setting as permit limits to ensure there is not a risk to human health are now included in Table B-1 of Appendix B to the Class III Area Permit. Part IV, Section B of the Class III Area Permit requires the Permittee to conduct reactive transport geochemical modeling to evaluate the potential for ISR contaminants to cross the aquifer exemption boundary. Modeling must demonstrate that the concentration of each ISR contaminant will at no time exceed the permit limit in Appendix B, Table B-1 or the background groundwater concentration, whichever is greater, at the aquifer exemption boundary within the injection-interval aquifer. Modeling results will become part of the Wellfield Closure Plan for all ISR wellfields.

**85. §144.12(a) is important because of its relationship with 40 CFR § 142 and should be cited in the draft permit document. 40 CFR §142 not only includes the national drinking water standards but also the application of MCL’s that must be considered when applying the standard, “may otherwise adversely affect the health of persons.” EPA’s misinterpretation gives the appearance of selectively applying regulation by only allowing baseline as the criteria and disallowing the use of MCL’s which form the standard used for protection of human health.**

Response #85:

EPA agrees that 40 CFR § 144.12(a) is an important regulation. The language from this regulation is incorporated into the Class III area permit in Part I, Effect of Permit. EPA believes the commenter is referring to consideration of contaminants that *either* exceed National Primary Drinking Water Standards in 40 CFR part 141, or “may otherwise adversely affect the health of persons.” EPA has considered both of these types of contaminant standards in drafting the permits. As explained in Response #21 above, EPA is requiring determination of background concentrations only for constituents in Appendix B Table B-1 for which background concentrations in the native groundwater of the Inyan Kara aquifers naturally exceed the permit limits listed in Table B-1. In addition, EPA clarifies that the permit limits at the aquifer exemption boundary are MCLs or other health-based standards, unless the background concentration for a constituent is above the permit limit.

Part II, Sections E.2.b.iv and v are the requirements for the determination of background concentrations of ISR constituents and provide the information to the Director for review and approval.

As discussed in this Response to Comment in several responses above, Part IV, Section B of the Class III Area Permit states that the Permittee shall conduct reactive transport geochemical modeling to evaluate the potential for ISR contaminants to cross the aquifer exemption boundary. Constituents considered to be ISR contaminants under this Area Permit are listed in Appendix B, Table B-1. Modeling shall demonstrate that the concentration of each ISR contaminant will at no time exceed the permit limit or the background groundwater concentration, whichever is greater, at the aquifer exemption boundary within the injection-interval aquifer. Modeling results will become part of the Wellfield Closure Plan for all ISR wellfields.

#### **Specific Class III Permit Comments from Powertech not Addressed in Other Responses**

- 86. Part VI, Section A. Requirements for Well Stimulation, Workovers and Alterations - Powertech requests removal of the requirement to demonstrate that the integrity of cement above the well screen or open hole has not been compromised by exposure to the acid if an acidizing operation is conducted on well perforations. Only a small volume of acid would be used for well stimulations. The acid largely would be consumed by precipitates and natural formation buffering. In addition, fluid flow in the injection interval is horizontal not vertical. Lastly traditional mechanical integrity testing methods to examine the condition of the cement above the well screen cannot be conducted on wells with PVC casing.**

Response #86:

EPA agrees with this comment and has removed this requirement from the Class III Area Permit. EPA originally included this requirement because it is a standard requirement in Region 8 UIC Program Class II permits. Class II injection wells are used to inject fluids produced during oil production, which are usually brines high in total dissolved solids (TDS). The Class III wells at the Dewey-Burdock site will not be injecting fluids with high enough TDS to cause a rapid buildup of mineralization at the well screen. The typical life span of a Class III uranium ISR injection well is probably not long enough for the well screen to acquire mineralized deposits or bacterial buildup large enough to occlude the well screen. If well screens do need to be acidized, with their short life span, these Class III wells will not be subjected to acidizing jobs frequently enough to compromise the cement at the base of the well casing to the point that a breach through the confining zone would occur. EPA agrees with Powertech's reasons why an acidizing operation would not compromise the cement. EPA also agrees that there is not an EPA-approved mechanical integrity test available for testing the external mechanical integrity of a PVC-cased injection well. EPA concludes that removing this requirement from the Class III Area Permit will not endanger overlying USDWs.

- 87. For requirement Part IX, Section B.3.a Operational Monitoring of Domestic Wells, Powertech requests revising "quarterly" to "annually" for consistency with Section 5.7.8.2 of the approved NRC license application**

Response #87:

The second draft UIC Class III Permit required sampling of three domestic wells on a quarterly basis and analyzing the samples for the list of water quality analytes in Table 8. The domestic wells are located downgradient from the Project Boundary. After further communication with NRC and additional review of its documents, EPA understands that its license requires annual operational monitoring of the domestic wells for the 34 NRC analytes.

As explained in Responses # 80 and #81 above, there is no requirement that EPA's Permits be consistent with the NRC license, as they are issued under different statutes for differing purposes. However, EPA is making changes to this monitoring requirement because the purpose for the monitoring of these three downgradient domestic wells is to determine whether they have been impacted by the upgradient ISR activities, not to acquire data for the geochemical model. EPA recognizes that this determination can be accomplished by analyzing groundwater samples for only the three excursion parameters during quarterly sampling events. As discussed in Response #22 above, the Class III Area Permit now requires analysis of the annual sample for only the 34 NRC analytes, rather than the longer list of EPA analytes in Table 8. Because the domestic wells are located downgradient from the Project Boundary, the geochemical model required by the Class III Area Permit will not include these three wells. Therefore, the additional analytes not included on the NRC list are not needed for these analyses. If a quarterly sample shows the concentrations of any of the excursion indicators are elevated at a well, then a follow-up sample will be collected and analyzed for the 34 NRC analytes.

**88. 24 hour Reporting Table H - Powertech requests removal of the requirement to report within 24 hours: "Any noncompliance which may endanger human health or the environment, including: Any monitoring or other information which indicates that any contaminant may cause endangerment to a USDW; or Any noncompliance with a permit condition or malfunction of the injection system which may cause fluid migration into or between USDWs." Powertech requested removal of this provision because they assert it is inconsistent with NRC license requirements, excessive, and unclear.**

Response #88:

EPA cannot remove this requirement from the permit because this provision is required by regulation to be included in all UIC permits, either expressly or incorporated by reference. This requirement can be found at 40 CFR §144.51(l)(6).

**89. Remove the requirement under Part IV, Section A.1.a.vii. to include information about grain size, cementation, overgrowths, and nodules from the list of petrological and mineralogic characteristic that can affect hydraulic and geochemical properties of the injection interval and confining zones. This requirement is inconsistent with NRC license requirements. The overall hydraulic properties will be measured by the pump test and thus more representative of these properties.**



Response #89:

As explained in Responses #80 and #81 above, EPA's permit conditions must meet requirements under the Safe Drinking Water Act, which has a different purpose than UMTRCA, the statute under which the NRC issued its license. While the Class III Area Permit requirements may obligate Powertech to provide EPA more information than what is being required under the NRC license, they do not conflict with it, as explained in Response #80 and #81. The information referenced by the commenter is being required because it is necessary in order to complete the conceptual site model that supports the geochemical model.

Because results of reactive transport modeling are sensitive to geochemical input parameters, the Class III Area Permit requires site-specific characterization of aquifer geochemistry, including characterization of solid-phase geochemistry shall include properties. This information is available from examination of thin sections taken from core samples. EPA has not omitted this information from the Class III Area Permit; however, this requirement has been moved to Part IV, Part A.2.c to clarify that EPA needs this information as it relates to chemical characteristics of the solid phase rather than hydraulic properties of the aquifer. EPA agrees that hydraulic properties will be measured by the pump test.

**90. Remove the requirement under Part IV, Section A.1.b.i and ii and A.1.c to provide the following hydrologic property information for the CSM for each wellfield injection interval and the first confining zones overlying and underlying the injection interval: Porosity; Intrinsic permeability (horizontal and vertical); Vertical hydraulic conductivity; Transient hydraulic-head conditions during injection activities; and Potential for colloid-facilitated transport for uranium and other metals.**

Response #90:

With the exception of porosity, EPA has removed the requirement to provide these properties for the CSM. EPA has determined that this information is not needed for development of the geochemical model. Most hydrologic properties needed for the geochemical model will be provided by the data collected during the wellfield pump test. However, site-specific measurements of aquifer porosity also are needed to assess reactive transport with the geochemical model. The Permit does not specify how porosity is to be determined, but common approaches include laboratory testing or geophysical logs. EPA has determined that colloid assessment is not required for the geochemical model, because the model simulates only dissolved fractions. In addition, NRC [NUREG-CR-6705](#) (Uranium Plume Attenuation Report) states that colloids are not an important transport mechanism for uranium. However, assessment of colloids may be required by the Director if necessary to accommodate and characterize areas of uncertainty as they relate to evaluating the potential for ISR contaminants to cross the aquifer exemption boundary as indicated by Part IV, Section A.4 of the Class III Area Permit.

**91. Powertech requested removal of the requirements found under Part IV, Section A.4 of the Class III Area Permit because they are not consistent with the NRC license. However, if the EPA does not satisfy this request, Powertech requests deletion of the text under Part IV, Section A.4 that requires the Permittee to certify that none of the activities listed under**

**Part IV, Section A.3 occurred that would trigger an update to the Conceptual Site Model, as required under Part IX, Section E.8.**

Response #91:

EPA did not make the requested changes to the Class III Area Permit. As explained in Responses #80 and #81 above, EPA's permit conditions must meet requirements under the Safe Drinking Water Act, which has a different purpose than UMTRCA, the statute under which the NRC issued its license. While the Class III Area Permit requirements may obligate Powertech to provide EPA more information than what is being required under the NRC license, they do not conflict with it. The information referenced by the commenter is being required because it is necessary in order to verify that no activities occurred during the reporting period that would trigger an update to the conceptual site model that supports the geochemical model.

**92. "Part IV, Section A 3. The Permittee shall update the CSM when any of the following occur." Powertech requests that EPA clarify what is meant by "the Director may require the Permittee to develop more than one CSM to accommodate and characterize the areas of uncertainty." Powertech understands the CSM represents data collection in advance of later geochemical modeling. However, in the above statement it appears that the CSM is some form of a modeling scenario.**

Response #92:

Part IV, Section A.4 requires the Permittee to update the CSM when certain situations occur. This includes when collecting data during wellfield development, the Permittee identifies data gaps or uncertainty concerning geology, hydrologic properties, geochemical characteristics, and/or geochemical processes that could affect mobility and transport of uranium and other metals. The need for more than one CSM may be required to accommodate and characterize the areas of uncertainty as they relate to evaluating the potential for ISR contaminants to cross the aquifer exemption boundary. For example, if a sensitive model parameter such as pE or alkalinity is not sufficiently well-characterized to constrain model results within the required 90-percent confidence interval, the Director may require the Permittee to collect additional data to reduce uncertainty in model predictions. Likewise, if model results during the calibration phase fail to match observed conditions and an acceptable match cannot be achieved by using the available information, the Director may require that other CSMs be evaluated that include other features such as localized clay layers, colloidal transport, or the effects of microbes. This approach will allow the geochemical model to simulate different scenarios around the uncertainty and indicate a potential range of outcomes.

**93. As requested in its Original EPA Letter Attachment A-3, Proposed Alternate Solution to Post- Restoration Groundwater Monitoring, a single model at the end of each major wellfield area (i.e., one geochemical model for the Dewey area and one geochemical model for the Burdock area) following completion of stability monitoring for each major wellfield area should be used. Requiring an iterative model that runs prior to completion**

**of stability goes well beyond the NRC license requirements and is potentially cost prohibitive.**

Response #93:

EPA has determined that because model calibration to transient geochemical conditions in the wellfield may not be feasible, the requirement to perform a transient calibration to wellfield conditions during the restoration phase and post-restoration stability monitoring phase has been removed from Part IV, Section B.5 of the Class III Area Permit. In place of the transient calibration, the Area Permit requires a steady-state calibration to background groundwater flow and geochemical conditions along a flowpath across the wellfield. Details concerning the calibration approach are presented in the revised Part IV, Section B.5. With the exception of Wellfields 6, 7, and 8, which are located upgradient from partially oxidized aquifer conditions, modeling may be initiated at the Permittee's discretion at the end of the post-restoration stability phase after all required data are collected. However, the Class III Area Permit retains the requirement to conduct modeling for each individual wellfield as a condition for Wellfield Closure. As discussed in Response #72 above, EPA has determined that having only one geochemical model in the Dewey area and one in the Burdock area does not provide sufficient certainty concerning the potential endangerment of USDWs.

As explained in Responses #80 and #81, UIC permits are not limited by NRC's requirements under UMTRCA. The UIC regulations require that when issuing permits, EPA ensures that USDWs are protected.

The UIC regulations do not provide for consideration of cost as a factor in determining permit conditions that are necessary to protect USDWs or to assure compliance with applicable requirements of the SDWA. However, EPA notes that although Powertech proposes to complete one model for the Dewey area and one for the Burdock area, each of these areas consists of 3 distinct aquifer layers (Upper Fall River, Upper Chilson, and Middle/Lower Chilson); therefore it would not be possible to have only one model per area and meet the conditions of the permit. As adequate confinement of these layers must be demonstrated as a condition to receive Authorization to Inject under Part II of the Class III Area Permit, the layers should be effectively hydraulically isolated from each other for the purposes of modeling. Therefore, at least 3 separate models will be needed for each major wellfield area to adequately represent flow and geochemical conditions within each layer. In addition, because the Chilson Sandstone downgradient from Burdock Wellfields 6, 7 and 8 has been partially oxidized by native groundwater, its capacity to immobilize uranium through reductive processes may be lessened. Therefore, geochemical modeling is required prior to receiving Authorization to Commence Injection at these wellfields, resulting in 3 additional individual wellfield models for a total of 9 models having different scales.

### **Aquifer Exemption**

#### **Clarifications**

**94. Some commenters submitted comments indicating some confusion about the aquifer exemption process. One commenter asked about the justification for this reclassification if**

**it involves groundwater contamination. Another commenter asked about whether there is a request for an exemption from treating the water.**

Response #94:

EPA clarified the purpose of the aquifer exemption (AE) by adding a statement in the background section to the final AE Record of Decision (ROD) that clarifies the purpose for the exemption is for the injection of lixiviant into of the uranium-bearing portions of the Inyan Kara Group for uranium recovery. The purpose of exempting the uranium-bearing portion of the Inyan Kara Group is to allow for the injection of lixiviant, a mixture of wellfield groundwater with carbon dioxide and oxygen.

When promulgating regulations for the UIC Program, EPA broadly defined the term “underground source of drinking water,” or “USDW.” See 49 Fed. Reg. 20137, 20141 (May 11, 1984). This was to effectuate Congress’s intent to protect current drinking water sources and *potential* drinking water sources from endangerment. However, recognizing that some aquifers that fall under the broad definition of an USDW would have value for purposes other than drinking water, EPA also included an aquifer exemption process to allow for injection into aquifers that would likely not be used for drinking water. That is the case with the uranium-bearing portions of the Inyan Kara aquifers in the Dewey-Burdock Project Area.

In the case of the Dewey-Burdock Project, the uranium-bearing portions of the Inyan Kara Group are USDWs as defined by 40 CFR § 144.3. For Class III wells, the UIC regulations do not allow movement of a contaminant into a USDW. See 40 CFR § 144.12(a) and (b). (For a more detailed discussion about the no-migration standard for Class III wells, see Response #84). Contaminant is broadly defined in the UIC regulations as “any physical, chemical, biological, or radiological [substance](#) or matter in water.” 40 CFR § 144.3. Therefore, in order to be able to inject into the USDW, permit applicants must seek approval for an AE by demonstrating the USDW meets the criteria for exemption under 40 CFR § 146.4. Such a demonstration would indicate that the aquifer does not have value as a source of drinking water. As EPA describes in the AE ROD, the Inyan Kara Group meets the criteria for an aquifer exemption because:

- It does not currently serve as a source of drinking water (40 CFR § 146.4(a)). This is based on a search for drinking water wells within 1.24 miles (2 km) of the project boundary and a determination that none of these wells draws water from the portion of the Inyan Kara Group to be exempted because the wells are either upgradient or cross-gradient relative to the direction of groundwater flow, hydrologically separated from the Inyan Kara Group, or were determined based on capture zone analyses to not draw from the aquifers.
- It cannot now and will not in the future serve as a source of drinking water because it contains minerals in a quantity and location that is expected to be commercially producible (40 CFR §146.4(b)(1)). This is based on geochemical and mineralogic information from approximately 5,932 drillhole logs, the presence of economically viable uranium roll-front deposits within the Inyan Kara Group, and an evaluation of the amenability of the mining zone to the proposed ISR mining method.

Once a USDW is exempted under the aquifer exemption process, it is no longer classified as a USDW; therefore, it is no longer subject to protection under the SDWA. Injection can occur into this portion of the aquifer, as it has been determined that it is not currently being used, and will not be used in the

future, as a drinking water source. The UIC regulations under the SDWA do not require restoration or treatment of this portion of the aquifer except to the extent it is necessary to prevent contamination of USDWs outside of the exempted area.

**95. Some commenters were concerned that the purpose of the aquifer exemption was to allow for injection of uranium waste products, radioactive waste, or toxic waste.**

Response #95:

The AE is being issued for the Inyan Kara Group in the mining area. EPA clarifies that there will be no injection of uranium waste products, radioactive waste, or toxic waste into the portion of the Inyan Kara Group where the mining will occur. Part VIII, Section H of the Class III Area Permit only allows injection of the following fluids into the Inyan Kara Group: ISR lixiviant consisting of wellfield groundwater with carbon dioxide and oxygen; permeate from reverse osmosis treatment of groundwater extracted from the post-ISR wellfields, clean makeup water, or groundwater recirculated within the wellfield; or a chemical reductant for purposes of aquifer remediation.

The aquifer exemption action is associated with the Class III Area Permit, and not with the Class V Area Permit, which does allow injection of treated uranium processing waste into the Minnelusa Formation. There is no aquifer exemption associated with the Class V permit.

**96. One commenter asserted that the applicant should be required to demonstrate that the aquifer can be restored before the aquifer exemption is approved.**

Response #96:

As explained above in Responses #16 and #53, the SDWA and the UIC regulations do not require that exempted aquifers be restored.

The portion of the Inyan Kara aquifer approved for exemption in this action does not have high value as a drinking water source, as it contains commercially producible amounts of uranium. Because of this, the aquifer contains elevated concentrations of total dissolved solids, sulfate, iron, manganese, gross alpha, radium-226 and occasionally uranium. As explained in the Record of Decision, this portion of the Inyan Kara meets the criteria for exemption under 40 CFR § 146.4. The AE regulation does not include a requirement to demonstrate that the aquifer exemption can be restored.

**97. Commenters expressed concern that approving the aquifer exemption would prevent further economic development downgradient of the exemption area.**

Response #97:

Approval of an AE for a portion of an aquifer should have no effect on the aquifer downgradient of the exemption area. EPA's permitting and AE actions ensure that contaminants from the allowed injection activity remain within the AE area within the approved injection zone. The AE Record of Decision Document includes a section entitled *Demonstration that the Injection Zone Fluids Will Remain within*

*the Exempted Portion* which includes a discussion of Class III Area Permit requirements that ensure the protection of USDWs downgradient from the ISR wellfields.

**98. Powertech requests clarifying the statement at the bottom of the page that “there is a hydraulic connection between the Fall River Formation and the Chilson Sandstone that would call into question the integrity of the Fuson Shale as an upper confining zone to the Chilson Sandstone”. Specifically, Powertech requests clarifying that this statement only applies to an isolated area. As currently written, the statement could be construed as indicating a general hydraulic connection across the permit area.**

Response #98:

The purpose of the sentence was to provide information about the hydraulic connection between the Chilson Sandstone and the overlying Fall River Formation identified by the water level response in the Fall River monitoring well during the Burdock Area pump test in the Chilson aquifer performed by Powertech and the Tennessee Valley Authority. EPA updated the aquifer exemption ROD to clarify that the Fuson Shale confining zone is continuous throughout the Project Area where the proposed ISR wellfields occur and the hydraulic communication is thought to be local to the pump test area.

**99. Powertech suggests replacing this figure 5 in the aquifer exemption Record of Decision or improving the image so that the well numbers are readable. Further, Powertech requests adding items not currently identified in the legend, including wells screened in the Inyan Kara and Unkpapa aquifers.**

Response #99:

EPA enlarged the map showing private well locations, now Figure 4, and added additional information to the map legend, including wells screened in the Inyan Kara and Unkpapa aquifers.

**100. Powertech requests adding “MCLs, or ACLs,” since these are alternate standards for groundwater restoration.**

Response #100:

EPA agrees with this comment that adding reference to MCLs or ACLs is a more accurate description of the NRC License requirement for groundwater restoration standards and made this change in the final ROD. This change was added to the final AE ROD.

**101. It appears that all of the information that was on pp. 22-25 of the first draft ROD has been inadvertently omitted from the second draft, including the last two paragraphs under Vertical Confinement and entire sections on Lateral Confinement, Monitoring Requirements, A perimeter monitoring well ring, Operational groundwater monitoring, Monitoring within the wellfield during groundwater restoration, A groundwater stability**

**monitoring period after restoration, Post-restoration groundwater monitoring, and Other Considerations. Powertech requests including this information in the final ROD based on what remains applicable.**

Response #101:

EPA has included these paragraphs in the Final AE ROD.

**102. The South Dakota Department of Environment and Natural Resources recommended the following clarifications in the aquifer exemption Record of Decision: Page 12, Flow Rates Used in the Capture Zone Equation - In the first paragraph of this section replace "South Dakota State Engineer's Office" with "South Dakota Department of Environment and Natural Resources"; Page 14, Flow Rates Used in the Capture Zone Equation - in the third paragraph on this page replace "State Engineer" with "South Dakota Department of Environment and Natural Resources"; Page 18 - 19, Demonstration that the Injection Zone Fluids Will Remain within the Exempted Portion - DENR recommends EPA include a bullet describing the Class III Area Permit mechanical integrity requirements as an additional factor supporting EPA's conclusion that adjacent USDWs will not be impacted.**

Response #102:

In the final aquifer exemption ROD document, EPA replaced "South Dakota State Engineer's Office" on page 12 under Flow Rates Used in the Capture Zone Equation and "State Engineer" on page 14 with "South Dakota Department of Environment and Natural Resources." EPA also added a bullet about Class III Area Permit mechanical integrity requirements to the section: Demonstration that the Injection Zone Fluids Will Remain within the Exempted Portion.

**103. A commenter expressed concern that the aquifer exemption boundary is not clear.**

Response #103:

EPA agrees that the draft AE boundary was confusing and unclear. The intent was to propose an aquifer exemption up to a maximum of a quarter mile away from the currently identified ore deposit boundaries, with the final AE boundary determination to occur after delineation drilling was completed. This was to give the public the opportunity to comment on an AE area up to a quarter mile away from the currently identified ore deposit boundary. To avoid confusion and provide clarity, EPA's final AE decision is to delineate a specific boundary at the time of permit issuance, based on the area that Powertech has demonstrated meets the criteria at 40 CFR § 146.4(b)(1). This area is within the maximum proposed area of ¼ mile away from the currently identified ore deposit boundary.

The Final AE ROD clarifies that EPA is approving the exemption of Inyan Kara aquifers 1,020 feet from the currently defined ore deposit boundaries for Burdock Wellfields 1 through 5, 9 and 10, as shown by the purple and green dashed lines in Figure E below. EPA is also approving the exemption of Inyan Kara aquifers 520 feet from the currently defined ore deposit boundaries for Burdock Wellfield 10 and Dewey Wellfields 1 through 4, as represented by the green dashed line in Figure E. The green dashed line is the

original AE boundary proposed by Powertech in the Class III Permit Application. The blue dashed line is the expanded AE area Powertech requested after the first draft Class III Area Permit was issued.

Powertech requested an expanded AE area to accommodate additional ore resources identified after the Class III Permit Application was submitted. EPA reviewed the Preliminary Economic Assessment reports developed by consultants documenting independent audits of mineral resource estimates at the Dewey-Burdock Project Site and determined that the commercially producible ore resource boundary had expanded in Burdock Wellfields 1 through 5, 9 and 10 since Powertech submitted the Class III Permit Application, justifying expanding the AE boundary for these wellfields. However, the commercially producible ore resource boundaries had not expanded for the other wellfields, so EPA did not expand the AE boundaries for these other wellfields. Because Powertech needs to do additional work to demonstrate that the potentiometric surfaces in Burdock Wellfields 6, 7 and 8 are able to sustain adequate monitoring of ISR operations in the overlying Upper Chilson aquifer, EPA is postponing approval the aquifer exemption in the area of Burdock Wellfields 6, 7 and 8 until Powertech performs further aquifer testing in that area.

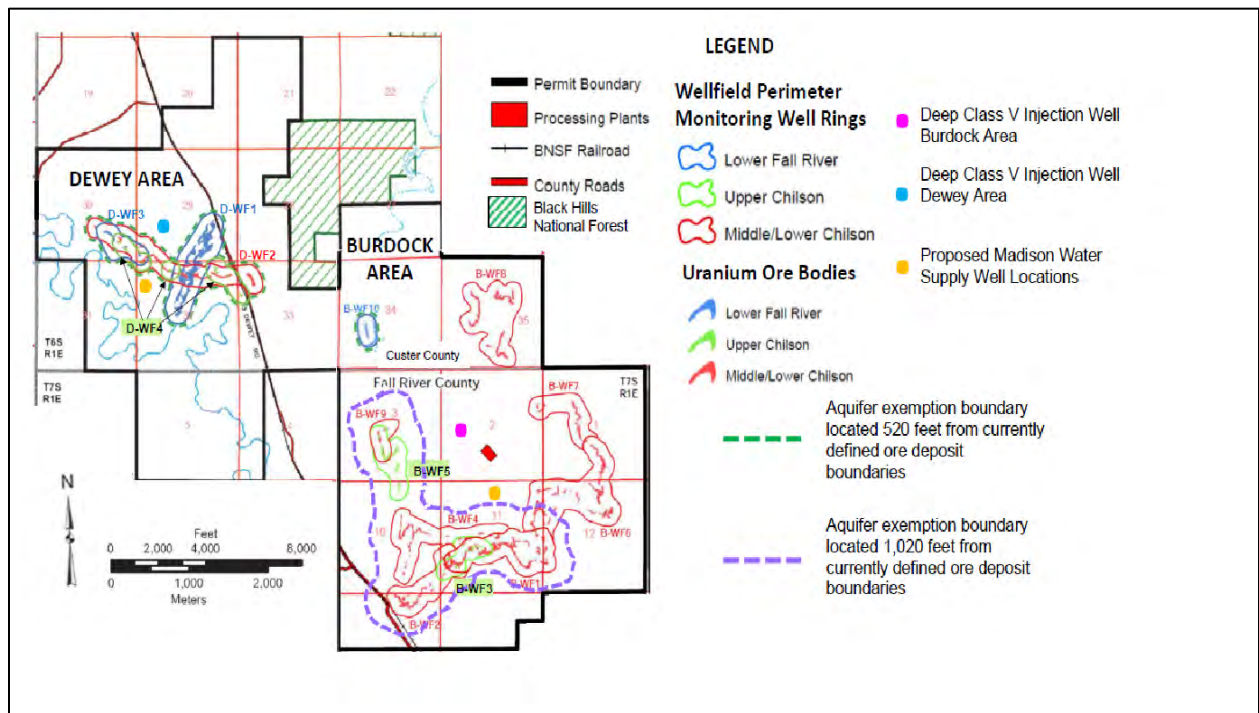

Figure E. Areas of the Inyan Kara Group aquifers approved by this Record of Decision.

104. When Powertech proposed the 120-foot offset distance at EPA’s request, it was unaware of the proposed permit conditions that would make this narrow buffer area operationally challenging. Accordingly, EPA should approve the ¼-mile buffer in the designation of the exempted aquifer if the proposed permit conditions are imposed, as described in Attachment A-10.



Response #104:

EPA does not agree that a quarter-mile buffer is appropriate because Powertech has not met the 40 CFR § 146.4 criteria for that entire area. As explained above in Response #103, EPA's final decision expands the AE boundary beyond the 120 feet originally proposed in the first draft permit to those areas where Powertech has demonstrated that there are commercially producible amounts of ore.

#### **Current/Future Source of Drinking Water**

- 105. One commenter raised the following concerns about the aquifer exemption criteria in 40 CFR § 146.4: Subsection (a), requiring current use of an aquifer is clearly inconsistent with Congress's intent that aquifers be protected if it is reasonable they could be used in the future. Subsection (b)(1) is similarly inconsistent with Congress's intent that water sources be protected, regardless of whether there are economically valuable minerals in the aquifer.**

Response #105:

This comment raises concerns about the aquifer exemption regulation, which is outside the scope of this AE determination. This commenter is raising a general concern that the AE criteria is inconsistent with Congress's intent under the Safe Drinking Water Act. The appropriate time to have raised concerns about the AE regulation was at the time that the regulation was proposed and open for public notice and comment.

- 106. Commenters asked the EPA to clarify how it determined that the exempted portion of the Inyan Kara Group is not currently used as a source of drinking water and would not be used in the future as a drinking water source. Commenters also asserted that the Inyan Kara Group is a current source of drinking water because it is being used by local residents via domestic and agriculture/livestock wells.**

Response #106:

The AE ROD explains EPA's evaluation of the AE criteria. As set forth in the ROD, Powertech submitted information based on the aquifer exemption criteria at 40 CFR § 146.4(a) (current use) and (b)(1) (future use). EPA's review found that the exempted portion of the Inyan Kara Group is not currently used as a source of drinking water. As explained in the document entitled "Enhancing Coordination and Communication with States on Review and Approval of Aquifer Exemption Requests Under SDWA," current source includes "water that is being withdrawn in the present moment as well as water that will be withdrawn in the future by wells that are currently in existence."

For current use, EPA searched for drinking water wells in the vicinity of the Dewey-Burdock Project boundary using historic well records, searches of state water well databases, and field investigations. This search identified 19 drinking water wells within 1.24 miles (2 km) of the project boundary. Except for well 16 located in NWSE Section 1, T7S R1E, all of these wells were evaluated and determined to be either upgradient or cross-gradient relative to the direction of groundwater flow, hydrologically

separated from the Inyan Kara Group aquifers, or not drawing water from the Inyan Kara Group based on capture zone analyses.

EPA also determined that there are no public water system wells, including municipal wells, utilizing the Inyan Kara Group downgradient of the Dewey-Burdock Project Area. As the AE ROD explains, reverse osmosis treatment of Inyan Kara groundwater is necessary to decrease the sulfate concentration below the secondary drinking water standards to make it palatable for human consumption. The City of Edgemont, the nearest municipal source, chose to drill an additional 2,400 feet to complete wells in the Madison Formation instead of using Inyan Kara groundwater for the public water supply. This provides further evidence that exempting a portion of the Inyan Kara Group does not negatively impact their current use as a drinking water supply.

EPA notes that the Inyan Kara Group aquifers are being used for drinking water and livestock watering outside of the aquifer exemption area. However, the Inyan Kara Group aquifers outside the AE area will not be adversely affected from the mining operation because the Permit does not allow contaminants to cross the AE boundary and adversely affect human health.

EPA determined that the future use criterion at 40 CFR § 146.4(b)(1) was also met. This criterion states that the aquifer cannot now and will not in the future serve as a source of drinking water because it is mineral, hydrocarbon or geothermal energy producing, or can be demonstrated by a permit applicant as part of a permit application for a Class II or III operation to contain minerals or hydrocarbons that considering their quantity and location are expected to be commercially producible. Additionally, as explained above, water from the exempted portion of the Inyan Kara group does not have high value as a drinking water source due to elevated levels of total dissolved solids, sulfate, iron, manganese, gross alpha, radium-226 and occasionally uranium.

- 107. Commenters expressed concern about EPA decision in the draft AE Record of Decision that well 16 is not a current source of drinking water. Commenters asserted that EPA and Powertech conspired to manipulate the current source status of well 16 because residents are still using the well. They pointed out that Powertech planned to disconnect the house from the well and provide the residents bottled water, but the well would still be used for livestock, and South Dakota law treats that the same as water provided for human consumption. Finally, they claimed that the EPA intended to eliminate the "or future source of drinking water" criterion by simply not considering future sources of drinking water with this aquifer exemption proposal.**

Response #107:

EPA did not approve exemption of the Inyan Kara aquifers in the area that includes well 16, so this comment is moot. See Change #23 under *Changes to the Class III Area Permit* and the Aquifer Exemption Record of Decision for additional explanation.

- 108. A commenter expressed concern that future private well users of the exempted portion of the aquifer may not be aware of the exemption.**

Response #108:

EPA has provided public notice of this aquifer exemption, consistent with the UIC regulations. Once approved, aquifer exemptions can be found on EPA's website through downloadable data and an interactive aquifer exemption map.

**109. A couple of commenters expressed concern about contamination of drinking water wells in the area. One commenter expressed that the State of South Dakota only began keeping records of wells in the recent past, so there are many undocumented domestic wells where people do not even know what aquifer their wells are in or how deep they are. The commenter stated that 22 domestic wells on the west side of Hot Springs were recently tested and all showed very low uranium levels and low to very treatable TDS, and all families but one were drinking the water, with only one using a softener and several just a sediment filter. Another commenter was concerned that there are people using the aquifer that may not want to identify themselves.**

Response #109:

Powertech performed a thorough search for wells completed in the Inyan Kara aquifers in and near the Dewey-Burdock Project site. Information from this well search is included in Appendices A and B of the Class III Permit Application. Powertech identified 19 domestic wells that are not used exclusively for stock water. Nine wells are located within the Project Boundary. Sixteen wells are still being used for drinking water. Table 8 of the Fact Sheet for the draft Class III Area Permit is a list of these wells. Figure 9 of the Fact Sheet for the draft Class III Area Permit shows the well locations.

Powertech also verified that there were no private wells completed in the Minnelusa injection zone inside the project boundary, as documented in Table C-1 of the Class V Permit Application. USGS Hydrologic Investigations Atlas, HA-745-C, Sheet 2 of 2, which shows the Minnelusa potentiometric surface around the southern Black Hills, shows water wells completed in the Minnelusa aquifer around Hot Springs, which is near the Minnelusa outcrop. (Strobel, M. L., et al., 2000, *Potentiometric Surface of the Minnelusa Aquifer in the Black Hills Area, South Dakota*, USGS Hydrologic Investigations Atlas HA-745-C, Sheet 2 of 2.) The map also shows Minnelusa water wells along the Cascade Anticline and one well on Dudley Anticline, where the Minnelusa aquifer occurs at a shallower depth along the axes of the anticlines. Figure G under Response #120 below shows the locations of some of these wells.

The 22 wells located on the west side of Hot Springs mentioned in the comment are completed in the Madison and Minnelusa aquifers. As commenters stated, the Minnelusa aquifer has good water quality in these areas because the mineral anhydrite that is prevalent in the Minnelusa Formation further downgradient has been dissolved out of the Minnelusa aquifer in and near the outcrop. Naus et al., 2001, discusses a dissolution front where the higher aquifer pressure of the underlying Madison aquifer is penetrating into the overlying Minnelusa Formation and dissolving anhydrite beds. North of the dissolution front, the anhydrite beds have been removed. The Minnelusa aquifer fluids are lower in sulfate and TDS because the anhydrite is no longer present. At the dissolution front, sulfate concentrations increase in the Minnelusa aquifer fluids because anhydrite is being actively dissolved by up-welling Madison aquifer fluids. South of the dissolution front, where anhydrite beds are still present

in the Minnelusa formation, the sulfate concentration is even higher because the aquifer fluids are in chemical equilibrium with the anhydrite in the aquifer formation.

Although USGS Hydrologic Investigations Atlas HA-745-C does not identify any water wells completed in the Minnelusa downgradient of the Dewey-Burdock Project Area, EPA specifically conducted an evaluation of water wells registered in the South Dakota Water Well Completion Report database to determine if any wells are located downgradient from the Dewey-Burdock site. EPA found that no water wells are completed in the Minnelusa Formation within about 18 miles in the downgradient direction from the site. (The downgradient groundwater flow direction in the Minnelusa aquifer from the Dewey-Burdock Site is discussed in Response #120 below.) Based on this evaluation, EPA has determined injection into the Minnelusa Formation at the Dewey Burdock site will not endanger the water wells located near Hot Springs where the Minnelusa groundwater quality is better because anhydrite has been dissolved away. In addition, EPA has determined that injectate from the Class V injection wells at the Dewey-Burdock site will not reach Cascade Springs or the wells near Hot Springs which are located further upgradient from Cascade Springs based on the discussion in the Response #120 below.

- 110. Powertech disagrees with the identification of Well 41 as a drinking water well (e.g., in Figure 3 and Table 3). As described in comment #60 in Table 1, Well 41 is a stock watering well at an uninhabitable residence that has not been inhabited for 30 years or more. Powertech requests removing this well from the capture zone analysis and Figure 3 in the draft Aquifer Exemption ROD.**

Response #110:

TVA records submitted as part of the Class III Permit Application indicated that well 41 was a domestic well at some time in the past, therefore EPA included this as a drinking water well for the purpose of conducting the capture zone analysis.

- 111. 13. Page 9, Option 2 - DENR recommends EPA select Option 2, plugging and abandonment of well 16. This is DENR's preferred option because it eliminates the possibility of well 16 being used as a drinking water well in the future.**

Response #111:

EPA did not approve exemption of the Inyan Kara aquifers in the area that includes well 16, so this comment is moot. See Change #23 under *Changes to the Class III Area Permit* and the Aquifer Exemption Record of Decision for additional explanation.

### **Commercial Producibility**

- 112. A number of commenters questioned the commercial producibility of the uranium ore at this site while others questioned Powertech's truthfulness about uranium deposit. One commenter asserted that "before the project goes any further, the company should be required to prove that there is the amount of ore present that it claims by providing**

**information under close supervision by a knowledgeable regulator selected by the EPA. As stated above, this should occur before any final permit is issued.” Other commenters claimed that previous mining operations, such as the TVA, found no further viable sources of uranium. Another commenter claimed that Powertech’s own Preliminary Economic Assessment related to this project notes uncertainty in whether the Dewey-Burdock Mine is even economically viable.**

Response #112:

EPA determined that Powertech met the AE future use criterion at 40 CFR § 146.4(b)(1) for the Inyan Kara aquifers in following areas: Burdock Wellfields 1, 2, 3, 4, 5, and 9, for a distance of 1,020 feet from the currently defined ore deposit, as shown by the blue line in Figure 2 in the AE ROD; and Burdock Wellfield 10 and Dewey Wellfields 1 through 4, 520 feet from the currently defined ore deposit boundaries, as represented by the green dashed line in Figure E of the AE ROD. The 40 CFR § 146.4(b)(1) criteria says that the portion of the aquifer to be exempted “cannot now and will not in the future serve as a source of drinking water because it is mineral, hydrocarbon or geothermal energy producing, or can be demonstrated by a permit applicant as part of a permit application for a Class II or III operation to contain minerals or hydrocarbons that considering their quantity and location are expected to be commercially producible.”

As explained in the AE ROD, to meet the “commercially producible” standard, the UIC regulations require an applicant to furnish the data necessary to demonstrate that the aquifer is expected to be mineral or hydrocarbon producing. “Information contained in the mining plan for the proposed project, such as a map and general description of the mining zone, general information on the mineralogy and geochemistry of the mining zone, analysis of the amenability of the mining zone to the proposed mining method, and a time-table of planned development of the mining zone shall be considered by the Director.” 40 CFR § 144.7(c)(1).

Powertech initially provided this information to EPA in its 2012 Preliminary Economic Assessment of the Dewey-Burdock Project Area (SRK, 2012). (SRK Consulting (U.S.), Inc., 2012, NI 43-101 Technical Report Preliminary Economic Assessment Dewey-Burdock Project) This document was published on SEDAR (System for Electronic Document Analysis and Retrieval) and was compliant with the National Instrument 43-101 Standards of Disclosure for Mineral Projects (NI 43-101) of the British Columbia Securities Commission. Powertech has released subsequent NI 43-101 reports to update the Dewey-Burdock uranium resource analysis, the most recent released in January 2020. (Graves and Cutler, 2019, NI 43-101 Technical Report Preliminary Economic Assessment Dewey-Burdock Uranium ISR Project South Dakota, USA, Effective date: December 3, 2019, Report Date: January 17, 2020) These documents are developed for Powertech by independent consultants for the purpose of auditing and confirming the resource calculations as well as the technical and economic viability of uranium recovery by ISR methods at the Dewey-Burdock Project.

EPA disagrees with the statement that the TVA determined there were no viable sources of producible uranium. The TVA conducted pump tests at the Dewey-Burdock site with the intention of developing underground uranium mines. The aquifer pumps tests were designed to determine the feasibility of dewatering the underground mine workings. TVA had plans to construct a uranium mill in the Burdock Area. This infrastructure is more expensive than the ISR process, but TVA’s analysis of drillhole data supported the expenditure at the time. It was the uranium price drop in the 1980s that caused the TVA

to abandon that mine development plan, not because the uranium ore deposits were not viable. (Bush, J., 2010, *NI 43-101 Updated Technical Report on the Dewey-Burdock Uranium Project Custer and Fall River Counties South Dakota*, at 12).

**113. The Bhattacharyya study (2017) indicates that there is far more organic uranium in roll front deposits, such as those at the Dewey Burdock site, than previously believed. This impacts both estimates of the amount of recoverable uranium at the site and the ability to restore the impacted aquifers post-mining. These factors need to be properly understood and evaluated for this site prior to permitting.**

Response #113:

EPA reviewed Bhattacharyya et al. (2017) but disagrees that Dewey-Burdock roll front ore deposits should be further evaluated prior to permit issuance to differentiate between non-crystalline uranium formed by biologically mediated reduction processes versus crystalline uranium mineralogy deposited through abiotic uranium reduction. EPA's interpretation of the information presented in the paper is that Bhattacharyya et al. (2017) suggested non-crystalline biogenically reduced uranium was a more labile form (has weaker chemical bonds) and is therefore potentially more economically extractable and more amenable to an environmentally benign mining process. Bhattacharyya et al. (2017) also suggested biogenically reduced uranium could lead to more effective post-mining restoration strategies. (Bhattacharyya, A., et al., 2017, *Biogenic non-crystalline U(IV) revealed as major component in uranium ore deposits*, *Nature Communication* 8:15538 DOI: 10.1038/ncomms15538.)

As discussed in Response #112 above, EPA determined that Powertech met the requirements in 40 CFR § 146.4(b)(1) and § 144.7(c)(1) for the demonstration that the uranium ore deposits are economically producible and amenable to the ISR process. In 2007, Powertech conducted a sequential leach "bottle roll" on core samples of the ore deposits in order to provide an indication of the mineralogical reaction rate with lixiviant and the percentage of potential uranium recovery. (Graves and Cutler, 2012 at 62). EPA determined that this was an adequate demonstration for the purposes of approving the aquifer exemption of uranium-bearing portions of the Inyan Kara aquifers.

**114. Powertech requests updating the reference on the commercial producibility of uranium to the most recent (2015) preliminary economic assessment for the Dewey-Burdock Project (Exhibit 026).**

Response #114:

Powertech provided this comment on the 2017 draft aquifer exemption Record of Decision. Since the 2015 preliminary economic assessment, Powertech has released a more recent report: Graves and Cutler, 2019, *NI 43-101 Technical Report Preliminary Economic Assessment Dewey-Burdock Uranium ISR Project South Dakota, USA*, Effective date: December 3, 2019, Report Date: January 17, 2020. EPA reviewed and considered this report in its decision.

**115. Commenters assert that, because there are likely organified forms of uranium created by bacteria, there is a low/limited amount of uranium that is recoverable using ISR.**

Response #115:

As stated in Responses #112 and #113 above, Powertech has demonstrated that there are economically producible ore deposits present within the requested aquifer exemption area at the Dewey-Burdock Project site and demonstrated that the uranium ore mineralogy is amenable to the ISR process.

### Class V Permit

#### Concern About Inaccurate Information

**116. The agency must also rely on its own work, not just the information provided by Powertech, for critical information such as the “maximum volume of liquid wastes injected into the deep injection wells during aquifer restoration” (Cumulative Effects, p. 76). This number is central to the discussion of the Class V wells and should be determined independently of the applicant. If this number is wrong, so are all the assumptions and mitigation measures offered in the draft permits and other project documents.**

Response #116:

EPA acknowledges the importance of accurate injection information. Under the Class V Permit, the Permittee is required to monitor and record injection pressure, tubing casing annulus pressure, injection rate, and cumulative volume of injected fluids. Self-monitoring and self-reporting are consistent with the SDWA and the UIC regulations. They are fundamental elements of the UIC permit program and other Federal regulatory programs. The UIC regulations (40 CFR § 144.51(k) and § 144.32) and the Permits have specific signatory requirements that certify that any reports submitted are complete, true, and accurate. The certification acknowledges that there are significant penalties for submitting false information.

EPA does not agree that injection volume is central to the discussion of the Class V wells in this case. Preliminary data indicate the Minnelusa injection zone is not a USDW, and EPA’s analysis indicates injectate will not flow to a USDW. Because an injection volume limit is only used to prevent migration of contaminants into a USDW, it is not necessary to have one if there is no potential for the injectate to migrate to a USDW. The Class V Area Permit requires the Permittee to demonstrate that the Minnelusa injection zone is not a USDW before EPA will issue Authorization to Commence Injection. If the Minnelusa injection zone is determined to be a USDW based on further testing, the Permittee must apply for a permit modification as described in Part IV, Section E in order to seek authorization to inject into the aquifer.

**117. The draft permit is not accurate on the depth of existing drilling on the site. According to the company’s Large Scale Mine permit application, drilling has been done on site down**

**to the Sundance aquifer. This means that information on the Minnelusa should already be available.**

Response #117:

As shown in Table 3 of the Fact Sheet for the draft Class V Area Permit, the base of the Sundance Formation is estimated to be about 695 feet above the top of the Minnelusa Formation at the Dewey-Burdock site. Therefore, wells drilled to the Sundance aquifer do not penetrate the Minnelusa, and information concerning the Minnelusa is not available for these wells.

### **Testing Before Permit Issuance**

**118. Several commenters asserted that water quality testing for the Minnelusa Formation (to determine whether it is a USDW) must be done prior to the issuance of a permit and under supervision of the EPA. They also assert that EPA should specify the locations for sampling. One commenter was concerned about EPA relying on data that will be obtained from drilling and testing the two proposed Madison water supply wells (which have not been approved by SD DENR) and drilling and testing the Class V wells, and on data on formations underlying the Minnelusa from well DW-1 if it is drilled to the base of the Deadwood Fm. as Powertech indicated in the Class V permit application (unclear if Powertech still plans to do this). This results in a difficult problem if Powertech cannot obtain any data hydrologic/ geologic on the Madison USDW or if data obtained indicate that the proposed injection zone does not meet the criteria specified in UIC regs.**

Response #118:

EPA generally requires testing for total dissolved solids (TDS), to determine whether an aquifer is a USDW, after permit issuance. There are several reasons for this. First, a UIC permit is the primary mechanism by which EPA can require an operator to perform actions. With no permit in place, there is no avenue for EPA oversight of any activities. Second, it is desirable to have well construction standards in place which the operator has to meet prior to drilling into the subsurface. These standards are set to prevent movement of fluid between formations. Finally, this testing process, which is commonly used in issuance of Class I, II, and III permits, allows EPA to have the above protections in place and still imposes requirements on the operator before any injection is authorized.

The Class V Area Permit has very specific injection zone sampling requirements the Permittee must follow at each deep well site to determine whether the TDS in the groundwater in the Minnelusa injection zone are 10,000mg/L or greater, and therefore not a USDW. As stated in Part II, Section D.1, Table 7 of the Class V Area Permit, prior to receiving authorization to inject, the Permittee must analyze fluid samples collected in the open wellbore from each of the individual aquifer intervals within the Minnelusa injection zone. This procedure allows Powertech to characterize the water quality from each injection zone aquifer interval prior to perforating the well casing. After well construction, the Class V Area Permit requires the Permittee to collect cased-hole swab samples from each perforated interval in the Minnelusa to verify previously measured TDS is 10,000 mg/L or greater, thus confirming that each injection interval is not an USDW.



Part II of the Class V Area Permit still contains requirements for hydrogeological data collection during the drilling of Madison water supply wells, if they are drilled. These requirements serve the purpose of further verifying the adequacy of the lower Minnelusa confining zone that separates the Minnelusa injection zone from the underlying Madison USDW. EPA determined that Powertech demonstrated the presence of adequate confining zones in the Class V Permit Application. In addition, EPA analyzed the lower Minnelusa confining zone in a number of oil and gas test well logs as discussed in the following response. However, if site-specific information required by the Class V Area Permit should show that the Minnelusa injection zone and confining zones do not meet the criteria in UIC regulations, EPA will not authorize injection into the Class V wells.

If the sample is under 10,000 mg/L TDS, and therefore a USDW, injection cannot be authorized under the Class V Area Permit. In order to inject under that scenario, the Permittee would need to request an aquifer exemption and seek modification of the Class V permit. These actions would be subject to public notice and comment. There is no plan to drill into the Deadwood Formation.

**119. One commenter asserted that lack of hydrologic data for the Minnelusa Formation injection zone and the Madison Formation results in uncertainty that is too great and does not support a decision that there is an adequate lower confining zone. It may also mean that more than 4 injection wells will be required to limit injection rates and pressures.**

Response #119:

The information reviewed by EPA provided an adequate demonstration of confinement for purposes of permit issuance and will be verified through the Class V Permit's logging and testing requirements prior to issuance of an authorization to inject. EPA has reviewed logs for the oil and gas test wells located within the Class V permit Area of Review. Although only one well was drilled completely through the Minnelusa Formation into the Madison Formation, eight other oil and gas test wells near the Dewey-Burdock Project Site do penetrate some distance into the Lower Minnelusa Formation and provide evidence of the presence and thickness of the Lower Minnelusa confining zone at the Dewey-Burdock Project Site. The locations of the oil and gas test wells are shown in Class III Permit Application Plate 3.1. Information on the depth each well was drilled and how far into the Minnelusa Formation each well extends is included in Table 10 of the Fact Sheet for the draft Class III Area Permit. In addition, the Class V Area Permit contains logging and testing requirements to verify the presence and thickness of the upper and lower confining zones for the Minnelusa injection zone at the Dewey-Burdock site. If the well logging information provided to EPA does not confirm the existence of confining zones for the Minnelusa injection interval at the location of each injection well, EPA will not issue the Authorization to Commence Injection for that well. The commenter does not express why this process is not adequate to protect USDWs.

Naus et al., 2001, also provides information about the differences in chemistry of groundwater quality between the Madison and Minnelusa aquifer that demonstrate adequate confinement between the two aquifers in areas downgradient from the dissolution zone shown in Naus et al., 2001 Figure 11. This information is discussed in Section 3.3.3 of the Fact Sheet for the draft Class V Area Permit.

Finally, the commenter does not explain why he believes more than 4 injection wells would be required to limit injection rates and pressures, and EPA does not agree with this assertion. Any uncertainties

about hydrologic data will be verified through well logging and testing prior to authorization to inject. Section 4.4.2.2 of the Fact Sheet for the draft Class V Area Permit discusses EPA calculations of injection rates using Minnelusa aquifer data available from Class V Permit Application.

### **Concerns About Geology and Confinement**

**120. Some commenters raised concerns about the Madison aquifer, stating that the Madison aquifer is a source for artesian springs in the area, citing to the following report: Naus et al, Geochemistry of the Madison and Minnelusa Aquifers in the Black Hills Area, South Dakota, Water Resources Investigations Report 01-4129, 2001, p. 2. They assert that the EPA discounts the potential for migration upward from the Minnelusa into the Madison Formation. They expressed concern that contamination of the Madison formation potentially impacts surface water through artesian springs.**

Response #120:

There is no potential for migration of fluid upward from the Minnelusa Formation into the Madison because the Minnelusa Formation is above the Madison Formation.

If instead the commenters are concerned about the confinement between the Minnelusa and Madison, EPA provides this response to inform the commenters about the review of information regarding confinement at the Dewey-Burdock site, which includes the Naus et al. report that commenters refer to. The information below summarizes EPA's review and concludes that there is no communication between the Minnelusa and Madison Formations at or downgradient from the Dewey-Burdock site

The Minnelusa Formation aquifer is the injection zone for the Class V deep injection wells. The Minnelusa Formation overlies the Madison Formation, which is also an aquifer. The Lower Minnelusa is comprised of low permeability strata which form the lower confining zone separating the Minnelusa injection zone and the underlying Madison aquifer. As stated in Response #119 above, EPA has confirmed the thickness and horizontal continuity of the Lower Minnelusa confining zone through observations of oil and gas test well logs in and around the Dewey-Burdock Project Site.

Naus et al., 2001, states "Low-permeability layers in the lower part of the Minnelusa Formation generally act as an upper confining zone to the Madison aquifer. However, karst features in the top of the Madison Limestone may contribute to reduced competency of the overlying confining zone in some locations." These locations occur north of the Dewey-Burdock Project Site, but not within the Project Site. Figure 11 in Naus et al., 2001, shows the location of a dissolution front, also mentioned in Class III Permit Application Appendix E, which discusses the location of breccia pipes occurring in the Minnelusa and overlying stratigraphic units 8 to 25 miles north and east of the Dewey-Burdock project boundary. At this dissolution front, the higher elevation potentiometric surface of the Madison aquifer is penetrating into the Minnelusa Formation and dissolving anhydrite (calcium sulfate) beds. North of the dissolution front, the anhydrite beds have been dissolved away. As a result, Minnelusa aquifer groundwater is lower in sulfate because the anhydrite is no longer present. At the dissolution front, sulfate concentrations increase in the Minnelusa aquifer because anhydrite is being actively dissolved by up-welling Madison aquifer fluids. South of the dissolution front, where anhydrite beds are still present

in the Minnelusa formation, the sulfate concentration is even higher because the aquifer fluids are in chemical equilibrium with the anhydrite in the aquifer formation.

Section 3.3.3 of the Fact Sheet for the draft Class V Area Permit summarizes information presented in Naus et al., 2001, confirming hydraulic separation of the Minnelusa and Madison aquifer downgradient of the dissolution front, including marked differences in major anion and cation chemistry between the two aquifers and difference in aquifer potentiometric surfaces. Naus et al. documents these characteristics at what is called “paired wells” which are wells located near each other, with one well completed in the Minnelusa aquifer and the second completed in the Madison aquifer. Paired wells in locations where there is little to no hydraulic separation between the two aquifers show similar groundwater chemistry and potentiometric surface elevations. Paired wells in locations where there is hydraulic separation between the two aquifers show very different groundwater chemistry and potentiometric surface elevations as demonstrated in Figures 6 and 7 of the Fact Sheet for the draft Class V Area Permit showing information from the paired wells nearest the Dewey-Burdock Project Area.

EPA investigated groundwater flow directions in the Minnelusa aquifer at the Dewey-Burdock Project Site and at the springs, such as Cascade Springs, south of the Black Hills. Figure F is a groundwater flow direction map from Figure 17 in Driscoll et al., 2002. This map shows the direction of groundwater flow in the Minnelusa aquifer from its recharge area in the Black Hills to a discharge area located at the eastern edge of the Cheyenne River Reservation. As shown in the map in Figure F, the authors hypothesize that the Minnelusa aquifer groundwater flows from the Dewey-Burdock site and flows around the southern end of the Black Hills toward the Williston Basin. (Driscoll, D.G., et al., 2002, *Hydrology of the Black Hills Area, South Dakota*, USGS Water-Resources Investigations Report 02-4094 at 22)

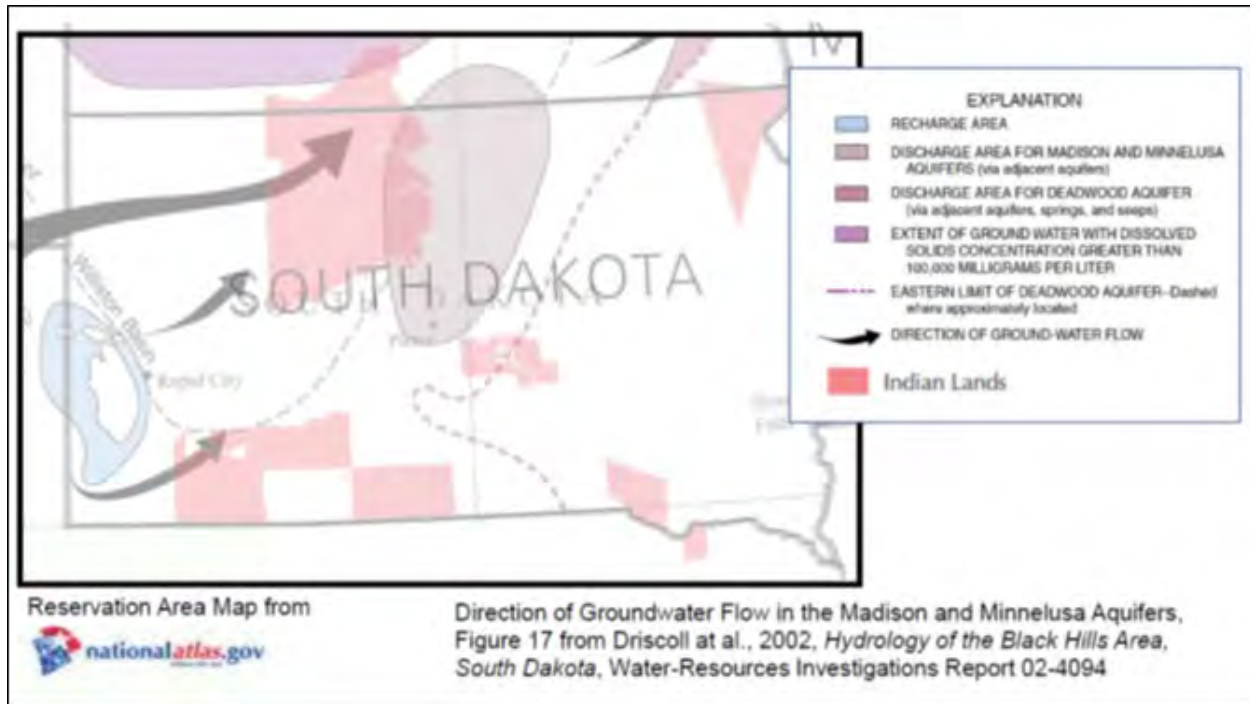
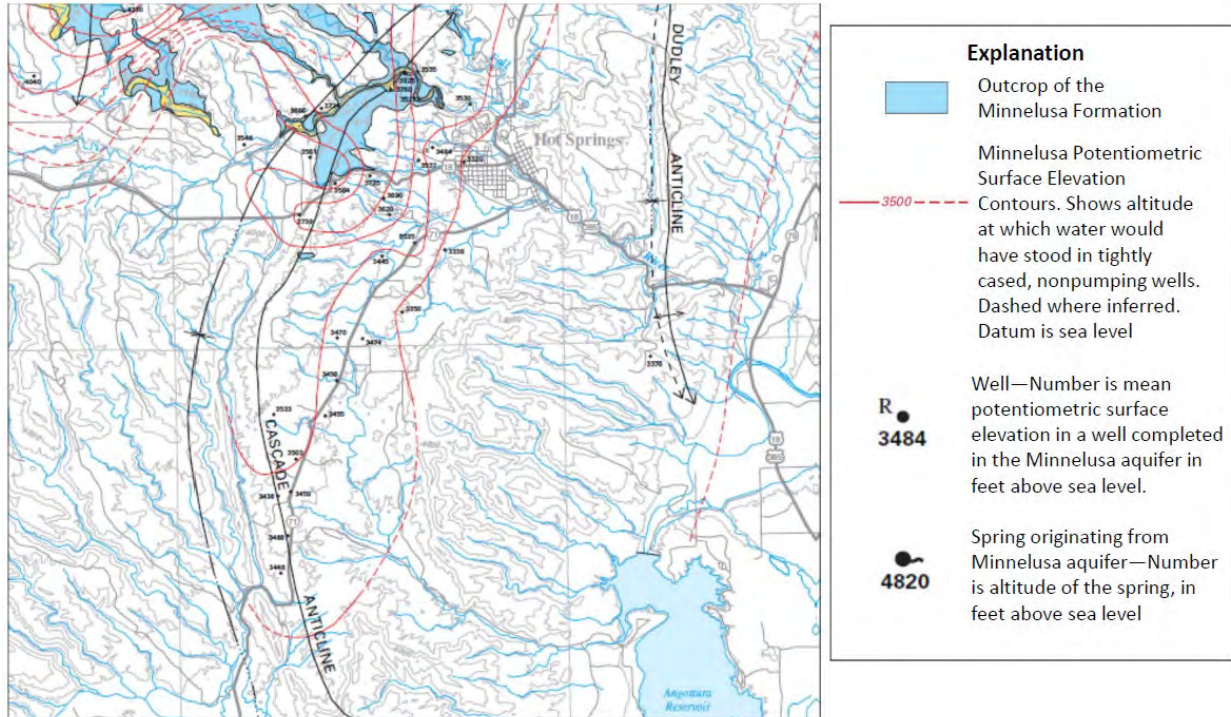

Figure F. Minnelusa aquifer groundwater flow direction map from Figure 17, Driscoll et al., 2002.

Figure G is the area where springs, including Cascade Springs, are located south of the Black Hills, excerpted from Sheet 2 of Strobel et al., 2000. The red lines show the potentiometric surface elevations based on wells completed in the Minnelusa and springs flowing from the Minnelusa. The potentiometric surface contours are deflected southward along the Cascade anticline where the Minnelusa and other geologic strata are raised in elevation. (Strobel et al., 2000)



**Figure G. Minnelusa aquifer potentiometric surface elevation contours in the area where springs occur south of the Black Hills (from Sheet 2, Strobel et al., 2000)**

Figure H shows the area south of the Black Hills, excerpted from Sheet 2 of Carter and Redden, 1999. (Carter, J.M. and Redden, J.A., 1999, *Altitude of the Top of the Minnelusa Formation in the Black Hills Area, South Dakota*, USGS Hydrologic Investigations Atlas HA-744-C, Sheet 2) In this figure the red lines are elevation contours along the top of the Minnelusa Formation. The springs shown in Figure G are located inside the green oval. Based on the elevation of the top of the Minnelusa Formation shown in the area where springs occur south of the Black Hills, the top of the Minnelusa Formation is at a higher elevation at this location than at the Dewey-Burdock Project Site. Figure H shows how the Cottonwood, Chilson and Cascade anticlines affect the Minnelusa Formation elevation. The Class V injectate from the Dewey-Burdock site would have to flow uphill to reach the location of these springs. Based on the potentiometric surface contours in Figure G, the flow path of Class V injectate would be deflected to the south by the Chilson and Cascade anticlines and would have to flow uphill to reach these springs where Minnelusa and Madison groundwater flows to the surface.



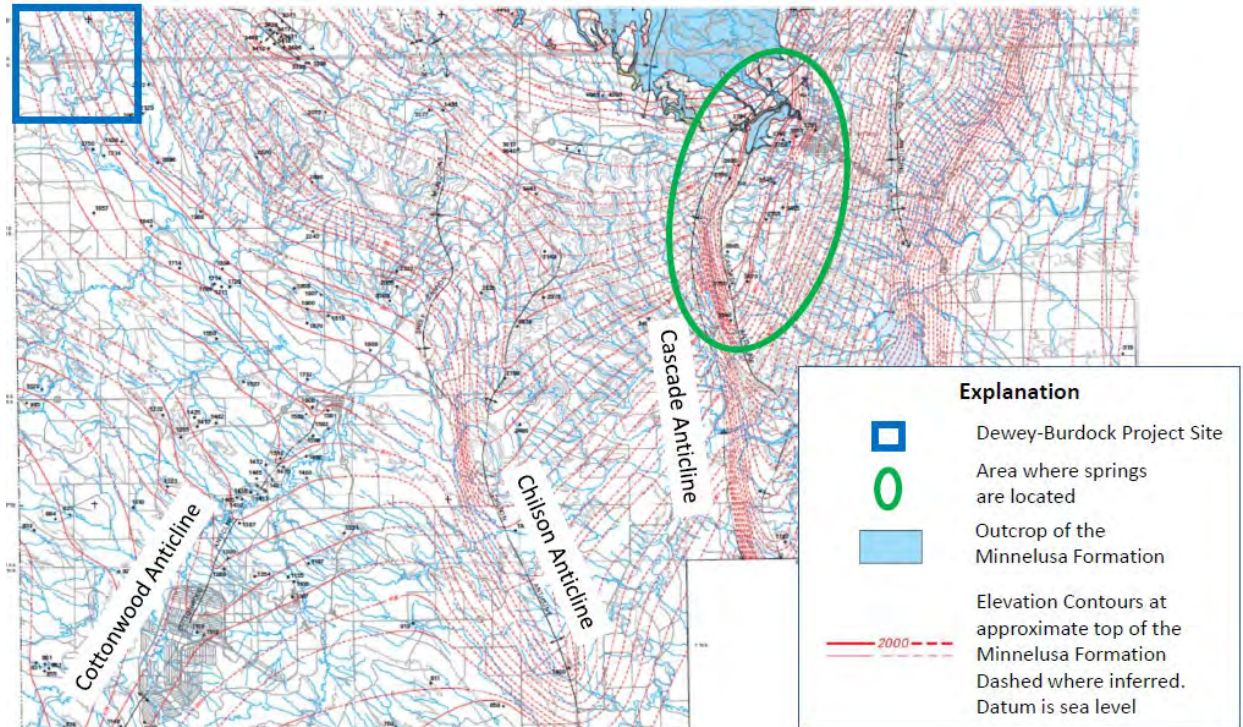

Figure H. Elevation of the Minnelusa Formation top surface (Source: Sheet 2 of Carter and Redden, 1999)

EPA reviewed water well logs in the area near the springs flowing from the Minnelusa and Madison aquifers. Figure I shows locations of Minnelusa (green) and Madison (red) wells and springs. The blue table in Figure I shows the depth to the top of the Minnelusa Formation in the logs for wells shown in Figure H. The springs occur where the top of the Minnelusa aquifer occurs closer to the ground surface. For example, at the location of the springs shown in Figure H the top of the Minnelusa is approximately 200 feet or less below ground surface, based on nearby private well logs.

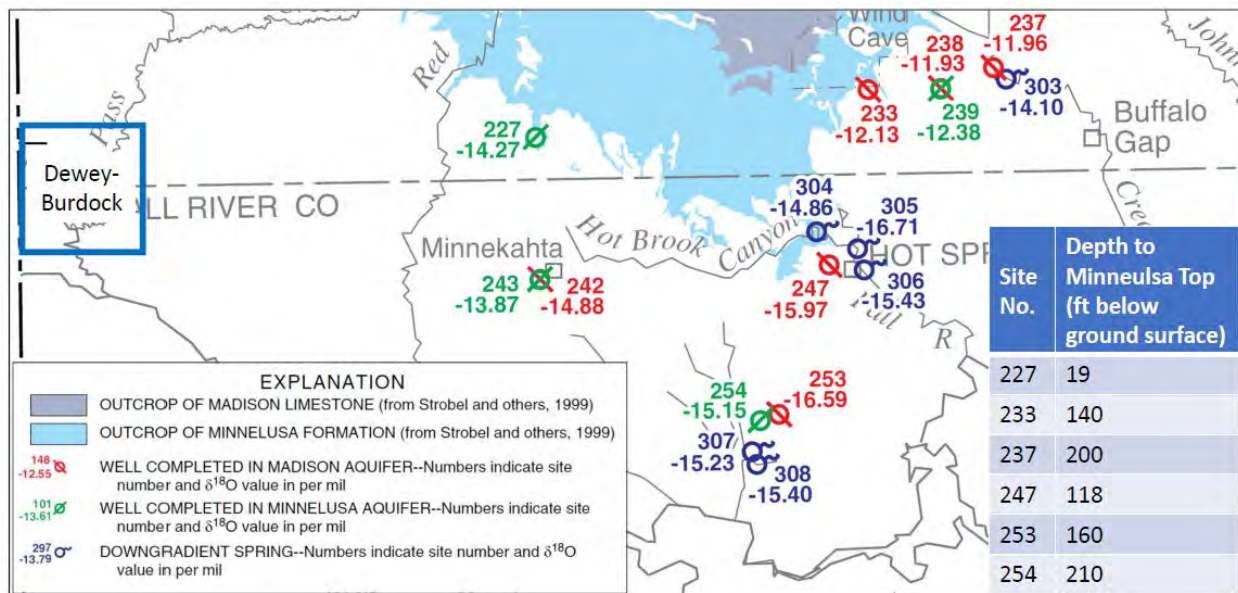

Figure I. Locations of springs emanating from or passing through the Minnelusa aquifer, from Figure 29 of Naus et al., 2001.

Based on this analysis, EPA concludes that the Class V injectate will not contaminate the Madison aquifer and will not reach the area where the artesian springs are located.

**121. The EPA received comments about the critical pressure calculations around movement of fluid between the Minnelusa Formation and the Madison Formation. Some commenters were concerned about protecting the Madison Formation. “EPA calculations indicate that ‘the pressure within the Minnelusa injection zone resulting from injection activity is not below the critical pressure needed to move fluids out of the Minnelusa injection zone into the Madison Formation. The EPA correctly requires the company to recalculate in light of this fact, but must also hold firm if the resulting injection rates are even near the critical pressure, with the potential result that the permit would not be granted. Again, it is critical to protect the Madison aquifer, and the nature of the upper portion of that aquifer is particularly concerning due to the presence of rapid water movement.”**

**Commenters were also concerned assumptions can vary the critical pressure rise results widely. They suggested more oversight by EPA is needed rather than simply letting Powertech "recalculate the critical pressure rises for each injection zone based on the site-specific information collected during the construction of each well." Finally, one commenter expressed concern about migration downward. They asserted that “calculations performed by EPA staff indicate that the injection induced pressure within the injection zone will exceed the critical pressure needed to move waste fluids into the underlying Madison USDW for a distance of 3.5 miles from DW1 and 2.5 miles from DW-3. This means that there is a significant potential for waste fluid injectate to migrate downward through natural geologic pathways (faults, fractures, high permeability zones) or anthropogenic features (abandoned oil/gas wells). There is significant disagreement on this between EPA and Powertech based on very different calculations of the critical pressure.”**

Response #121:

EPA agrees that it is important to protect the Madison aquifer as well as other USDWs. The Class V Area Permit includes provisions addressing the commenters' concerns. For example, the Class V Area Permit requires the Permittee to calculate the critical pressure rise needed to move injection-zone fluids into the Unkpapa/Sundance and Madison USDWs based on site-specific data and to calculate the induced injection-zone formation pressures resulting from injection activity, including the cumulative effects of injection from multiple wells as applicable. The Class V Area Permit also requires the Permittee to calculate maximum injection rates for each well that will not result in a critical pressure exceedance within 1,000 feet of the nearest pathway through the confining zones. EPA will review these maximum injection rates and set an injection rate permit limit low enough to maintain the injection zone fluid pressure to below the critical pressure at the required distance. Critical pressure rise and injection zone pressure calculations considered together with the maximum injection rate limit, must be submitted to EPA Director for approval prior to obtaining Limited Authorization to Inject. For authorization to be granted, calculations must demonstrate that the injection well is located a sufficient distance from any

feature that has the potential to serve as a pathway for fluid migration out of the injection zone into a USDW.

- 122. Commenters raised concerns about uncertainty of data affecting calculations: porosity of the injection zone, the elevation of the potentiometric surface of the Madison Formation and the effect of pumping by two proposed Madison water supply wells. Commenters claimed the data are necessary for calculating the distance over which the injection-induced pressure exceeds the critical pressure needed to move waste fluids downward to the Madison. To be conservative the Area of Review should extend at least 3.5 miles from each proposed class V well.**

Response #122:

EPA agrees that the Area of Review (defined at 40 CFR § 146.6) should be calculated based on adequate site-specific data. As Section 4.4.1 of the Fact Sheet for the draft Class V Area Permit describes, Part II, Section F.1 of the Class V Area Permit requires the Permittee to recalculate the critical pressure increases for each injection zone based on the site-specific information that will be collected during the construction of each well. This includes the thickness of the Minnelusa Formation injection zone based on well logging, and porosity values that are based on laboratory testing of core samples and porosity logs. If the Madison water supply wells are drilled, the Class V Area Permit requires the Permittee to run tests and logs on these wells. After testing of the Madison aquifer has provided information on the potentiometric surface and other required parameters, Part II, Section E.3.b of the Final Class V Area Permit requires the Permittee to generate a drawdown model of the change in the potentiometric surface of the Madison aquifer that can be expected to result from 10 years of pumping at each of the Madison water supply wells and to use this information in the calculations required under Part II, Section F.1.

Although EPA diffusivity calculations based on preliminary data indicate the distance from DW No. 1 in the Burdock Area where the injection zone pressure would be above the critical pressure is about 3.5 miles, the Class V Area Permit requires the Permittee to determine the maximum injection rate such that the critical pressure in the injection zone is not exceeded within 1,000 feet of the nearest potential breach in confining zones, as discussed in Sections 4.4.2, 5.4.3 and 7.7.2 of the Fact Sheet for the draft Class V Area Permit. EPA will review these maximum injection rates and set an injection rate permit limit low enough to maintain the injection zone fluid pressure to below the critical pressure at the required distance. EPA's Authorization to Inject will include the maximum injection pressure and rate permit limits that will be based on site-specific information, as described in Part II, Section J and Part II, Section F.3 of the Class V Area Permit.

- 123. Commenters expressed concern that the fluid injected into the Class V wells will not be adequately confined in the Minnelusa Formation and may contaminate drinking water in other aquifers. They cite to a USGS report stating that “[f]racturing from folding and brecciation near the outcrop may have increased the permeability of the lower part of the Minnelusa a considerable, but unknown, amount” (Kyllonen, D. P., & Peter, K. D., 1987).**

Response #123:

While EPA acknowledges that fracturing from folding and brecciation near the outcrop may have increased the permeability of the lower part of the Minnelusa in these areas, EPA's review of this issue, including review of the USGS report cited by commenters, indicates adequate confinement in the project area.

As noted additionally by Kyllonen and Peter (1987), brecciation near Minnelusa outcrop areas is the result of dissolution and transport of anhydrite and gypsum in the formation. The approximate location of the Minnelusa anhydrite dissolution front is presented in Figure 11 of Naus et al. (2001) and is mentioned in the Class III Permit Application Appendix E, which discusses the location of breccia pipes occurring in the Minnelusa and overlying stratigraphic units 8 to 25 miles north and east of the Dewey-Burdock project boundary. EPA specifically evaluated the potential for the presence of breccia pipes in the project area. Based on this evaluation, EPA has determined they do not exist in the project area. In addition, EPA has extensively evaluated information about regional and local geology of the area where the Dewey-Burdock Project site is located and determined there is evidence that adequate confining zones are present to protect USDWs by vertically isolating the Class V Minnelusa injection zone to prevent vertical fluid movement out of the approved injection intervals or zone. This must be confirmed by logging and testing before EPA authorizes any injection. Section 3.3 of the Fact Sheet for the draft Class V Area Permit discusses EPA's evaluation of the confining zones.

- 124. Some commenters cited specific concerns regarding drinking water from wells into the Minnelusa. These commenters get water from other parts of the Minnelusa aquifer.**
- **(see attached well log data from Ferguson well adjacent to Belitz 320 ft well. Belitz well log is missing) (note flowing cave in Ferguson well). These proposed mining activities pose a risk to my Inyan Kara water by undetected or late detected excursions as I am down gradient from the mining activity.**
  - **Our property, located at 2244 Minnekahta Ave, has a well in the Minnelusa Aquifer. The water is great and we currently use it extensively to grow organic vegetables, feed our animals as well as many other uses as needed outdoors. Since our property is 2 acres, it is large enough to sub-divide in the future if we so choose. Any additional structure we may build on our property could be tap into our well for potential household use. That is of course unless you approve this permit.**

Response #124:

EPA acknowledges that wells completed in parts of the Minnelusa aquifer are used to supply drinking water. However, injection into the Minnelusa Formation at the Dewey Burdock site will not endanger existing water wells.

Minnelusa groundwater travels along different paths. As shown in Figure F under Response #120 above, regional groundwater flow paths in the Minnelusa Formation generally appear to trend southeast away from the Dewey Burdock site (Driscoll et al., 2002, Fig. 17). Although records on file with the South Dakota Department of Environment and Natural Resources indicate some water wells are completed into the Minnelusa Formation east and southeast of the site, most of these wells are located upgradient or along a structurally high area near the Cascade Anticline (Dewey Burdock Class V Permit Application,



Fig. D-8; Carter and Redden, 1999) where the Minnelusa crops out or occurs at shallow depths approximately 20 miles east of the site (Dewey Burdock Class V Permit Application, Fig. D-1; Driscoll et al., 2002, Fig. 14). Potentiometric contours for the Minnelusa aquifer (Driscoll et al., 2002, Fig. 70) indicate water wells in the structurally high area are not in the flow path of Minnelusa groundwater from the Dewey-Burdock site. The difference in flow paths is further supported by the difference in Minnelusa water quality between the two locations. Whereas the total-dissolved-solids concentration of deep Minnelusa groundwater at the Dewey-Burdock site is expected to exceed 10,000 mg/L, the shallow Minnelusa Formation along the anticline supplies fresh groundwater to wells in this area.

Two of the wells specifically referenced in the comments (Ferguson and 2244 Minnekahta Lane) are located along this anticline and are not in the Minnelusa flow path from the Dewey-Burdock site. Based on a review of lithologic logs for the Belitz well and other nearby wells, it does not appear that the Belitz well penetrates to the Minnelusa Formation. EPA specifically conducted an evaluation of water wells potentially downgradient from the Dewey-Burdock site and found that no water wells were completed in the Minnelusa Formation within about 18 miles downgradient from the site. Based on this evaluation, EPA has determined injection into the Minnelusa Formation at the Dewey Burdock site will not endanger existing water wells.

**125. Other commenters claim there are hundreds to thousands of domestic wells using water from the Minnelusa Aquifer, although the exact number of wells is unknown at this time. They said it is known that there are 196 appropriated water rights permits in the Minnelusa, which include municipal, commercial, industrial, and housing use.**

Response #125:

EPA specifically conducted an evaluation of water wells potentially downgradient from the Dewey-Burdock site and found that no water wells were completed in the Minnelusa Formation within about 18 miles downgradient from the site. Based on this evaluation, EPA has determined injection into the Minnelusa Formation at the Dewey Burdock site will not endanger existing water wells.

As expressed in Response #124 above, EPA acknowledges that many wells use water from parts of the Minnelusa aquifer. The Minnelusa Formation has a large regional extent and is exposed in outcrop surrounding the Black Hills uplift but dips downward into the subsurface away from the Black Hills (Driscoll et al., 2002). Regional groundwater flow paths in the Minnelusa generally are outward from the Black Hills with flow on the west side wrapping to the north and south around the uplifted area and then heading eastward and northeastward (Driscoll et al., 2002, Figs. 17 and 70). Regional groundwater flow paths in the Minnelusa Formation generally appear to trend southeast away from the Dewey Burdock site. Although many water wells are known to be completed in the Minnelusa aquifer, most of these wells are upgradient or not in the flow path of groundwater from the Dewey-Burdock site. Furthermore, the total-dissolved-solids concentration of Minnelusa groundwater at the Dewey-Burdock site is expected to be greater than 10,000 mg/L, which makes it unlikely that Minnelusa groundwater would be used to supply drinking water in this area.

**126. Commenters claimed that the Minnelusa Aquifer meets the criteria for an underground source of drinking water, and therefore, injection should not be allowed.**

**They cited to water testing of the Minnelusa at a different site, indicating total dissolved solids (TDS) values below 10,000mg/l. Further, commenters asserted that because there are not barriers to water flow in the Minnelusa, it is not eligible for an aquifer exemption.**

Response #126:

Aquifers can have different total dissolved solids (TDS) values in different areas of the aquifer. Therefore, while it may be an underground source of drinking water (USDW) at a different site, data reviewed by EPA indicates that it is unlikely for the TDS to be below 10,000 mg/L at this site and would be a non-USDW. The Class V Permit requires water sampling of the Minnelusa after well construction. The Permit only allows injection if the sample is over 10,000mg/L TDS and the Minnelusa is a non-USDW at the well site.

There is currently no aquifer exemption request before EPA for the Minnelusa aquifer. If one is requested in the future, the aquifer exemption process includes an opportunity for public notice and comment.

**127. There seems to be a lot of emphasis on 'down-gradient' numbers however it is not reasonable to assume the large quantity of water pumped back into the Minnelusa under pressure would resemble the natural percolation of water rather it would make traditional directional flow null and void. Though they keep referring to intervals of the Minnelusa it is irresponsible not to treat the aquifer as one entity due to the aforementioned gaps in knowledge of hydrology and geology.**

Response #127:

Although injection into the Minnelusa through each Class V well will change local hydraulic gradients, measurable changes would occur only over a limited distance, and regional flow in the Minnelusa aquifer would not be substantially affected. Additionally, local pressure effects of injection will dissipate over time once injection ceases, allowing hydraulic gradients to return to conditions representative of groundwater flow prior to injection. Part II, Section F.2 of the Class V Area Permit requires the Permittee to calculate injection-induced formation pressures as a function of distance away from each Class V disposal well based on the site-specific information collected during well construction. Cumulative pressure effects of injection from multiple wells must be considered in the calculations as applicable.

With respect to the commenter's concern that the Minnelusa Formation should be treated as one entity, EPA has extensively evaluated information about the regional and local geology of the area where the Dewey-Burdock Project site is located. As discussed in Section 3.0 and shown in Appendix A of the Fact Sheet for the draft Class V Area Permit, lithology of the Minnelusa Formation varies with depth. The upper part of the Minnelusa, which represents the injection zone, consists primarily of porous sandstones with interbedded shale and anhydrite. Sandstones in this part of the formation are more permeable due to a lack of mineral precipitation between the sand grains. The lower part of the Minnelusa is composed primarily of Interbedded cemented sandstones with dolomite, shale and anhydrite. Sandstones in the lower part of the Minnelusa are less permeable due to greater prevalence of cement filling the pore spaces between sand grains. The lower Minnelusa also contains more dolomite and shale beds. Based on analysis of logs from the oil and gas test wells in the Dewey-Burdock

area, EPA has determined there is evidence that the confining layers that separate the Minnelusa injection zone from other parts of the Minnelusa Formation are laterally extensive in the area of the Dewey-Burdock site and are sufficient to vertically isolate the Class V Minnelusa injection zone to prevent vertical fluid movement out of the approved injection zone into USDWs. To verify that injection will not occur into a USDW, the Class V Area Permit requires that each individual sandstone in the Minnelusa injection zone be sample for total dissolved solids (TDS). If any of the samples indicates that the TDS of one of the intervals is below 10,000 TDS, the Permittee would not be allowed to inject into it.

**128. One commenter requested that we require the company to prove that the Minnelusa Aquifer and other affected aquifers that now supply drinking water are somehow now deemed not suitable for drinking water or any other competing purpose, such as agriculture and ranching.**

Response #128:

The Class V Area Permit allows injection into the Minnelusa Formation if water samples confirm that it is over 10,000 mg/L TDS in the injection area and a non-USDW. The Safe Drinking Water Act allows injection into non-USDWs because they do not have value as drinking water sources. The UIC regulations do not require operators to further prove unsuitability of the water for competing purposes.

**129. One commenter expressed concern about the calculations made to estimate the radius of fluid displacement, which is an indication of how far from the injection well the waste fluid will move. The calculations were based on a simple model which consider only porosity and thickness of the injection zone. Powertech used a porosity value of 21% and EPA used a porosity value of 10%. Neither are based on site specific data. These analyses did not consider transport of the waste fluid plume by ground water flow. The waste fluid plume will not be static –but will migrate in a downgradient direction once it is emplaced in the injection zone.**

Response #129:

The radius of fluid displacement is a calculation of how far the injectate is expected to move during active injection. It is important to have an estimate of the radius of injectate displacement to consider along with the pressure diffusivity calculation in order to analyze the extent of the injectate location within the aquifer and pressure distribution within the injection zone aquifer. Section 4.4.3 of the Fact Sheet for the draft Class V Area Permit discusses the procedure for the calculation of radius of fluid displacement.

EPA disagrees that Powertech did not use scientific data in its radius of fluid displacement calculation. Logging data from the Minnelusa Formation in the Lance Nelson and the Earl Darrow oil and gas test wells indicated the injection zone thickness was a total 164 feet occurring in three high porosity zones within in the upper 590 feet of the Minnelusa Formation. The porosity measured from the logs ranged from approximately 21% to 33%. Powertech used the more conservative porosity value of 21% in its radius of influence calculation.

EPA also performed the same calculation using a more conservative porosity value based on scientific literature and a longer time estimate for Class V injection activity. EPA performed this calculation in order to provide a more conservative range of the possible extent of the radius of fluid displacement for informational purposes only.

Part II, Section A of the Class V Area Permit requires the Permittee to conduct formation testing in order to acquire site-specific data to use in all of the aquifer-related calculations discussed in the Fact Sheet for the draft Class V Area Permit, including the radius of fluid displacement. The results of this testing and the updated calculations must be submitted to EPA in Injection Authorization Data Package Reports before the Permittee may obtain authorization to commence injection into the Minnelusa. This information must include well logs from the Minnelusa as wells laboratory data from drill hole cores (which will include porosity data), estimates of hydraulic parameters based on aquifer testing, and calculations of critical pressures and injection-induced injection zone pressures for the injection interval based on site-specific information. EPA will review each report, and if EPA determines that the results of the testing do not confirm the information on which the final permit is based, EPA will, as appropriate, require additional testing or modify the permit.

EPA acknowledges that the Class V injectate will flow downgradient from the Dewey-Burdock Project Site in the direction of Minnelusa groundwater flow discussed in response #120. Injection will be authorized in the Minnelusa injection zone only if the Permittee demonstrates the injection zone aquifer is not a USDW. The Minnelusa injection zone increases in depth away from the Dewey-Burdock project site. Generally, due to the depth and poor groundwater quality, the Minnelusa aquifer is an undesirable water source downgradient from the Dewey-Burdock project site. EPA specifically conducted an evaluation of water wells potentially downgradient from the Dewey-Burdock site and found that no water wells were completed in the Minnelusa Formation within about 18 miles downgradient from the site. Based on this evaluation, EPA has determined injection into the Minnelusa Formation at the Dewey Burdock site will not endanger existing water wells.

**130. A commenter asked why the revised Class V permit requires core sampling from the upper confining zone only within the first injection well that is constructed.**

Response #130:

Along with the revised core sampling provision that the commenter refers to, EPA added a requirement that the Permittee must also compare the information gathered from the cores in the first well with logs from subsequent wells to demonstrate the consistency and continuity of the upper confining zone. Because there are a large number of oil and gas test wells that have documented the continuity and thickness of the confining zone overlying the Minnelusa Formation in and near the Dewey-Burdock Project Area, EPA determined the logging information from the subsequent Class V injection wells was adequate in evaluating the Minnelusa Formation upper confining zone, and the requirement for a core sample from the second Class V injection well could be removed without compromising protection of overlying USDWs.

EPA will review the well logs from subsequent Class V wells, which must be submitted with the Injection Authorization Data Package Report required in Part II, Section A of the Class V Area Permit. If the well

logging and core information provided to EPA does not confirm the adequacy of the confining zones at the location of each injection well, EPA will not issue the authorization to inject for that well.

**131. One commenter asserted that the Class V permit application makes no mention of a fault lying within the project area, which is described in Stratigraphic and Structural Controls of Uranium Deposits on Long Mountain, South Dakota, by William A. Braddock, US Geological Survey Bulletin 1063-A, 1957, page 51. Why was the presence of this fault omitted from the application?**

Response #131:

The Long Mountain Structural Zone is mentioned in the Class V Permit Application on page 2-25.

EPA has reviewed the report referenced in the comment. (Braddock, W.A, 1957, *Stratigraphic and Structural Controls of Uranium Deposits on Long Mountain, South Dakota*, USGS Bulletin 1063-A) The areal extent of mapping presented in the body and plates of the report does not overlap with the proposed Dewey-Burdock project boundary. The faults noted in the report occur primarily in Township 7 South, Range 3 East, Sections 18 and 30, about 6 miles east-southeast of the Dewey-Burdock project boundary. Although the Braddock report is not specifically referenced in the Class V Permit Application, similar faulting and other geologic structural features associated with the Long Mountain Structural Zone are identified on Plate 6.24 of the Dewey Burdock Class III Permit application, which is modified from Plate 4 of USGS Professional Paper 763 (Gott et al., 1974).

### **Inventory of Waste**

**132. There is no description of the kind of wastes that might be injected in the Class 5 injection wells, nor toxic metals, so that correct monitoring for potential contamination of downstream private wells could be done.**

Response #132:

The Fact Sheet for the draft Class V Area Permit at Section 7.8 describes the kinds of wastes that are authorized to be injected into the Class V disposal wells. It specifies that Part IV, Section K of the Class V Area Permit restricts the approved injection fluid to waste fluids from the Dewey Burdock project ISR process. These waste fluids include groundwater produced from well construction, laboratory waste fluids, well field production bleed and concentrated brine generated from the RO treatment of groundwater produced from the well field during groundwater restoration. The Final Class V Area Permit clarifies that in addition to these types of fluids, “waste fluids from the Dewey Burdock project ISR process” also includes: restoration bleed not processed by reverse osmosis, yellowcake wash water, bleed from effluent and precipitation circuits, sumps, membrane cleaning solutions, groundwater sweep solutions, and plant washdown water. While most of the groundwater withdrawn from the ISR well field production wells will be reinjected into the well field as part of the ISR and restoration process, there will be a net withdrawal rate, which is referred to as the production or restoration bleed. This bleed will be part of the injectate for the Class V disposal wells.

The Class V Permit only allows injection if water samples indicate that the Minnelusa Formation is a non-USDW at this site. If it is confirmed to be a non-USDW, injection of the approved fluids can occur but only if they meet hazardous waste and radioactive waste standards. Part V, Section D.2 of the Class V Area Permit requires the Permittee to analyze injectate samples quarterly for the analytes in Table 16 to ensure compliance with these standards.

**133. Commenters requested that the Class V Area Permit include uranium as a wastewater monitoring parameter.**

Response #133:

Part V, Section D.2 of the Class V Area Permit requires the Permittee to analyze injectate samples on a quarterly basis for the analytes in Table 16. Uranium is included on this list. The Permit allows injection of fluid containing these constituents, but they must meet the permit limits in Table 16 to ensure that the constituents fall below radioactive and hazardous waste standards.

**134. The wastewater from Dewey Burdock mines will undoubtedly contain an even higher level of organified and unrecoverable uranium than that already documented from other ISL mine sites, because of the open boreholes contaminating the aquifers with micro organisms that are known to organify metals. Other organified toxic metals will also be elevated, increasing the toxicity of such by increased bioavailability and biochemistry in the living body.**

Response #134:

Part V, Section D.2 of the Class V Area Permit requires the Permittee to monitor the ISR waste fluids for the list of analytes in Table 16, which includes a number of metals. The injectate must meet the permit limits for these metals. Regardless of microbial activities that impact metal concentrations in the ISR waste fluids, the Class V injectate must meet permit limits. As discussed in Response #50 above, the analytical methods specified in Table 16 will yield accurate concentrations of metals, even if they are organically bound in the waste fluid.

It is not clear to EPA what the commenter means with regard to the relationship between open boreholes and the contamination of aquifers by microorganisms that are known to organically-bind metals. The commenter may be implying that open boreholes cause a pathway for bacteria from the surface and soil to enter the ore-bearing portions of the Inyan Kara aquifers. Based on literature review, microorganisms that cause uranium and other metals to become organically bound are a very specific type of bacteria and are probably already present within the ore zone areas of the Inyan Kara aquifers.

The commenter does not specify why or how these concerns relate to the Class V Permit conditions. However, EPA would note for that commenter that as discussed in Responses #109, #120, #124 and #239, EPA has determined that Class V injection activities at the Dewey-Burdock site will not impact water wells, USDWs or flow to the surface where humans or animals may ingest it.

- 135. Organically bound metals under this circumstance, and there is plenty of organic carbon naturally existing with ISL mining sites to make this a complication, will continue to increase in the waste water of the ISL mine as they are not recoverable, adding to the metal burden of the wastewater and also the toxicity of such beyond what would be if the metals remained in an in-organic and ionic form.**

Response #135:

The commenter does not specify why or how these concerns relate to the Class V Permit conditions. However, EPA would note for that commenter that as stated in the Response #134 above, Part V, Section D.2 of the Class V Area Permit requires the Permittee to monitor the ISR waste fluids for the list of analytes in Table 16, which includes a number of metals. The Permit allows injection of fluid containing these metals whether they are in an organic or inorganic form, but only if concentrations meet the permit limits in Table 16 to ensure that the constituents meet radioactive and hazardous waste standards. The analytical methods specified in Table 16 will yield accurate concentrations of metals, even if they are organically bound in the waste fluid.

#### **Well Classification/Treatment of Water**

- 136. Some commenters expressed that there was not enough information in the record about Powertech's treatment of waste prior to Class V injection. One commenter noted that although Powertech is required to treat the waste fluid to comply with standards in CFR Part 20, Appendix B, Table II, Column 2 and 40 CFR § 261.24, Table 1 prior to disposal via underground injection, there is little information in the permit application. Another commenter expressed that there is no information regarding the constituents which are expected to exceed the standard and will need to be removed nor any information on how the "radium removal ponds" work. The commenter sought clarification about whether radium is the only constituent that needs to be treated, whether the radium is suspended in the waste fluid and how compliance will be monitored.**

**Finally, commenters claimed that the "airing out" of radon from the waste water via evaporation ponds and then precipitating out the radium with barium chloride does not remove the other radioactive and toxic components and should not qualify as a corrective treatment for radioactive and heavy metal waste into Class V deep injection wells.**

Response #136:

The UIC regulations do not address the treatment of fluids to be injected into the subsurface. Therefore, treatment of fluids prior to injection is outside the scope of the UIC program. The Class V Permit prohibits the injection of any fluids that constitute radioactive waste or contain any constituents that could be defined as hazardous waste, as defined at 40 CFR § 144.3. EPA's UIC program does not regulate how an operator meets those standards, only that they must meet the standards. Per 40 CFR § 144.3, radioactive waste standards can be found at 10 CFR part 20, appendix B, table II, column 2 and hazardous waste constituents can be found at 40 CFR § 261.3. Table 16 of the Class V Permit lists standards that the operator must meet. The permit limits for the Class V injectate are discussed in

Section 7.8.2 of the Fact Sheet for the draft Class V Area Permit. Part V, Section D.2.a of the Class V Area Permit requires the Permittee to collect a sample of the Class V injectate quarterly and analyze for the parameters in Table 16 to determine if the concentrations meet the permit limits for radioactive and hazardous waste.

The treatment ponds are not intended for any “airing out” of radon from the Class V injectate. As stated in Section 7.8.2 of the 2019 Fact Sheet for the draft Class V Area Permit, radium-226 will be treated in settling ponds by adding barium, which will cause the radium to precipitate out of solution. Barium will be added as barium chloride, which reacts with the sulfate present in the ISR waste fluid to form  $Ba(Ra)SO_4$  which precipitates out of solution as a sludge on the bottom of the treatment pond. (Zhang J., et al. 2004, *Barium chloride precipitation-sludge recycle to treat acidic uranium industrial effluent*, in Treatment of liquid effluent from uranium mines and mills. Report of a coordinated research project 1996–2000 Vienna: IAEA-TECDOC-1419, at 89.) The barium chloride treatment process removes 94% of radium from solution. (Ring, R.J., et al., 2004, *Treatment of liquid effluent from uranium mines and mills during and after operation*, in Treatment of liquid effluent from uranium mines and mills. Report of a coordinated research project 1996–2000 Vienna: IAEA-TECDOC-1419, at 15).

In the Class V Permit Application, Powertech stated that uranium will be removed to below permit limits using the ion exchange process. Powertech also provided information about the ISR waste fluid treatment process for radium removal in the radium settling ponds. Radium is the only radionuclide that is expected to exceed radioactive waste limits in the ISR waste fluids. However, as discussed in Section 7.8.2 of the Fact Sheet for the draft Class V Area Permit, if there are other radionuclides present above radioactive waste standards, the Class V Area Permit also requires treatment of the injectate to remove those constituents to meet radioactive waste standards. Similarly, EPA does not expect the eight metals listed in Table 16 to exceed the hazardous waste limits for toxicity, because they are present at such low concentrations in the uranium ore deposits. The Class V Area Permit requires the concentrations for these metals to be measured in the injectate and requires treatment if the concentrations of any of the metals exceed the permit limit.

**137. Commenters asserted that Powertech's wastewater does not qualify as non-hazardous.**

Response #137:

The wastewater to be injected into the Class V wells at the Dewey Burdock site is considered “byproduct material” under the Atomic Energy Act. This wastewater does not qualify as hazardous waste under 40 CFR § 144.3, even prior to treatment and even though it may contain hazardous constituents. The definition of hazardous waste under the UIC regulations adopts the RCRA definition of hazardous waste at 40 CFR § 261.3. “Byproduct material” is specifically excluded from the definition of “solid waste” under RCRA and is therefore excluded from regulation under RCRA. See 42 USC § 6903(27) and 40 CFR § 261.4(a)(4). However, even though this wastewater is not recognized as hazardous waste under the UIC regulations, EPA recognizes it can contain metals that could potentially be hazardous if the concentrations are high enough. The Permit requires that the injectate be below concentration thresholds for hazardous waste and includes standards for potentially hazardous constituents. The



potentially hazardous constituents in the Class V injectate are the eight metals listed in Table 16 which have hazardous waste toxicity characteristic limits found at 40 CFR § 261.24 Table 1.

**138. The disposal of waste, and particularly radioactive waste, below the lower-most aquifer that serves as an Underground Source of Drinking Water (USDW), as proposed here, is not a Class V activity. Rather, such disposal is a Class I underground disposal well. Compare, 40 C.F.R. § 144.80(a) (Class I – deep injection) with 40 C.F.R. § 144.80(e)(Class V – shallow injection). Further demonstrating this fact is the SD DENR which classifies any well that proposes to be used for injection of either hazardous or non-hazardous liquid waste, or municipal waste, as a Class I UIC well. Importantly, the State of South Dakota specifically and unambiguously precludes operation or construction of any Class I UIC wells within its borders. Indeed, the applicable regulatory provision is even broader, stating in its entirety: “Class I and IV disposal wells prohibited. No injection through a well which can be defined as Class I or IV is allowed.” S.D. Admin. R. § 74:55:02:02 (emphasis added). This is a significant issue, which the EPA analysis must address.**

Response #138:

While it is generally true that radioactive waste must be injected into a Class I well that injects below the lowermost USDW (see Prohibition of Class IV wells, 40 CFR § 144.13), the wastewater to be injected under this Class V permit will not be radioactive waste. Radioactive waste is defined at 40 CFR § 144.3. It includes “any waste which contains radioactive material in concentrations which exceed those listed in 10 CFR part 20, appendix B, table II, column 2.” Therefore, any waste that does not exceed these limits is not considered radioactive waste. The Class V Permit prohibits the injection of radioactive waste into the wells. The operator must ensure that the injectate does not exceed the radioactive waste threshold in order to inject into the Class V wells.

Because the waste will not contain radioactive waste (or hazardous waste as explained above in Response #137), it is not required to be injected into a Class I well, below the lowermost USDW. Injection of non-radioactive and non-hazardous waste can be injected above USDWs; when injection is above USDWs and does not fall under Class II, III, IV or VI, it is a Class V injection.

**139. Another commenter pointed out that the disposal would clearly take place above a USDW, the Madison formation, which is a large aquifer of broad use in the Black Hills.**

Response #139:

Class V wells are not limited to inject at a specified depth. Therefore, they are allowed above USDWs. EPA’s role in the issuance of UIC permits is to ensure that the permitted injection activity does not endanger USDWs. In this case, through review of geologic information, EPA determined that there is not a risk of fluid flow from the Minnelusa into the Madison Formation. First, the Lower Minnelusa is comprised of low permeability strata which form the lower confining zone separating the Minnelusa injection zone and the underlying Madison aquifer. EPA has confirmed the thickness and horizontal continuity of the Lower Minnelusa confining zones through observations of oil and gas test well logs in

and around the Dewey-Burdock Project Site. This will again be verified through well logging and testing prior to EPA granting an authorization to inject into each well.

In addition to the confining zone separating the Minnelusa injection zone from the underlying Madison aquifer, the Madison aquifer has a higher hydrostatic pressure than the Minnelusa injection zone aquifer. This means that if there were a breach in the Lower Minnelusa, aquifer fluids would flow out of the Madison aquifer into the Minnelusa instead of into it from the Minnelusa. Evidence of the higher Madison aquifer hydrostatic head is the higher elevation aquifer potentiometric surface compared with the Minnelusa aquifer and the fact that Madison groundwater is moving upward into the Minnelusa, dissolving anhydrite at the dissolution front discussed in Responses #120 and #123 above.

**140. Some commenters expressed concerns about treatment of the wastewater prior to injection. The commenters were skeptical about whether it is possible to treat the wastewater. One commenter raised the “inability to extract radioactive organified metals that are now found in wastewater by ISL in several studies, notably uranium. By regulation, Class 5 waste waters can only be as toxic as storm sewer waters. This wastewater is hardly that. Radioactive organified metals and metallic salts in this wastewater make this waste water unusable for even agricultural purposes, as it would be in this dry uplift area where water is "blue gold", if it were as "pure" as the company says it is. Better technology today shows us the flaws of obsolete testing and regulations today, and why we see such horrid toxicities in Nature at mining sites. The company has not shown any technology that could be effective in processing this wastewater to be safe for a Class 5 well.”**

**Another commenter raised the issue of whether it is possible to treat the water quickly enough to keep up with the injection rate proposed by this project. “There is no analysis or discussion of the reverse osmosis facilities, their location(s) in the project area, or the impacts they would bring. This includes the fact that at least 30% of the water put through the RO process typically becomes waste water. The Class V Fact Sheet uses the number 30% (p. 50), but RO operations can create four gallons of waste water for every 1 gallon of treated water. This waste is commonly called “brine,” although the waste water in this project would be radioactive and full of heavy metals and would require further treatment before being disposed of as 11e waste.”**

Response #140:

As explained above in Response #136, treatment methods for the wastewater are outside the scope of the UIC program. The Permit requires that the injectate meet specific standards, but the UIC program does not dictate how an operator meets those standards.

EPA clarifies that the regulations do not require Class V injectate to be “only as toxic as storm sewer waters.” Class V wells includes all injection not included in the other well classes. Class V wells, unlike other well categories, can be allowed to inject *into* USDWs. However, if they inject into USDWs, they must meet any maximum contaminant limits (MCLs) and otherwise not adversely affect human health. However, if the wells inject into non-USDWs, then the regulations do not specify standards for the injectate.

- 141. There is also the question of whether RO treatment of all this water can be done economically, given the price of uranium (currently only \$19.25 per pound of yellowcake) and other project costs. A responsible agency would include a full discussion of the RO process and its impacts on the environment, waste treatment, bonding requirements, and the feasibility of the project.**

Response #141:

As explained above in Response #136, specification of methods for treatment of the wastewater is outside the scope of the UIC program. This includes any consideration of economic feasibility of the treatment of water. The Nuclear Regulatory Commission (NRC) was required to draft a Supplemental Environmental Impact Statement for the Dewey Burdock project, which included an analysis of the impacts RO treatment. (NRC, 2014) This and other information can be found at: <https://www.nrc.gov/info-finder/materials/uranium/licensed-facilities/dewey-burdock.html> (last visited, October 9, 2020). Section 7.4.1 of EPA's Cumulative Effects Analysis discusses aquifer restoration phase impacts from the deep injection well disposal method and includes information about the RO process in relation to the operation of the Class V injection well disposal process.

#### **Groundwater Flow Direction**

- 142. Additionally, Powertech did its measurement of groundwater flow from East to West (from Dewey-Burdock to Dewey-Burdock Terrace on the Wyoming side of the Black Hills) while the water, according to USGS maps, actually flows from West to East. Powertech and the state of South Dakota seem to entirely disagree with hydrological flows in the application area. EPA should require Powertech to do the correct water flow analysis, from West to East as the correct direction of water flow, and to monitor plumes from the Class 5 wells.**

Response #142:

It is not clear which groundwater-flow analysis is being referenced by the commenter. Potentiometric contours shown in Figure D-14 of the Dewey Burdock Class V Permit application indicate the direction of regional groundwater flow in the Minnelusa generally is to the southeast downgradient from the Dewey Burdock site. Because this figure is reproduced from Figure 8 of USGS Water Resources Investigations Report 01-4129 (Naus et al., 2001), the potentiometric contours shown in the Permit application agree with those shown in the USGS report. Driscoll et al. (2002, Fig. 70) present a modified version of the figure that is annotated with arrows to indicate general directions of groundwater flow based on the potentiometric surface contours of Naus et al. (2001). This figure more clearly indicates the direction of Minnelusa groundwater flow is to the southeast away from the Dewey-Burdock site. Based on the fact there is agreement between the Permit application and the cited reports, and with the commenter, a correction to the flow analysis is not necessary.

The Class V UIC Area Permit does not allow injection into a USDW; the Permittee is only allowed to inject if the Minnelusa is not a USDW in the area. Therefore, there is no need to monitor injectate plumes because the Safe Drinking Water Act does not protect non-USDWs.

### **Number of Wells**

- 143. Commenters question the number of wells authorized under the Class V permit. One commenter requested limiting the number of wells under the Class V permit to 2. Another commenter asserts that most ISL sites only need 1 injection well. Another commenter expresses concern that the EPA documents are misleading because while they discuss two deep disposal wells, the permit actually authorizes up to 4 wells. In this case, the commenter states there might not be any opportunity for public comment on the third and fourth wells. This commenter requests that if the permit is granted it should be limited to the two wells discussed and mapped throughout most of these documents.**

Response #143:

As Section 2.3 of the Fact Sheet for the draft Class V Area Permit describes, the Class V Area Permit authorizes the construction and operation of up to four deep Class V disposal wells within the Class V Area Permit Boundary. The approval of up to four Class V injection wells is based on an evaluation of the geology, planned operating conditions, and proposed well construction. However, the Permittee currently proposes the construction of only one Class V injection well and intends to construct the additional wells only if additional disposal capacity is needed to dispose of the full volume of ISR waste fluids produced. If the Permittee seeks to construct more than the four wells authorized by the permit, they would be required to seek a modification of the existing Class V Area Permit or a new permit for additional wells. In that event, there would be additional opportunity for public review and comment.

### **Concerns About Testing**

- 144. Deep disposal well integrity should be tested at least once per year, not as infrequently as every 5 years. And injectate should be monitored and analyzed regularly, as the characteristics of wellfields will differ, and as the functioning of the RO system may also vary in effectiveness. Records should be maintained until at least five years after the end of the project, in case problems develop over time, not for as little as three years, as the Fact Sheet suggests.**

Response #144:

Class V well requirements in 40 CFR part 146 do not specify frequency of mechanical integrity tests (MIT) because Class V wells broadly include all wells not included in another Class. However, the Class V permit, at Part V, Section C requires external MITs at least once every 5 years. This is consistent with MIT frequency in other well classes, including Class I (40 CFR § 146.13(b)(3)), Class II (40 CFR § 146.23(b)(3)), and Class III (40 CFR § 146.33(b)(3)). In addition, the Class V Area Permit requires continuous monitoring of the tubing-casing annulus pressure to demonstrate internal mechanical integrity. Continuous monitoring will help to quickly identify if there are mechanical integrity issues in the casing or tubing.

The Class V Area Permit requires the injectate to be analyzed quarterly and whenever there is a change in the waste stream.

The records retention requirement is specified by regulation at 40 CFR § 144.51(j)(2) and is incorporated into the Class V Area Permit at Part V, Section E. To clarify, records of the nature and composition of all injected fluids are retained *longer than* three years either by EPA or by the Permittee unless the Permittee obtains written approval to discard the records. The Permit states:

Records of the nature and composition of all injected fluids must be retained until three (3) years after the completion of any plugging and abandonment (P&A) procedures specified under 40 CFR § 144.52(a)(6) The Director may require the Permittee to deliver the records to the Director at the conclusion of the retention period. The Permittee shall continue to retain the records after the three (3) year retention period unless the Permittee delivers the records to the Director or obtains written approval from the Director to discard the records.

**145. DENR recommends EPA evaluate the total dissolved solids (TDS) concentration on a well-by-well basis due to the variability of TDS concentrations in the area and to be consistent with the existing aquifer exemption process for the Class II disposal wells in the vicinity of the proposed project.**

Response #145:

The Class V permit requires the Permittee to sample each well for TDS concentration and submit it to EPA as part of the Injection Authorization Data Package Report. See Class V Permit, Part II, Section A.4.

**146. A commenter expressed concern about ending testing requirements for Class V injection adjacent aquifers. This commenter stated it undermines containment by removing the testing that would identify that it has occurred.**

Response #146:

The Class V Area Permit was revised to remove testing requirements for aquifers overlying the Minnelusa injection zone because the Sundance and other overlying aquifers have already been characterized in the Class III permit application and will be further characterized through requirements in the Class III Area Permit. There is no need to test the overlying Minnekahta Limestone to determine if it is a USDW because it will be protected by cement behind casing as if it is a USDW. Testing of the underlying Madison aquifer still is required if the Madison water supply wells described in the Fact Sheet for the draft Class V Area Permit are constructed. EPA has extensively evaluated information about regional and local geology of the area where the Dewey-Burdock Project site is located and determined there is evidence that adequate confining zones are present to protect USDWs by isolating the Class V Minnelusa injection zone to prevent vertical fluid movement out of the approved injection intervals or zone. Section 3.3 of the Fact Sheet for the draft Class V Area Permit discusses EPA's evaluation of the confining zones.

### Immediate Plugging and Abandonment

- 147. Page 38, Section A- This section states EPA will not approve the plugging and abandonment (PA) of any Class V well until all Class III wellfields have been decommissioned by the Nuclear Regulatory Commission (NRC). DENR recommends EPA revise this section to include the authority to authorize the immediate PA of a Class V well in the event a well loses mechanical integrity or otherwise fails and threatens a USDW.**

Response #147:

If a Class V injection well fails an MIT or a loss of mechanical integrity becomes evident, the permit contains provisions to ensure an expeditious response. Specifically, Part V, Section C.7.a of the Class V Area Permit requires the Permittee to notify EPA within 24 hours and shut-in the well within 48 hours unless EPA requires immediate shut-in. The Permittee must follow up the notification with a written report that documents the circumstances that resulted in the mechanical integrity loss and describe how it was addressed or provide a plan to reestablish mechanical integrity. Injection operations may not resume until mechanical integrity has been demonstrated.

EPA has determined that the existing permit requirements are protective of USDWs in the event of mechanical integrity loss in a Class V well. However, if it is necessary, the UIC Director has the authority to require plugging and abandonment of a well that cannot demonstrate mechanical integrity if the loss of mechanical integrity may cause a violation of primary drinking water regulations or may otherwise adversely affect the health of persons. See 40 CFR § 144.12(c) and (d).

### Seismicity

- 148. Some commenters raised a concern about the possibility of induced earthquakes from the waste-disposal wells needed in the proposed uranium extraction process. They questioned why it is assumed that the proposed wells cannot induce earthquakes, given the presence of relatively soft rock strata and geologic faults within and adjacent to the project area. Commenters also brought up the issue of fracking wastewater disposal in this context. The commenters cited to USGS studies where deep wells used to dispose of wastewater from fracking can cause earthquakes as far as 10 miles from the location of an injection well and noted that the Dewey Fault is only two miles from the proposed well sites. They further noted that the USGS studies demonstrate that injection wells can cause such earthquakes even without the presence of high-pressure injection. Finally, they requested that the EPA clarify whether earthquake risk evaluations developed by the USGS have been applied here.**

Response #148:

EPA thoroughly evaluated the potential for injection-induced seismicity, which is discussed in Section 8.1.2.1 of the Fact Sheet for the draft Class V Area Permit. EPA also reviewed the USGS studies referenced by the commenters. Nothing presented by the commenters alters EPA's conclusion that injection-induced seismicity is not likely and that in the unlikely event it occurs, the Class V permit conditions are adequate to protect USDWs.

EPA has identified three key factors in areas where induced seismicity has occurred: (1) sufficient injection zone pressure buildup from injection activities, (2) a nearby fault, such as a PreCambrian basement fault, and (3) a pathway allowing the increased injection-induced pressure to communicate from the injection zone to the fault. (EPA, 2015, *Underground Injection Control National Technical Workgroup, 2015, Minimizing and Managing Potential Impacts of Injection-Induced Seismicity from Class II Disposal Wells: Practical Approaches*). None of these factors are present at the Dewey Burdock Class V injection wells.

Regarding the first factor, commenters allege that USGS studies demonstrate that injection wells can cause earthquakes even without the presence of high-pressure injection. The reference from the USGS website states: "In operations where engineers pour fluid down the well without added pressure at the wellhead still increase the fluid pressure within the formation and thus can induce earthquakes." This is likely because it is injection rate, as opposed to injection pressure, that is the most important well operating parameter affecting the likelihood of an injection-induced seismic event in areas potentially prone to induced seismicity. (Weingarten et al., 2015, *High-rate injection is associated with the increase in U.S. mid-continent seismicity*, Science, Vol. 348, Issue 6241, pp. 1336-1340.)

Near the Dewey-Burdock Project Area, the Dewey Fault and Structural Zone (discussed in Response #4 above) includes two vertical or nearly vertical faults. The northwestern fault is located 9,375 feet northwest of the proposed location for the Dewey Area Class V deep injection well DW No. 3. The nearest Dewey Area wellfield is located about 7,620 feet from the northwestern Dewey Fault. The USGS reports did not provide a depth for the Dewey Fault. Figure 49 of the Braddock, 1961 report shows cross sections of the Dewey Fault extending into the Spearfish and what is labeled as undifferentiated rocks of pre-Minnekahta age. Because the depth of the fault is unknown, Part II, Section F.2 of the Class V Area Permit requires Powertech to calculate injection-induced pressure within the Minnelusa injection zone and identify an injection rate that will not result in a pressure increase at the Dewey Fault that could result in the Dewey Fault being a conduit for injection zone fluids to migrate to the PreCambrian basement.

Table 21 of the Fact Sheet for the draft Class V Area Permit shows the estimated injection rate for the Dewey-Burdock Class V along with injection rates for wells in areas known for occurrence of injection-induced seismicity. Based on the geologic setting for the Dewey-Burdock Class V injection wells and the anticipated injection rate, EPA concludes there is little likelihood that the Dewey-Burdock deep Class V injection activity will cause injection-induced seismicity. If injection-induced seismicity should occur, it will be detected by the monitoring requirements including under Part V, Section B of the Class V Area Permit and discussed in Section 8.1.2.2 of the Fact Sheet for the draft Class V Area Permit. For additional information about the calculation of injection-induced pressure in the Minnelusa injection zone, please refer to section 4.4.2 of the Fact Sheet for the draft Class V Area Permit.

The second and third key factors in induced seismicity is a nearby fault, like a Pre-Cambrian basement fault, and a pathway allowing the increased injection-induced pressure to communicate from the injection zone to the fault. At this site, the Minnelusa injection zone is located approximately 990 vertical feet above the Precambrian basement at the Dewey-Burdock Project Site. The Lower Minnelusa confining zone isolates the injection zone from underlying aquifers and the PreCambrian basement. Therefore, in this case, there is no pathway between the injection zone and the Pre-Cambrian basement.

The commenters allege a potential for induced earthquakes 10 or more miles away from an injection well and cites to the following USGS website in support: [Are earthquakes induced by fluid-injection activities always located close to the point of injection?](#) (last visited November 9, 2020) This website states: "Given enough time, the pressure increase created by injection can migrate substantial horizontal and vertical distances from the injection location. Induced earthquakes can occur 10 or more miles from injection wells. Induced earthquakes can also occur a few miles below injection wells."

The types of injection wells inducing earthquakes from this distance are oil and gas wells in areas where large volumes of groundwater produced during oil and gas production are disposed of over a long period of time. In these cases, the injection-induced pressure within the injection zone eventually migrates to a Precambrian basement fault location where residual stresses reside in the Pre-Cambrian basement. As injection-induced pressure forces fluids into fault, the fluid acts as a lubricant along the fault plane overcoming the frictional forces that previously prevented movement along the fault. The Dewey Burdock project is very different from these oil and gas operations. Several factors set the Dewey Burdock Class V wells apart from them: the volume of injectate is drastically lower, the injection rates are much lower, and injection at this site will be isolated from the Pre-Cambrian basement.

EPA did review the USGS website that commenters cite to that lists a number of conditions that increase the likelihood of inducing earthquakes (commenters refer to this as "earthquake risk evaluations").

1. Presence of a fault
2. Stresses acting on the fault favorable to slip
3. A pathway for the pressure increase from injection to interact with the fault.
4. High injection rates and/or rapid changes in injection rate.
5. Injection occurring within or close to very hard rocks at depth, known as crystalline basement.

Each of these conditions have been addressed above for the Dewey-Burdock Class V wells and were considered during the development of the UIC permit conditions.

**149. The commenter expressed concern that a potential earthquake at the Dewey Fault, where 440 feet of vertical displacement has already occurred, could disrupt confining zones that are only 20 to 80 feet thick. The commenter also expressed concern that natural or injection-induced earthquakes at or near the site could create disruption of confining strata and mixing of underground water bodies. The commenter stated these scenarios should be addressed.**

Response #149:

EPA reviewed the potential for seismic activity at this site and does not find it likely for either a natural or injection-induced seismic event. As discussed above in Response #148, EPA has concluded that the proposed injection activities at the Dewey-Burdock site is not likely to trigger injection-induced seismicity. With regard to naturally occurring seismicity, EPA reviewed the USGS map that shows the Frequency of Damaging Earthquake Shaking Around the US, which shows the expected number of occurrences of damaging earthquake shaking in 10,000 year ranges from 4 to 10 in southwest South Dakota. ([Introduction to the National Seismic Hazard Maps](#), last visited October 19, 2020). There are no capable faults within the Dewey-Burdock Project Area to cause earthquakes or disrupt the confining



zones. This is discussed further in Response #150 below. Even in the unlikely event that movement occurs along the Dewey Fault, it is too far away to affect the integrity of the confining zones in the project area. Finally, EPA notes that the Dewey fault is located upgradient from the injection well locations, so injectate will be transported away from the Dewey Fault under natural groundwater flow conditions. Since injected fluids will not reach the Dewey Fault and confining zones will remain intact in areas where the injectate flows, EPA does not have any concerns about migration of injection zone fluids into other aquifers.

**150. A commenter stated the permit application fails to address the reasonably foreseeable event of a natural or induced earthquake along the Dewey Fault, which lies only a mile from the project area. The geologic study prepared for the permit application does not employ best current science. For example, the study does not classify the Dewey Fault as a capable fault although it appears to meet at two of the four criteria for a capable fault, only one of which is needed for a fault to be classified as capable. It may meet all four criteria; however, this is difficult to determine because local seismic data are not available to me. (Definition of capable fault can be found here: <https://www.nrc.gov/reading-rm/doc-collections/cfr/part100/part100-appa.html> Earthquakes of greater than 3.0 magnitude have occurred in the immediate area on July 17, 1920, December 30, 1924, and May 3, 1996. A 3.5 magnitude earthquake east of the town of Custer that occurred on December 12, 2013, may have been associated with the Dewey fault. Please explain how it was determined that the Dewey Fault is not capable.**

Response #150:

EPA disagrees that the Dewey Fault meets the definition of a capable fault. The NRC reference provided by the commenter, Appendix A to the NRC regulations at 10 CFR Part 100—Seismic and Geologic Siting Criteria for Nuclear Power Plants, states that a capable fault is a fault which has exhibited one or more of the following characteristics: (1) movement at or near the ground surface at least once within the past 35,000 years or movement of a recurring nature within the past 500,000 years; (2) macro-seismicity instrumentally determined with records of sufficient precision to demonstrate a direct relationship with the fault; or (3) a structural relationship to a capable fault according to characteristics (1) or (2) such that movement on one could be reasonably expected to be accompanied by movement of the other. The NRC stated in Section 3.4.3 of the Supplement Environmental Impact Statement for the Dewey-Burdock Project that “no capable faults (active faults) with surface expression occur within a 62-mile (100-km) radius from the center of the proposed site, demonstrating a historically low seismic potential” and referenced the USGS Quaternary Fault and Fold Database. EPA reviewed this information and agrees with the NRC’s assessment. The Dewey Fault was not included in the USGD Quaternary Fault Database, which means there is no geological evidence there has been movement along the fault since before the Quaternary Period, which began 2.6 million years ago.

See Section 4.10 of the Fact Sheet for the draft Class III Area Permit for additional information on EPA’s evaluation of faults and seismic hazards.

Figure J shows locations of earthquakes that have occurred between 1872 - 2013 in southwestern South Dakota including the earthquakes mentioned by the commenter. This map is available on the [South Dakota Geological Survey website](#).

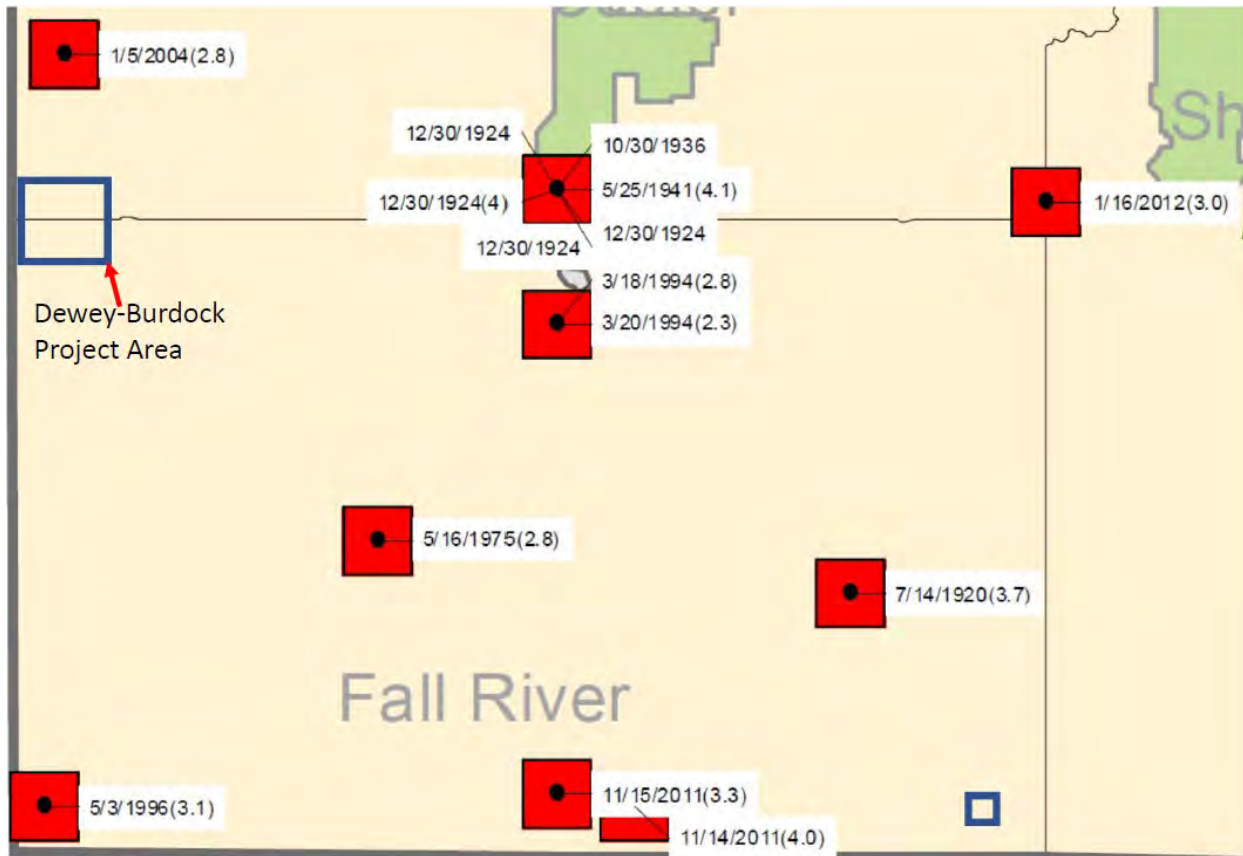

**Figure J. Locations of earthquakes occurring between 1872 – 2013 in southwest South Dakota from the South Dakota Geological Survey website.**

Figure J shows the nearest recorded earthquake to the Dewey-Burdock Project Site is the one that occurred on January 5, 2004, located north of the Project Site. Figure K shows this earthquake location on the [USGS Earthquake Hazards Program interactive map](#). This earthquake was located at latitude 43.598°N and longitude 103.995°W. This location plotted on Google maps with the Dewey Fault zone location added shows that this earthquake was not located in the Dewey Fault zone.

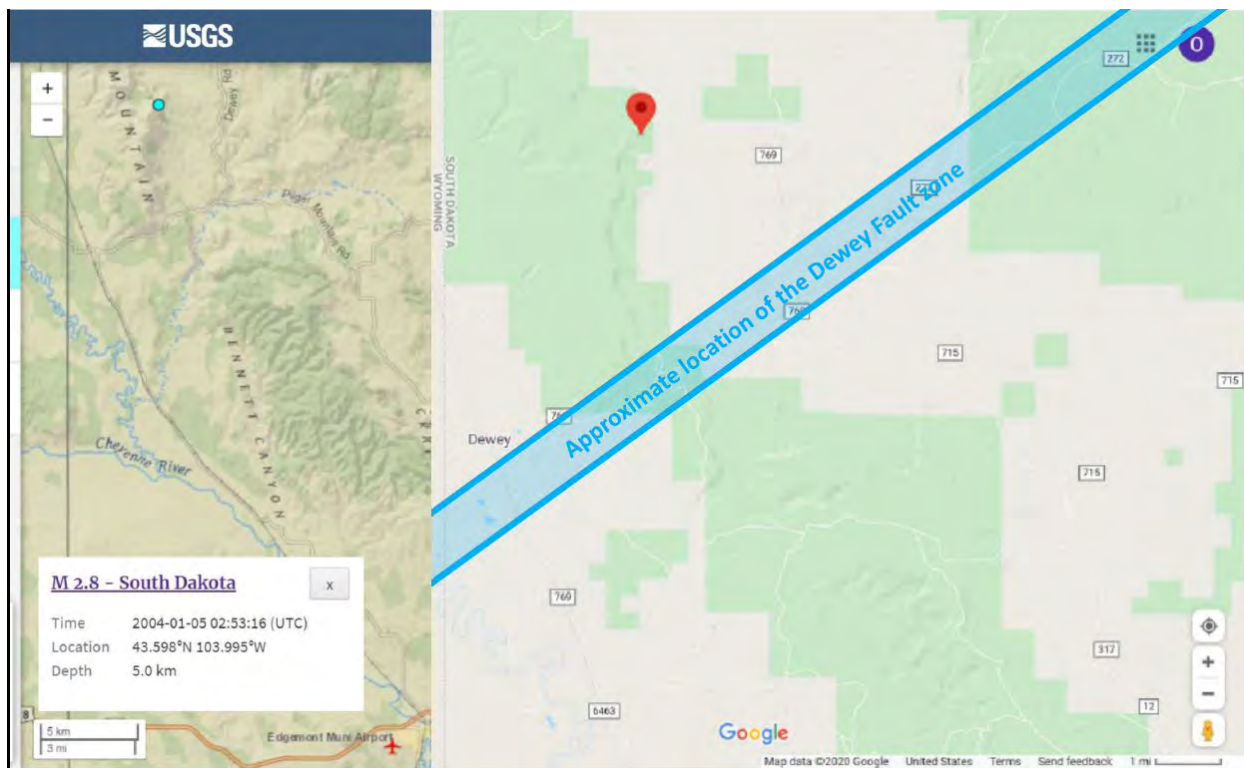

**Figure K. Compilation of the USGS interactive earthquake map and Google maps showing the location of the January 5, 2004 earthquake located at latitude 43.598°N longitude 103.995°W northwest of the Dewey Fault Zone.**

- 151. EPA omits information in its discussion of seismic factors in the Class V Fact Sheet. It states that it is “not aware” of a seismic event causing an injection well to contaminate a USDW or of studies done to determine whether such contamination has occurred (p. 54). It then lists states that have been studied on this issue. The list omits states with injection wells that have been linked – at least in the media -- to seismic incidents, including Oklahoma, North Dakota, and Pennsylvania. The EPA may be “not aware” of some of the research, but it should be held to a higher standard and required to do the relevant research before omitting important information.**

Response #151:

The information in the Fact Sheet for the draft Class V Area Permits referenced by the commenter is from the 2015 EPA Underground Injection Control National Technical Workgroup report entitled *Minimizing and Managing Potential Impacts of Injection-Induced Seismicity from Class II Disposal Wells: Practical Approaches*. At the time the report was issued in 2015, there were no documented cases of groundwater contamination associated with injection induced activity even though Oklahoma had been experiencing an increase in injection induced earthquakes since 2009. In response to this comment, EPA conducted a literature search to identify any studies on groundwater contamination linked to injection induced seismicity and did not find any published technical papers or ongoing studies.

EPA is aware of the incidents of induced seismicity in other states; however, injection induced seismicity has not been linked to groundwater contamination. Additionally, the geologic setting of injection wells is site specific. Injection induced seismicity in other states is not relevant to the Dewey-Burdock Site.

As Section 8.1.2 of the Fact Sheet for the draft Class V Area Permit describes, several factors help to prevent injection wells from failing as a result of a seismic event and contributing to the contamination of an USDW. These include construction with multiple steel strings of casings that are cemented in place in order to withstand significant amounts of internal and external pressure, and mechanical integrity testing to ensure integrity before injection begins and continuous testing to ensure that mechanical integrity is maintained.

Required seismic monitoring will provide an opportunity to pause operations if a detectable seismic event occurs, and the permit contains provisions to ensure an expeditious response. Part IX, Section D.2 of the Class III Area Permit and Part V, Section B of the Class V Area Permit require the Permittee to immediately cease injection and report to EPA within 24 hours if any seismic event of magnitude 4.5 or higher is reported within 2 miles (3.2 km) of the permit boundary. EPA will determine if any testing of the facility infrastructure is required, and the Permittee may not resume injection until it has obtained approval from EPA. For additional information about the evaluation of seismic potential at the Dewey-Burdock site, see Sections 4.10 and 12.8 of the Fact Sheet for the draft Class III Area Permit and Section 8.1.2 of the Fact Sheet for the draft Class V Area Permit.

The commenter did not identify any deficiencies in the Class III or Class V Area Permit seismic monitoring requirements.

**152. We also searched the Class V Fact Sheet looking for a thorough discussion of the seismic characteristics of the proposed mining and injection area. The presence of faults in the immediate area is mentioned (pp. 22-23), but their potential impacts are never analyzed. Similarly in the Class III Fact Sheet, the mechanisms by which Fall River formation water comes up through the Dewey fault is never analyzed (p. 45).**

Response #152:

EPA evaluated information on seismic hazards around the project area and determined that there are no capable faults (as defined in NRC regulations at 10 CFR Part 100) known to be present within 62 miles (100 km) of the project area. The closest capable fault zone to the project area is located nearly 214 miles (345 km) west of the site in central Wyoming. Section 4.10 of the Fact Sheet for the draft Class III Area Permit and Responses #148-151 above present additional information concerning EPA's evaluation of faults and seismic hazards.

EPA is aware of and evaluated artesian conditions within the project area. Groundwater springs commonly occur where artesian conditions (when the aquifer potentiometric level is above ground surface) exist. However, as shown on Figures 4.7 and 4.8 of the Dewey Burdock Class III Permit application, the Dewey Fault does not intersect the project area, so it does not present a concern for the currently proposed for ISR operations. The fact that the fault is located upgradient of the Dewey wellfields and that ISR wellfields are required to maintain an inward hydraulic gradient will prevent ISR injection interval fluids from migrating to the location of the fault. The Class III Area Permit requires full

geologic and hydrologic characterization of each wellfield before EPA will approve injection for ISR operations in a wellfield.

EPA also did review information about the Fall River coming up through the Dewey Fault. Both Gott et al, 1974, and Powertech identified two springs located along the northwest edge of the Dewey Fault. As discussed in Section 4.5 of the 2019 Fact Sheet for the draft Class III Area Permit, Powertech concluded that the springs were flowing from the Fall River aquifer based on water quality analysis. Information from water well completion reports indicate the top of the Fall River is about 80 to 90 feet below the ground surface in this area, but about 550 feet below ground surface on the southeast side of the Dewey Fault. According to the well completion reports, Fall River groundwater is flowing to the ground surface on the northwest side the Dewey Fault. The offset of geologic strata at the Dewey Fault causes the Fall River aquifer on the northwest side of the fault to abut against the relatively impermeable Graneros Group shales on the southeast side of the fault. The Graneros Group shales, acting as a flow barrier, cause an elevation of the Fall River potentiometric surface on the northwest side of the Dewey Fault resulting in flow to the surface at locations where pathways exist. The two springs identified by Gott and Powertech appear to be located along the Dewey Fault and indicate two areas where such pathways exist. However, extrapolating that the entire Dewey Fault serves as a pathway for Fall River groundwater flow to the surface is not supported by evidence in the field or the Tennessee Valley Authority (TVA) pump test in the Dewey Area. According to Boggs, 1983, one of TVA's primary objectives for conducting the Dewey Area pump test was to determine the hydrologic significance of the Dewey fault and its effect on the propagation of groundwater drawdown in the vicinity of the proposed underground mine during the dewatering process. (Boggs, 1983 at 4). Pump test results indicated the Dewey fault zone acts as a hydrogeologic barrier to horizontal groundwater movement through the Inyan Kara aquifers located on opposite sides of the fault zone. (Boggs, 1983 at 21).

**153. No reporting of seismic events <4.0 MMI - As I have mentioned previously in other expert opinions on this subject in this area, I've described seismic events along the Whiteclay Fault (3.1 MMI) that opened previously closed cracks in the bedrock that essentially swallowed up Chadron's surface water supplies (the creek now drains into these cracks) despite being 40 miles from the epicenter. This mistake by the EPA will end up proving all of my opinions on the secondary porosity to be true.**

Response #153:

The commenter inaccurately describes the seismic event reporting requirement in the Permits. Part IX, Section D of the Class III Area Permit and Part V, Section B of the Class V Area Permit require the Permittee to subscribe to the USGS Earthquake Hazards Program email notification service known as the Earthquake Notification Service (ENS), which reports real-time earthquake events for any area specified by the user. The Permittee is required to check daily for notification emails from the service and record any seismic event measuring 2.0 magnitude (MMI scale) or greater occurring within fifty miles of the permit boundary and report such events to the Director on a quarterly basis.

EPA investigated the area referenced by the commenter when evaluating impacts to the Arikaree and Ogallala aquifers. (See Responses #7 and #239). The geologic formations present at the Dewey-Burdock Project Area occurs at depth at the location of the White Clay Fault in northwestern Nebraska. The

surface geological setting of this area is very different from that of the Dewey-Burdock Project Site. Features causing secondary porosity in the area around the Dewey-Burdock Project Area are discussed in Response #7 above. Based on evaluation of this information, EPA does not have concerns about effects of secondary porosity at the Dewey-Burdock Site related to impacts from earthquakes.

**154. A commenter requested clarification about the timeframe for shutting the injection wells and contacting the community following a seismic event.**

Response #154:

If any seismic event of magnitude 4.5 or higher is reported within 2 miles (3.2 km) of the permit boundary, Part IX, Section D.2 of the Class III Area Permit and Part V, Section B of the Class V Area Permit require the Permittee to immediately cease injection and report to EPA within 24 hours. EPA will determine if any testing of the facility infrastructure is required, and the Permittee may not resume injection until it has obtained approval from EPA. EPA clarifies that the UIC regulations do not include requirements for contacting the community following a seismic event; therefore, the Permit also does not include such a condition. If any seismic event of magnitude 4.5 or higher is reported within 2 miles (3.2 km) of the permit boundary, Part IX, Section D.2 of the Class III Area Permit and Part V, Section B of the Class V Area Permit require the Permittee to immediately cease injection and report to EPA within 24 hours. EPA will determine if any testing of the facility infrastructure is required, and the Permittee may not resume injection until it has obtained approval from EPA. EPA clarifies that the UIC regulations do not include requirements for contacting the community following a seismic event; therefore, the Permit also does not include such a condition.

**Limitation on Injectate**

**155. A number of commenters raised concerns about the potential for mining or other types of wastes to be transported from other areas and injected into the Dewey-Burdock Class V wells. The SD DENR recommended addition of a provision stating the permittee is prohibited from injecting fluids received from facilities or operations other than those associated with the Dewey-Burdock Uranium In-Situ Recovery Project.**

Response #155:

Both the 2019 draft Class V Area Permit and final Class V permit specify that the injection fluid is limited to waste fluids from the ISR process generated by the Dewey-Burdock Project. Therefore, the Permittee is prohibited from injecting fluids received from facilities or operations other than those associated with the Dewey-Burdock Uranium In-Situ Recovery Project.

**Powertech Class V Comments Not Addressed in other Responses**

**156. Powertech is not aware that a LAI is an established regulatory process, or is warranted in any way, for the proposed operation. Powertech is not aware that EPA Region 8 has included a LAI requirement for any Class V, Class I, or Class III permit and requests**

**clarification as to why this permit requirement is necessary to protect USDWs, or, absent such clarification, Powertech requests removal of the LAI requirement. The testing procedures that are included under the LAI are routinely done in many similar well permits without a separate authorization, lack any significant potential for contamination of USDWs and are done with well casing in place. Powertech requests moving the Part II, Section A.1 requirements in entirety to Section A.2 (Information to Submit to the Director to Obtain an Authorization to Commence Injection). Further, from an operational standpoint, with the LAI process approval turnaround, drilling operations and equipment will be on standby until the EPA grants the LAI, which will cost Powertech significant resources for no additional protections.**

Response #156:

The Class V Area Permit was revised to remove the “Limited Authorization to Inject” (LATI) process. While in some cases, a LATI is a necessary tool to protect USDWs, in this case EPA agrees that the Permit can provide the same protection to USDWs without this additional step.

Information required for the LATI process under Part II, Section A.1 was combined with requirements for obtaining authorization to inject under Part II, Section A.2. Similarly, requirements for LATI Package Reports described under Part II, Section I were combined with requirements for Authorization to Inject Package Reports under Section K to form updated section J in the Final Permit. Limited injection is permissible prior to receiving authorization to inject only for the purposes of conducting the initial well logs and tests required under Part II. This authorization can be found at Part II, Section I.2 of the Final Permit. The Director will evaluate the information provided in the Injection Authorization Data Package Reports and may issue a written Authorization to inject for each injection zone only after finding that the conditions described in Part II, Section J of the Final Permit have been met.

**157. The Revised Draft Class V Permit states a “Fracture Finder” log will be run. Fracture Finder has different connotations to different people. To clarify, a micro-resistivity log would be an acceptable fracture finder log. A micro-resistivity log uses the same general principals as a normal resistivity (wireline) log, except it is a pad tool with small spacing that allows for very detailed evaluation of the wellbore face and the first 1-3 inches of the formation. It is useful to differentiate between wall cake from drilling mud, filtrate from drilling mud that has invaded the formation, and the formation fluid. It is also useful to identify zones that have significant fluid invasion (such as natural fracture intervals). For this reason, a micro-resistivity log is often referred to as a Fracture Finder log.**

Response #157:

EPA made the requested change to the Class V Area Permit. The term “micro-resistivity” was added in parentheses following “Fracture Finder” in Table 4 for clarification.

**158. Open Hole Sampling: Total Dissolved Solids (TDS) results for samples collected from cased and perforated intervals will inform EPA’s authorization to inject and open-hole logs**

will be used by Powertech to assess formation characteristics and establish perforation intervals. Collecting open-hole samples is therefore not a vital component of well construction and therefore should not be required by the permit. Furthermore, where uncased hole stability presents a risk of hole collapse, collecting open-hole samples may not be achievable. Powertech intends to collect a single cased-hole sample from each injection well unless a confining layer is present between perforated zones where upon samples will be collected from each injection interval isolated by a confining layer. Powertech requests requirements for open-hole aquifer fluid sampling be removed from the permit. In the event open-hole sampling requirements cannot be removed from the permit, Powertech requests the wording be changed to indicate open-hole samples “can be collected at Powertech’s discretion” or “will be collected if practical,” or similar, to provide for the possibility that open-hole sampling may not be achievable. Powertech requests “each discreet Minnelusa perforated interval” in Table 6 of the draft permit and “each Minnelusa injection interval” in Table 12 of the draft fact sheet be defined to mean each perforated zone in the Minnelusa Formation separated by a confining layer. The intent of this definition is to allow a single sample to be collected from across perforated intervals in each injection well in the absence of a confining layer between perforated intervals.

Response #158:

The Class V Area Permit has been revised to indicate the Permittee has discretion to collect open-hole samples in order to provide flexibility for preliminary characterization of injection zones prior to perforating and swab sampling. EPA clarifies that open-hole sampling was included to allow the Permittee the option to characterize the water quality from each aquifer specified in Table 6 of the Class V Area Permit prior to perforating and swab sampling. Collection of open-hole samples is not a vital component of the formation testing program. Permit requirements for cased-hole sampling remain unchanged. To improve clarity and allow a single sample to be collected from across perforated intervals in the absence of a confining layer between perforated intervals, the Permit also has been revised to specify that formation testing described in Tables 6 and 7 and the text in Part II, Section D.2 and D.3 relates to each perforated zone in the Minnelusa Formation separated by a confining layer.

**159. A fluorescent dye tracer is being required to differentiate between drilling mud and formation fluid. Powertech is concerned that maintaining sufficient dye in the system for detection may not be possible. Powertech requests the following be added at the end of II.D.2.a. to address the case where sufficient dye for detection cannot be maintained in the system: “In the event that the dye dissipates in the drilling mud or formation fluid to the extent that it is not detectable during sampling, it is understood that stabilized field parameters will be relied upon to establish the presence of native formation fluid in a given sample.”**

Response #159:

To allow for the possibility that sufficient dye for detection may not be maintained in the system, Part II, Section D.2.a of the Class V Area Permit was revised to include the following text: “In the event that the



dye dissipates in the drilling mud or formation fluid to the extent that it is not detectable during sampling, stabilized values of pH and conductivity during three successive casing volumes may be used to establish the presence of native formation fluids in accordance with Part II, Section 2.d.v.” Although a fluorescent dye tracer provides added assurance that samples are not affected by drilling mud, stabilized values of pH and conductivity are commonly used parameters that also provide suitable indication of representative formation fluids.

**160. Powertech repeats its concern that since the Revised Draft Class V Permit duration is 10 years, it would be appropriate to model the drawdown in the Madison aquifer for 10 years rather than 12 years as currently required. A shorter duration for drawdown modeling is also warranted because the drawdown in the Madison is expected to be minimal with little change over time (Exhibit 001 at 9-10). Similarly, it would be more appropriate to calculate the injection zone formation pressures resulting from 10 years of injection activity rather than 12 years.**

Response #160:

EPA agrees that modeling drawdown in the Madison aquifer and calculating injection zone formation pressures over a period of 10 years is appropriate for the Class V Area Permit, which is issued for a period of 10 years. The Permit was revised to indicate modeling and calculations will be based on a period of 10 years rather than 12 years. Part II, Section F of the Permit also was revised to indicate that if the Permit is renewed or modified for a period longer than 10 years, calculations of critical pressure rise, injection-induced pressure, and maximum injection rate shall be re-evaluated for the revised period of injection, including the effects of drawdown in the Madison aquifer and additional Minnelusa injection wells.

**161. Metals/Radionuclides Sampling**

- i. Are analyses for metals and radionuclides total or dissolved fractions?**
- ii. Why are the analytical methods different from those listed in the Revised Draft Class III Permit (e.g., alkalinity, bicarbonate, sulfate, etc. have different methods in Table 8 of the Revised Draft Class III Permit)?**
- iii. What would be the process for obtaining approval of alternate analytical methods for cased-hole samples?**

Response #161:

Part II, Section D.2 and Part V, Section D.1 have been revised to clarify that, except as may be required by the analytical method(s) shown in Table 8 or Table 14, samples shall be analyzed for dissolved fractions. A footnote also was added to Table 14 to indicate that permit limits for metals and radionuclides are for dissolved fractions. Where applicable, analytical methods presented in Table 8 were revised to be consistent with methods presented in Table 8 of the Class III Area Permit and Table 6.1-1 of the approved NRC license application. Part II, Section D.2 and Part V, Section D.1 have been

revised to indicate that equivalent analytical methods or total recoverable analysis may be used after prior approval by the Director.

**162. Powertech repeats its concern that there is no evidence whatsoever that (a) oil/gas wells or (b) the Dewey Fault are potential conduits for flow from the Minnelusa injection zone to the first overlying aquifer. This characterization is supported by the permit application and the South Dakota DENR Report to the Chief Engineer on Water Permit Application No. 2685-2 (Exhibit 001 at 9, paragraph 1). See Comment #16 in the Original EPA Letter.**

Response #162:

EPA acknowledges that available records for abandoned oil and gas test wells penetrating the Minnelusa Formation in the vicinity of the proposed Class V injection wells list cementing intervals that suggest the wells have been plugged to prevent flow out of the Minnelusa Formation into overlying or underlying USDWs. However, because cement-bond logs or other information could not confirm the location and quality of the cement placement within the wellbore, EPA did not revise Part II, Section F.2.c of the Class V Area Permit to remove the requirement that the Permittee demonstrate that each injection well is located a sufficient distance away from abandoned oil and gas test wells to prevent the potential for movement of fluids into USDWs.

Furthermore, EPA has determined that the hydrologic properties of the Dewey Fault are not sufficiently well characterized to determine the potential for vertical flow through the fault at the depth of the Minnelusa Formation. Although results of aquifer testing provide some indication that the Dewey Fault acts as a barrier to horizontal flow in the Chilson aquifer (Boggs, 1983 at 12), geochemical data presented by Gott et al. (1974) and the presence of springs emanating from the Fall River aquifer along the Dewey Fault northwest of the project area may indicate that some vertical flow is occurring through the fault. These springs are described on page 4-5 and shown on Figure 4.6 of the Class III Permit application. Although the South Dakota DENR Report to the Chief Engineer on Water Permit Application No. 2685-2 states that: “[t]he displacement of the Madison Limestone caused by the Dewey Fault likely provides a north-south groundwater barrier for most of the length of the fault and drawdown from wells south of the fault is not expected to extend to the north of the fault,” no evidentiary support for this statement appears to be provided. EPA further notes that differences in the potentiometric surface between the Minnelusa and Madison 2 miles away from the fault (noted in comment # 16 of Powertech’s original letter) may not reflect potentiometric conditions at the fault or preclude the possibility of limited flow occurring along it. Because the hydrologic properties of the Dewey Fault are uncertain at the depth of the Minnelusa Formation, the Final Class V Permit will maintain the requirement for the Permittee to demonstrate that each injection well is located a sufficient distance away from the Dewey Fault to prevent the potential for movement of fluids into USDWs.

**163. There is no explanation or evidence for the 1,000-foot offset restriction around the pre-existing offset area surrounding plugged oil and gas wells. Powertech has already (conservatively) requested an offset from those wells, even though plugging records clearly indicate that wells are property plugged. There is no basis for EPA to add another**

**1,000 feet to the offset requested in the permit application. Because of records to the contrary, the Earl Darrow #1 well does not serve as a potential conduit for flow, and there are no other oil and gas test wells penetrating the Minnelusa or deeper in the project area. See Comment #17 in the Original EPA Letter.**

Response #163:

EPA clarifies that the 1,000-foot offset required by the Class V Area Permit is not in addition to the offset requested in the application for abandoned oil and gas wells. The required offset is simply 1,000 feet from the wellbore. As indicated in Table 18 of the Fact Sheet for the draft Class V Area Permit, the nearest potential breaches identified near the proposed DW No. 1 injection well are the Earl Darrow #1 oil and gas test well for the Minnelusa upper confining zone and the Sun #1 Lance Nelson oil and gas test well for the Minnelusa lower confining zone. EPA acknowledges that records for the Earl Darrow #1 and Sun #1 Lance-Nelson list cementing intervals that suggest these wells have been plugged to prevent flow out of the Minnelusa Formation into overlying or underlying USDWs. However, because cement-bond logs or other information could not confirm the location and quality of cement placement within the wellbore, EPA did not remove the requirement to determine the maximum injection rate such that the critical pressure in each injection zone is not exceeded 1,000 feet away from the nearest abandoned oil and gas well having a potential breach in the Minnelusa confining zones. Because the hydrologic properties of the Dewey Fault are uncertain (see Response #162 above) and its location is not precisely known at the depth of the Minnelusa Formation, the Final Class V Area Permit also will maintain the requirement for the Permittee to determine the maximum injection rate such that the critical pressure in each injection zone is not exceeded 1,000 feet away from the Dewey Fault.

**164. The permit requirement limits Part II MIT logging to Radioactive Tracer (RAT) logs. Few vendors run RAT logs, and it may be difficult for those vendors to get a license to bring RAT tools into South Dakota. Temperature logs should also be considered.**

Response #164:

EPA agrees that a temperature survey or a radioactive tracer survey can be used effectively to demonstrate external (Part II) mechanical integrity in conjunction with a cement bond log. Therefore, the Class V Area Permit was revised to indicate that either a temperature survey or a radioactive tracer survey may be used to assess baseline and external mechanical integrity..

**165. Powertech requests removing Sections III.D.4.c and III.D.5, since field conditions will dictate cement volumes and casing centralizer spacing. It is inappropriate for the EPA to specify these construction requirements, since Powertech will demonstrate Part II MIT in accordance with the permit and UIC regulations.**

Response #165:

EPA does not agree that it is inappropriate for EPA to specify construction requirements for Class V wells. Consistent with the UIC regulations, EPA must ensure that well construction meets the requirements of 40 CFR § 144.52(a)(1) and is adequately protective of USDWs. This is done by issuing a

permit with appropriate well construction standards. As discussed in Response #39 above, the requirement to use cement in a quantity no less than 120% of the calculated volume to cement off a zone (Class V Permit, Part III, Section D.4.c) is specified by regulation at 40 CFR § 147.2104. Therefore, EPA did not change Part III, Section D.4.c of the Class V Area Permit.

Part III, Section D.5 requires the Permittee to use a float shoe with a float collar one or two joints up from the bottom of the casing and place centralizers at a minimum of one on every fifth casing joint. Powertech stated in the Class V permit application that they anticipate using a float shoe with a float collar one or two joints up from the bottom and that centralizers will be placed a minimum of one every fifth joint. UIC regulations do not specify use of a float shoe, so EPA has reworded this requirement to provide flexibility to the Permittee to use a float shoe and collar as field conditions dictate. Under 40 CFR part 147, subpart QQ, UIC regulations specific to the state of South Dakota, § 147.2104(c) states the owner or operator of a newly drilled well shall install centralizers as directed by the Regional Administrator. EPA has determined that placing centralizers at a minimum of every fifth casing joint is a reasonable requirement, so the requirement for centralizers was not removed. To improve clarity, the centralizer requirement is now a separate provision.

**166. Powertech expressed concerns about well perforations as minor modifications of the permit: The draft permit states certain minor modifications, such as adding perforations within the already approved injection zone, would be major modifications. This appears to be inconsistent with 40 CFR 144.39, which states, “If a permit modification satisfies the criteria in § 144.41 for “minor modifications” the permit may be modified without a draft permit or public review.” § 144.41 allows the Director to change construction requirements pursuant to § 144.52(a)(1) provided that any such alteration complies with the requirements of part 144 and part 146. § 144.52(a)(1) stipulates that “changes in construction plans during construction” may be approved as minor modifications provided that no such changes may be physically incorporated into construction of the well prior to approval of the modification by the Director. Powertech interprets this to mean that perforating in the approved injection zone constitutes a “change in construction plans during construction” because adding perforations in the already approved injection zone is a continuance of well construction within the approved well construction plans. Powertech therefore proposes that the addition of perforations in the approved injection zone should either not require additional approval or should be approved as a minor modification rather than requiring a major modification of the permit. It is common for many UIC well classes that perforations are added within the approved injection zone due to physical plugging, friction loss, or additional porosity discovered through data analysis.**

**Powertech also provided the following comment, similar to that above: The permit indicates any changes in well construction after initial well construction (draft permit) or after well construction is complete (draft fact sheet) will be considered major modifications, including the addition of perforations, according to 40 CFR 144.39 and 40 CFR 124.5. Powertech notes the use of the word “initial” or the phrase “after well construction is complete” are not found in the referenced regulations. Instead, the referenced regulations indicate changes in well construction may be approved by the**

**Director as minor modifications “during construction.” Powertech suggests this provides for minor modifications in well construction at times when construction consistent with approved plans is performed rather than being limited to an undefined “initial” period of construction or after reaching an undefined milestone where “well construction is complete.” Perforating new intervals within the approved injection zone is a continuation of approved well construction. Perforating in the approved injection zone and other construction consistent with the approved plans should therefore be accepted as minor modifications of the permit. Allowable minor modifications [should] include, but are not be limited to, adding perforations in the permitted injection zone and running a liner.**

Response #166:

After reviewing this comment, EPA realized it caused confusion to try and specify whether modifications to the permit would be major or minor. Whether a permit modification may be processed as minor, instead of major, is determined by the regulations at 40 CFR §§ 144.39 and 144.41. Therefore, where the Permits specify that a modification must be major or minor, the provisions were changed to clarify that a change to the condition would require a modification in accordance with 40 CFR §§ 144.39 and 144.41.

EPA agrees that the addition of perforations to an approved injection zone after completing initial construction is consistent with the intended allowable construction specifications and can be included in the approved well construction. Therefore, a provision was added to Part III, Section E (Well Casing Perforations) to clarify that additional perforations may be added to an approved injection zone after initial construction is complete in accordance with Part IV, Section F.3. To be clear, because EPA is including perforations to an approved injection zone as part of the approved well construction standards, there is no need to modify the permit when appropriate perforations are made.

Part IV, Section F.3 (Approved Injection Zone and Perforations) was revised to remove references to major modifications with respect to such perforations and to add the following requirements: 1) The Permittee must provide notice to the Director in accordance with Part III, Section L for well Workovers and Alterations. The Permittee must also follow the requirements for the Injection Pressure Limit found in Part IV Section H, which may result in a change to the permitted MAIP, and 2) Fracture gradient data submitted is representative of the portion of the injection zone to be perforated.

EPA did not, however, include well liners in the approved well construction. Because well liners can take different forms, additional information is needed in order to determine whether they meet regulatory well construction standards. Therefore, the Class V Area Permit has not been revised to include specifications for a liner, and the Permittee will need to use the modification process at 40 CFR §§ 144.39 and 144.41 to request a modification for this purpose.

**167. Powertech repeats its concern that there are several waste streams identified in the Waste Analysis Plan included with the permit application that are not included in the list of waste fluids in the draft permit (e.g., restoration bleed [whether or not it is processed through RO], yellowcake wash water, bleed from effluent and precipitation circuits, sumps, membrane cleaning solutions, groundwater sweep solutions, and plant washdown water).**

Response #167:

While the draft permit did not specifically list “restoration bleed not processed by reverse osmosis, yellowcake wash water, bleed from effluent and precipitation circuits, sumps, membrane cleaning solutions, groundwater sweep solutions, and plant washdown water,” these waste streams fall into the category of “waste fluids from the ISR process generated by the Dewey Burdock Project” described under Part IV, Section K.1 of the draft permit. Therefore, EPA updated the Permit to clarify that these waste streams are also considered “waste fluids from the ISR process generated by the Dewey-Burdock Project.”

**168. See Comment #30 from the Original EPA Letter. Powertech requests that the 4.0 magnitude requirement in the fact sheet and in the second paragraph of V.B. and in V.B.1. of the Revised Draft Class V Permit be changed to a 4.5 magnitude. In addition, for consistency with V.B.4, Powertech requests a 2.0 magnitude be specified in Tables 17A and 17B as shown below.**

Response #168:

Because earthquake magnitudes of 4.0 and 4.5 (MMI) both generally are considered to be classified as “minor to light” (<https://www.usgs.gov/media/images/eq-magnitude-energy-release-and-shaking-intensity-5>; last visited, October 9, 2020) and EPA has determined that the Dewey-Burdock site is in an area of historically low seismic potential as discussed in Section 4.10 of the Fact Sheet for the draft Class III Area Permit, Part V, Section B of the Class V Area Permit has been revised to indicate that if any seismic event of magnitude 4.5 (MMI scale) or greater is reported within two miles of the permit boundary, the Permittee shall immediately cease injection and notify the Director within twenty-four (24) hours. Tables 17A and 17F (updated to 15A and 15F in the Final Permit) also were revised to clarify that monitoring and reporting is required for seismic events greater than or equal to 2.0 (MMI Scale) within a fifty (50) mile radius of the Area Permit boundary.

**169. Powertech notes Table 14 is no longer needed or referenced in the permit because stabilization requirements are stated in II.D.2.g. In addition, Powertech restates its request for modifying Part V, Sections D.1.d, h and i for flexibility as shown below.**

Response #169:

EPA agrees that Table 14 is no longer needed in the Class V Area Permit. The table has been removed. Stabilization criteria from Table 14 for pH and specific conductance (conductivity) have been added to the text of Part II, Section D.2. EPA did not revise Part V, Section D.1.d. to indicate that parameters shall be observed “at the same general time,” as Powertech requested. Simultaneous observation of parameters is a standard permit requirement. Part V, section D.1.h (updated to D.1.f in Final Permit) has been revised to indicate that fluid volumes are to be measured in standard oilfield barrels (bbl) or gallons (gal). Section D.1.i (updated section D.1.g) has been revised to indicate that fluid rates are to be measured in barrels per day (bbl/day) or gallons per minute (gpm). Units for measuring fluid volumes

and rates in Table 17 (updated Table 15) also were revised to include gallons and gallons per minute, respectively.

**170. Please explain the basis for reference to 40 CFR part 146 subpart G, which pertains to Class I hazardous waste injection wells. This permit is not for a Class I hazardous waste injection well; permit conditions prohibit injection of hazardous waste.**

Response #170:

EPA clarifies that the reference in Part V, Section E.2 of the Class V Area Permit to “plugging and abandonment (P&A) procedures specified under 40 CFR § 144.52(a)(6) or under part 146 subpart G, as appropriate” is standard permit language from 40 CFR § 144.51(j)(2)(ii) for conditions applicable to all permits and does not imply the Dewey Burdock Class V Area Permit is for a Class I hazardous waste injection well. To improve clarity, Part V, Section E.2 of the Class V Area Permit has been revised to remove the reference to part 146 subpart G.

**171. Powertech will operate a manned facility. Why are there automated monitoring and shut-off requirements that would apply whether the facility is manned or unmanned? In addition, the monitoring requirements in Part V, Section G.6.h through k apply regardless of manned or remote operations. Powertech requests the addition of a qualifier to indicate that automatic monitoring guidelines must be followed only if the facility is unmanned.**

Response #171:

EPA did not make the requested change to the Class V Area Permit to indicate that automatic monitoring guidelines must be followed only if the facility is unmanned. EPA has determined that whether the facility is manned or unmanned, the requirements for automated monitoring and shut-off devices described in Part V, Section G of the Class V Area Permit are necessary to notify the operator if Area Permit conditions related to minimum or maximum set points are met and to automatically halt injection operations. However, EPA acknowledges that the monitoring requirements that were formerly listed under Part V, Section G.6.h–k (as well as g) would apply regardless of manned or remote operations and are now located accordingly as Sections G.6 through 10 in the Final Permit. Part V, Section G of the Class V Area Permit has been revised to clarify which requirements apply only to remote operations and which apply to both manned and unmanned operations.

**172. Powertech requests that the initial authorization and associated financial assurance estimate is for a single Class V well at the Burdock portion of the site. For each subsequent Class V well, Powertech will update the financial assurance estimate 90 days prior to the start of construction.**

Response #172:

EPA made clear in its Fact Sheet for its 2019 Draft Class V Area Permit (see Section 10.3) that an initial adequate demonstration of financial responsibility (FR) would be required prior to final UIC permit issuance. This is consistent with EPA's UIC regulatory authority found in 40 CFR § 144.52(a)(7), which gives the UIC Director authority to require FR for Class V wells.

### **Financial Responsibility**

**173. Commenters suggested that the financial assurance provided by the Permittee address a variety of activities, including: decontaminating groundwater, providing water to affected residents, addressing contamination caused by fluid movement through boreholes, repairing damages caused by induced seismic activity, and reclaiming the land/addressing damage to agricultural products on soil that becomes contaminated.**

Response #173:

The UIC regulations only authorize EPA to require the Permittee to provide financial assurance to properly close, plug and abandon UIC wells. There are no provisions under the Safe Drinking Water Act or its implementing regulations that would allow EPA to require the Permittee to have financial assurance for other purposes, including the cleanup costs of any potential contamination.

**174. Commenters recommended that the EPA require the Permittee to provide financial assurance before injection activities begin. Some cited examples of cases where operators have gone bankrupt, leaving cleanup costs to be paid with public funds.**

Response #174:

The Class III Permit requires financial responsibility to be in place at the time of permit issuance. The Fact Sheet for the draft Class III Area Permit specifies that EPA will require demonstration of "adequate financial responsibility to cover the plugging and abandonment of planned injection and production wells for the first wellfield to be constructed prior to issuance of the Final Permit." See Section 17.3(2) of the Fact Sheet for the draft Class III Area Permit.

The Class V Permit also requires financial responsibility to be in place at the time of permit issuance. The Permittee has financial assurance in place for one disposal well at the time of permit issuance.

EPA holds a fully funded trust for total secured value is \$929,708, which includes \$133,208 for the one Class V Well in the Burdock Area and \$796,500 for 177 proposed Class III injection wells in Burdock Wellfield 1.

**175. A final issue is the demonstration of financial responsibility by the company, which the Class III Fact Sheet says should be done through a surety bond "or other adequate**



**assurance” (p. 129). The only assurance that should be accepted is an adequate surety bond. The value of the company, if there is any, should not be used to demonstrate financial responsibility.**

Response #175:

Part XIII, Section A.1 of the Class III Area Permit identifies the allowable financial responsibility instruments, which include: a surety bond with a standby trust agreement, a letter of credit with a standby trust agreement, a fully funded trust agreement, or an independently audited financial statement with a Chief Financial Officer’s letter. In the Class V Area Permit, Part VIII, Section A identifies the allowable financial responsibility instruments, which include: a surety bond with a standby trust agreement, a letter of credit with a standby trust agreement, a fully funded trust agreement, or a financial test and corporate guarantee. The permits also specify that the language of the financial instrument match EPA’s model language (which, for the Class III Area Permits is the language specified in the Class I hazardous waste injection requirements at 40 CFR § 144.70). EPA reviewed the financial instrument Powertech submitted to ensure that it is complete, accurate, and adequate and complies with the UIC Program’s financial responsibility requirements. This review is guided by a standard process that EPA has developed to support financial responsibility reviews and evaluate the strength/accuracy of the financial information provided. For additional information about financial responsibility, see Section 17 of 2019 Fact Sheet for the draft Class III Area Permit and Section 10 of the 2019 Fact Sheet for the draft Class V Area Permit.

**176. The definition of an “adequate” surety bond is critical. As noted above, in western South Dakota and elsewhere, it has been common historically for uranium and other mining companies to be unable to fund full restoration after mining, to go bankrupt, and to leave the burden for taxpayers – if restoration was even technically feasible.**

Response #176:

As explained above in Response #173, the UIC regulations only authorize EPA to require financial assurance to properly close, plug and abandon UIC wells. There are no provisions under the Safe Drinking Water Act (SDWA) and its implementing regulations that would allow EPA to require the Permittee to have financial assurance for other purposes, including the restoration of the mining aquifer. The UIC program requirement of ensuring that there is financial assurance to close, plug and abandon the UIC wells is adequate for purposes of the SDWA.

**177. Please fully disclose all bonds or other financial assurances that the various federal, State, Local and/or tribal governments require for the entire Project, under all potential scenarios for potentially permitted actions.**

Response #177:

The Class III and Class V permits require financial assurance to close, plug, and abandon the underground injection in a manner prescribed by the Director. For this project, EPA has secured a fully funded trust agreement as an adequate demonstration of financial assurance by the permittee prior to

final permit issuance. Any financial assurance required by other agencies is outside the scope of EPA's permitting and aquifer exemption actions. Please refer to other agencies with jurisdiction over this project for financial responsibility requirements of their programs.

**178. Powertech notes there are no other ISR projects in Region 8 where financial responsibility has been required to be posted prior to issuance of the final permit; instead, in these other cases, demonstration of financial responsibility has been required after permit issuance but prior to construction. Powertech notes that these new requirements are not standard to other uranium ISR projects in Region 8 and are not required by regulation. Please refer to Comment #59 of this letter.**

Response #178:

The requirement to have financial responsibility in place at the time of final permit issuance is a UIC regulatory requirement for Class III. For Class III wells, the regulations require that *prior to the issuance of a permit* EPA must consider "a certificate that the applicant has assured, through a performance bond, or other appropriate means, the resources necessary to close, plug, or abandon the well as required by 40 CFR 144.52(a)(7)." 40 CFR § 144.34(a)(15).

The UIC regulatory permit language for financial responsibility can be found at 40 CFR § 144.52(a)(7). It specifies that: "[t]he permittee, including the transferor of a permit, is required to demonstrate and maintain financial responsibility and resources to close, plug, and abandon the underground injection operation in a manner prescribed by the Director until . . . ." If financial responsibility were not in place prior to final permit issuance, a permittee would be out of compliance with the permit upon final issuance.

The commenter's reference to other projects is not relevant and is outside the scope of this permitting action.

### **Public Process and Rulemaking Comments**

**179. A few commenters expressed concern about locations of the public hearings. One commenter questioned why there was no public hearing held in Newcastle, Wyoming. Other commenters questioned why there were no public hearings held on nearby reservations.**

Response #179:

In accordance with the regulations, EPA chose to hold several public hearings, at several times and places to facilitate public attendance. See 40 CFR §§ 25.5(c) and 124.12. Following issuance of the first draft permits in spring of 2017, EPA held four public hearings: in Edgemont, SD; Rapid City, SD; Valentine, NB and Hot Springs, SD. EPA selected the locations of the public hearings to ensure that representatives of potentially affected communities had opportunities to participate in public hearings. The City of Edgemont was selected as a public hearing site to be close to potential environmental justice

communities identified using its EJSCREEN online screening and mapping tool (see the EJ Analysis for additional information). The Rapid City, South Dakota location was selected because it is closer to the Cheyenne River Sioux Tribe than the public hearings in Edgemont and Hot Springs; the hearings in Hot Springs provided a venue closer to the western portion of the Pine Ridge Reservation so that Oglala Sioux Tribal members and others could more easily participate; and the hearing in Valentine, Nebraska provided a venue closer to the eastern portion of the Pine Ridge Reservation, the Rosebud Sioux Tribe, the Santee Sioux Tribe, and the Ponca Tribe of Nebraska so that Tribal members and others could more easily participate. EPA held public informational meetings and outreach sessions prior to each public hearing to provide the local communities the opportunity to receive additional information about EPA's proposed actions, and the transcripts of the hearings are available in the docket for the UIC permits.

Following issuance of the second draft permits in August 2019, EPA chose to hold one public hearing in Hot Springs, South Dakota. EPA intentionally held it on a Saturday, outside of the work week, to allow for greater participation.

EPA considered holding one or more hearings on tribal reservations. However, the tribal governments of nearby tribes were not supportive of having the public hearings on their reservations.

**180. Commenters expressed concern that the 5-minute time limit to offer oral comments at the public hearings was too short.**

Response #180:

The regulations allow for a reasonable time limit to be set on oral testimony at public hearings. See 40 CFR § 124.12(c). In this case, EPA allowed for each participant to speak for 5 minutes in order to allow time for everyone to speak. The participants were also given the opportunity to provide written comments and to provide additional testimony after everyone had an initial opportunity to speak at the hearings.

**181. A number of commenters requested an extension of time to submit written comments.**

Response #181:

EPA extended the 2017 comment period for an additional 31 days to June 19, 2017 and the 2019 comment period for an additional 60 days to December 9, 2019 due to the requests.

**182. Several commenters asserted that the EPA needed to promulgate new UIC regulations in order to issue these permits and approve an aquifer exemption. Commenters stated that it was necessary to do this to be in compliance with the Administrative Procedures Act (APA) and Safe Drinking Water Act (SDWA). Some asserted that a rulemaking was especially needed given the controversial impacts of ISL mining and the precedent-setting nature of any new regulations in this area. They asserted that there were "de facto" regulations used to write the permits and aquifer exemption and said that public process**

**is needed in order to comply with the APA. Commenters also asserted that the EPA process was rushed.**

Response #182:

The UIC regulations found at 40 CFR parts 144 to 146 provide adequate authority for EPA's Class III, Class V, and aquifer exemption decisions for this project. The commenters do not specify reasons for their belief that the UIC regulations are not adequate, other than stating that ISL mining is controversial and this is EPA's first UIC ISL uranium issued permit.

The UIC regulations provide explicit authority for issuance of UIC permits for in-situ recovery of uranium. At 40 CFR § 144.6(c), the regulations classify as Class III wells those "which inject for extraction of minerals including: (2) In situ production of uranium or other metals." The UIC regulations further provide specific criteria and standards applicable to Class III wells at 40 CFR § 146.31 to 146.34. While this is the first EPA-issued Class III permit for in-situ recovery of uranium, it is not the first EPA-issued Class III permit for in-situ recovery of other minerals under the SDWA. Additionally, several states have issued UIC Class III permits under EPA's UIC program, using EPA-approved regulations under the SDWA.

The UIC regulations also provide adequate authority for the issuance of a Class V disposal well, and commenters do not specify reasons that the UIC regulations are not adequate. The issuance of a Class V disposal well is not precedential, as EPA has issued other permits for Class V disposal. Similarly, the aquifer exemption regulations at 40 CFR § 146.4 provide adequate authority for EPA's AE decision. The AE decision is also not precedential. EPA has approved a number of AE decisions in the past for purposes of in-situ recovery of uranium.

**183. Commenters raised concern that there has been extensive discussion of the process with the applicant and the uranium industry, resulting in a procedure, guidance, and draft documents. They stated that the draft permit and draft aquifer exemption documents often mimic others, including documents from the applicant, rather than creating a thoughtful analysis of the situation.**

Response #183:

Consistent with the ordinary process for working with permit applicants, EPA has had regular communication with Powertech, but not the uranium industry generally, throughout the application and review process. It is a normal part of the permitting process to communicate with an applicant. It is often necessary to request more information or otherwise seek clarification from the applicant in order to make draft decisions. Neither the Safe Drinking Water Act nor its implementing regulations prohibit this type of communication.

EPA's obligation when reviewing permit applications is to review the required information submitted by the applicant to determine whether an injection activity can be permitted sufficiently to prevent endangerment of USDWs. In this case, EPA reviewed all the necessary information submitted by the applicant in order to draft the permits. Through EPA's independent analysis of all of the required information, EPA proposed permit conditions for the Class III and V permits that would provide adequate protection of USDWs. The commenters do not allege that any of the permit conditions fail to

meet the UIC requirements or that they do not protect USDWs; rather they allege that because the permits and aquifer exemption (AE) Record of Decision (ROD) look like other documents, including documents from the applicant, that EPA did not thoughtfully analyze the information. However, since it is the applicant's duty to provide the information to EPA, the permits will necessarily reflect this information and therefore look like the documents provided to EPA.

**184. A few commenters raised concern about a document that was obtained through a FOIA request on the Dewey Burdock project. The commenters refer to the document as a "guidance" document. The commenters assert that the EPA must engage in rulemaking to promulgate rules regarding the subjects covered in this document. They believe that the document includes policy pronouncements that require notice and comment rulemaking because they assert the document includes "binding norms" that the agency is obligated to apply to future Class III permit applications. The commenters also expressed concern that the EPA communicated with the mining industry and not the public in developing the document, which lacked transparency to the public. Finally, a commenter requested that all documents and records, including all emails, reflecting the coordination between EPA and Powertech and any of its consultants be included in the administrative record for these actions.**

Response #184:

The document referred to by the commenters is titled "Discussion of Zone of Influence, Area of Review, and the Aquifer Exemption Boundary for Class III Injection Wells used for the In-Situ Leaching (ISL) of Uranium." This document is neither a de facto rule nor an agency guidance document. This document was drafted by a Region 8 staff member for purposes of discussion with Powertech and its consultants. Neither of the concepts discussed in this document, the area of review (AOR) or the aquifer exemption (AE) boundary, require additional rulemaking in order to issue permitting or aquifer exemption decisions in the ISL uranium context.

Both the AOR and the AE boundary are site-specific determinations, meaning that EPA must determine them in each instance, based on site-specific factors. The regulation for the AOR can be found at 40 CFR § 146.6. The AOR regulation specifically contemplates that the Director can solicit input from industry in the project area to determine the AOR. See 40 CFR § 146.6. In the case of the Dewey-Burdock project, Region 8 did not solicit input from the general mining industry but did engage in discussions with the applicant and its consultant regarding the AOR. This is a normal part of the application process, as the applicant would have the site-specific information necessary to inform the appropriate AOR. The regulations allow for two different methods to determine the AOR: 1) zone of endangering influence or 2) fixed radius. The zone of endangering influence regulation provides the best description of the AOR. "In the case of an application for an area permit..., the project area plus a circumscribing area the width of which is the lateral distance from the perimeter of the project area, in which the pressures in the injection zone may cause the migration of the injection and/or formation fluid into an underground source of drinking water." 40 CFR § 146.6(a)(1)(ii).

While the commenters express concern about the lack of opportunity for public comment, the public was given an opportunity to provide comments on the chosen AOR in the project, both in the original

permit proposal in 2017 and in the subsequent permit re-proposal in 2019. However, commenters did not provide any specific comments on this issue in the Class III context.

The same is true of the aquifer exemption boundary. There is no need to promulgate additional regulations to determine an AE boundary. The appropriate boundary will be based on the existing criteria in 40 CFR § 146.4 and on site-specific factors related to those criteria. It is both necessary and appropriate for EPA to communicate with the applicant regarding the aquifer exemption boundary, as they have the information necessary to determine the appropriate AE boundary. Following review of the necessary information, EPA proposed the AE with a description of the boundary that the public had opportunity to comment on.

**185. The Tribe asserts that all of the documents and records, including all emails, reflecting the coordination between EPA and Powertech and any of its consultants must be made part of the administrative record for this proceeding, and must be disclosed to the public during the public comment process in order to allow for meaningful public review and comment of the proposed Draft UIC permits. The Tribe submitted several of these documents with the comment letter, which the Tribe believes represents examples of the discussions improperly omitted from the existing public record.**

Response #185:

All communications required to be in the administrative record for the draft permit were included. This includes all communications between EPA and Powertech following submission of its 2013 permit application. These documents were available for inspection during the public comment period to allow opportunity for the public to review and comment on them.

The documents submitted by the Tribe with its comments are communications between EPA and Powertech or its consultants prior to submission of this application. The purpose of these communications with Powertech and its consultants was for EPA to provide technical assistance to Powertech in order to develop complete UIC permit applications, not to acquire information from them to inform a permit decision.

For purposes of a draft permit under § 124.6, the record must consist of:

- (1) The application and any supporting data furnished by the applicant;
- (2) The draft permit or notice of intent to deny the application or to terminate the permit;
- (3) The statement of basis (§ 124.7) or fact sheet (§ 124.8);
- (4) All documents cited in the statement of basis or fact sheet; and
- (5) Other documents contained in the supporting file for the draft permit.

40 CFR § 124.9(b).

The administrative record for final permits includes the draft permit administrative record plus:

- (1) All comments received during the public comment period provided under § 124.10 (including any extension or reopening under § 124.14);
- (2) The tape or transcript of any hearing(s) held under § 124.12;

- (3) Any written materials submitted at such a hearing;
- (4) The response to comments required by § 124.17 and any new material placed in the record under that section;
- (5) Other documents contained in the supporting file for the permit; and
- (6) The final permit.

See 40 CFR § 124.18.

As explained above, the documents submitted by the tribe were communications between EPA and Powertech for the purpose of providing technical assistance to Powertech to develop complete UIC permit applications, not to acquire information from them to inform permitting or aquifer exemption decisions. These communications are not appropriately part of this administrative record.

**186. DENR recommends EPA make the final Injection Authorization Data Package Reports and approval documents for the Class V and Class III permits publicly available on EPA's webpage. And if these drilling activities are actually allowed to proceed, there should be a provision that makes all resulting information public.**

Response #186:

EPA will commit to making the Injection Authorization Injection Authorization Data Package Reports and EPA approval for authorization to inject for the Class V injection wells and Class III wellfields publicly available.

**187. Commenters inquired whether opportunities will be provided to comment on supporting materials, e.g., the Cumulative Effects Analysis or state wildlife agency and federal ESA consultations.**

Response #187:

EPA requested comments on all draft documents during the 2017 and 2019 public comment periods. All supporting materials for the Dewey-Burdock permits and aquifer exemption were available for inspection during the public comment period. The cumulative effects analysis document was available for public review and comment during both comment periods, and the federal Endangered Species Act documents were part of the administrative record during the 2019 public comment period.

### **General Concerns**

A large number of commenters provided comments that lack enough specificity for EPA to respond to. These comments do not identify any specific permit condition(s) of concern or explain how the permits fail to comply with regulatory standards. In the case of aquifer exemption comments, they did not

provide specific comments about the aquifer exemption criteria. However, in the interest of providing information to the public, EPA provides responses below where it is possible to do so.

**188. Many commenters generally expressed concern that there would be environmental pollution from this project – to groundwater, surface water, and other aspects of the environment. These commenters were generally opposed to the project and uranium extraction. Some commenters expressed concern about potential accidental spills and surface leaks. Other commenters claimed that the waste from this project will always be radioactive and cannot be cleaned up. Another commenter claimed there is no way that Powertech/Azarga can guarantee that the mining waste injected into a particular aquifer will stay in that aquifer.**

Response #188:

EPA acknowledges that the public has concerns about the potential for environmental pollution from this project. For those environmental concerns that are not related to underground sources of drinking water, EPA reviewed potential effects in the cumulative effects analysis (CEA) required by 40 CFR § 144.33 and determined that the effects are acceptable. If EPA receives information that effects are not acceptable, it can modify the permit in accordance with 40 CFR § 144.39.

The UIC permitting regulations provide EPA with authority to address endangerment to USDWs in its permits and aquifer exemption decisions. EPA considered potential avenues of contamination to USDWs from the injection activity associated with this project and incorporated measures to address potential migration of contaminants into areas that may endanger USDWs. These permit conditions prevent endangerment to USDWs by ensuring that injection well construction, operation and maintenance, monitoring, and wellfield closure are conducted in compliance with UIC regulations. These conditions address commenters' concern that mining waste injected into an aquifer will not stay there. For additional information on potential impacts to groundwater, commenters can refer to Section 3.0 of the CEA. EPA concluded there will be no impacts to USDWs from the injection activity authorized by the Class III and Class V Area Permits. See also Response #239 below.

Section 4.1 of the CEA discusses the operational surface water monitoring requirements under the NRC License and the SD DENR proposed Large Scale Mine Permit, and the requirements under the NPDES construction and industrial stormwater permits Powertech must obtain before construction activity will be allowed at the site. Section 4.2 discusses the requirements of the stormwater management and erosion control plan Powertech must develop under the proposed Large Scale Mine Permit and EPA's evaluation of impacts to surface water.

The CEA addresses spills and leaks in Section 5.0. Spills or leaks can potentially occur at pipelines, wellfields, processing facilities, deep well pump houses, from transportation accidents, or as releases from treatment and storage ponds. EPA reviewed the proposed requirements in the SD DENR NPDES permits, Large Scale Mine permit, and the NRC license and concluded that they adequately address the short and long-term impacts from spills and leaks that could potentially occur related to drilling and operation of injection wells. These permits include prevention measures, monitoring and mitigation measures for early detection and intervention, and requirements for cleanup of spills and leaks. EPA



concludes that any impacts from potential spills or leaks would be short-term and should not result in exposure to the public above health-based standards. Cleanup requirements will help ensure that there will be no long-term impacts from the spill and leak scenarios that the CEA evaluated.

EPA evaluated radiological impacts, which are discussed in the CEA under Section 5.0, *Impacts from Spills and Leaks*, Section 7.0, *Impacts to Soils* and Section 9.0, *Potential Radiological Impacts and Effluent Control System*. Byproduct material is defined under Section 11e.(2) of the Atomic Energy Act. NRC regulates wastes produced by the extraction or concentration of uranium under the definition of 11e.(2) byproduct material. The NRC license requires any radiological impacts at the Dewey-Burdock Project Site to be fully mitigated before the site is decommissioned.

**189. Many commenters expressed concern about the quality of the Class V injectate and oversight of the quality of liquid wastes pumped into the Minnelusa Formation through the proposed deep disposal wells will be impossible, and groundwater is likely to be contaminated.**

Response #189:

The Class V Area Permit contains permit conditions that address quality of the Class V injectate. Part IV, Section K.1 of the Class V Area Permit restricts the approved injection fluid to waste fluids from the Dewey-Burdock project ISR process. These waste fluids include groundwater produced from well construction, laboratory waste fluids, well field production bleed, concentrated brine generated from the reverse osmosis treatment of groundwater produced from the well field during groundwater restoration, restoration bleed not processed by reverse osmosis, yellowcake wash water, bleed from effluent and precipitation circuits, sumps, membrane cleaning solutions, groundwater sweep solutions, and plant washdown water. The groundwater pumped from any portion of the Inyan Kara aquifers for the purpose of remediating an excursion is also approved for injection into the Class V injection wells.

In Table H-3 of the Class V Permit Applications, Powertech included a list of constituents expected to be in the ISR liquid wastes at the Highland uranium ISR facility in Wyoming in order to provide information of potential constituents and concentrations that could occur in the Class V injectate.

Table 2.7-3. Estimated Flow Rates and Constituents in Liquid Waste Streams for the Highland <i>In-Situ</i> Leach Facility*					
	Water Softener Brine	Resin Rinse	Elution Bleed	Yellowcake Wash Water	Restoration Wastes
Flow Rate, gal/min	1	<3	3	7	450
As, ppm					0.1–0.3
Ca, ppm	3,000–5,000				
Cl, ppm	15,000–20,000	10,000–15,000	12,000–15,000	4,000–6,000	
CO <sub>3</sub> , ppm		500–800			300–600
HCO <sub>3</sub> , ppm		600–900			400–700
Mg, ppm	1,000–2,000				
Na, ppm	10,000–15,000	6,000–11,000	6,000–8,000	3,000–4,000	380–720
NH <sub>4</sub> , ppm			640–180		
Se, ppm					0.05–0.15
Ra-226, pCi/L	<5	100–200	100–300	20–50	50–100
SO <sub>4</sub> , ppm					100–200
Th-230, pCi/L	<5	50–100	10–30	10–20	50–150
U, ppm	<1	1–3	5–10	3–5	<1
Gross Alpha, pCi/L					2,000–3,000
Gross Beta, pCi/L					2,500–3,500

\*NRC. NUREG-0489. "Final Environmental Statement Related to Operation of Highland Uranium"

Metals that have been identified to occur with uranium in the Dewey-Burdock include arsenic, vanadium, selenium, molybdenum, and iron. Part V, Section D.2 of the Class V Area Permit requires the Permittee to monitor the wastewater for 19 separate analytes, including total uranium and natural uranium. The Permittee must monitor the wastewater quarterly and whenever there is a change in the waste stream and report the analytical results to EPA quarterly. If concentrations for any of these parameters exceed EPA allowable limits for toxicity, the injectate must be treated to bring the concentrations down below these limits. Additionally, the Class V Area Permit requires that the injectate be treated to decrease radionuclides to levels below the established limits for discharge of radionuclides to the environment, which are listed in the NRC regulations at 10 CFR Part 20, Appendix B, Table 2, Column 2 (waste streams containing radionuclides below these regulatory limits are not classified as radioactive waste per UIC regulations). The treatment process for radium removal is discussed in Response #136 above.

**190. Commenters assert that there is some ambiguity in the permit conditions that are described in the documents issued for comment as “proposed” measures, and expressed concern that complying with these provisions is at the Permittee’s discretion.**

Response #190:

EPA clarifies that in the draft versions of the permits that were issued for public comment in 2017 and 2019, the provisions were identified as proposed because they did not, at that time, reflect a final permitting determination. Rather, EPA requested comment on draft, proposed conditions in order to consider public input before making final permit decisions. EPA’s final permits reflect enforceable requirements with which the Permittee must comply.

**191. Several commenters generally opposed the exemption of the freshwater Inyan Kara Group aquifers and removal of protection under the SDWA. They expressed concern that this would compromise the safety of the water within these aquifers and allow groundwater contamination that would impact public health or eliminate drinking water resources needed by current and future generations. Several commenters referred to exemptions of the Clean Water Act.**

Response #191:

Response #94 above explains the broad definition of “underground source of drinking water” (USDW) and the aquifer exemption process that allows for aquifers or portions of aquifers to be exempted from the definition of USDW when they really do not have value as a source of drinking water.

Although the Inyan Kara Group aquifers meet the definition of an USDW based on their total dissolved solids (TDS) content, the groundwater contains naturally high levels of radium and gross alpha, and radon levels are high enough that indoor use should be avoided. This is a consequence of being in a formation with commercially producible amounts of uranium. Also, as the aquifer exemption (AE) Record of Decision (ROD) explains, reverse osmosis treatment of Inyan Kara groundwater is necessary to decrease the sulfate concentration below the secondary drinking water standards to make it palatable for human consumption. Therefore, the portions of the aquifers that are exempted would not be considered usable sources of drinking water. EPA also clarifies that the exemption of portions of the Inyan Kara Group is pursuant to the Safe Drinking Water Act, not the Clean Water Act.

**192. The transportation of uranium is a whole other security issue that must be addressed, as are the chemicals used in the extraction process.**

Response #192:

Transportation of uranium is outside the regulatory scope of the UIC Program. EPA cannot write permit conditions in its UIC permits to regulate the transportation of uranium. However, EPA considered this issue and discusses potential impacts from transportation in several scenarios in the Cumulative Effects Analysis document, as well as impacts from spill and leaks. The CEA also discusses the NRC license requirement for the Licensee to develop and implement a spill prevention and cleanup plan to minimize potential impacts to groundwater, surface water and soils, including rapid response cleanup and remediation capability, techniques, procedures, and training.

The comment is not clear about which chemicals are of concern in the extraction process and what it means to “be addressed.” As previously stated, the fluid to be injected into the Inyan Kara Group is a mixture of wellfield groundwater with carbon dioxide and oxygen. The mixture is called “lixiviant.” It will be injected via Class III wells into an exempted aquifer, which is not an underground source of drinking water protected under the Safe Drinking Water Act.

**193. One commenter asserted that the EPA should evaluate the cleanup plans Azarga has in case of any spill, leak and/or contamination.**

Response #193:

The UIC regulations address leaks related to mechanical integrity of the wells and plugging and abandonment plans. The Class III Area Permit includes provisions addressing these concerns. The UIC regulations also authorize EPA to prescribe aquifer cleanup and monitoring where the Director deems it necessary and feasible to ensure adequate protection of underground sources of drinking water (USDWs). These provisions all relate to protection of USDWs. Cleanup plans for other purposes are outside the scope of the UIC program. As discussed in the CEA, the NRC license requires the Licensee to develop and implement a spill prevention and cleanup plan to minimize potential impacts to groundwater, surface water and soils, including rapid response cleanup and remediation capability, techniques, procedures, and training.

**194. Some commenters expressed concern about long term monitoring in 20 or 30 years if wells crack and leak.**

Response #194:

The commenters were not specific about their concerns about long term monitoring and cracks and leaks in wells, so EPA is not able to provide any specific response. The Class III Area Permit requires that wells maintain mechanical integrity. Following operation, wells must be properly plugged and abandoned so that they are not conduits for fluid migration.

**195. The EPA, following Section 2.2.2 of The Unified Guide, described performance standards that Powertech must follow in its statistical analysis of groundwater monitoring data. One of the standards is that, when using a tolerance interval or prediction interval, that interval must be “protective of human health and the environment.” The EPA should know that the science as to what is “protective” when it comes to in situ leach uranium mining is in dispute. There is very little science on the subject, and some of what has been done was completed with improper or inadequate methodology or was paid for by the uranium industry. Before any further steps are taken in working with this process, additional research needs to be completed.**

Response #195:

This comment relates to the downgradient compliance boundary in the 2017 draft Class III Area Permit, which was removed in the 2019 draft. Therefore, this comment is moot. See Responses #21 and #64 above for a discussion of the requirements that replaced the downgradient compliance boundary in the Class III Area Permit.

**196. The conditions are also highly prescriptive, being focused on nuts and bolts activities rather than creating successful outcomes in uranium mining and restoration of ground**

**water. This creates a strong disincentive to innovation and research currently being carried out by the uranium industry and academia, some with EPA funding.**

Response #196:

This comment does not articulate any concern that the permit conditions are not authorized under the Safe Drinking Water Act (SDWA) standards or are otherwise inconsistent with it. The permit conditions are written to comply with the SDWA and its regulations under the underground injection control program.

**197. The EPA documents fail to consider or analyze the relationship between and among heavy metals and relationship to animals, and human bodies. Heavy metals generated from mining are many, and will compromise many essential minerals for health. When one mineral or metal is too high, it will exert a repressive effect upon its counterpart metal or mineral, causing a deficiency or imbalance.**

Response #197:

The comment does not specify concerns about how the Permits do not protect humans from heavy metal exposure. Therefore, EPA cannot offer a specific response to this comment.

**198. Inorganic salts of metals most prominent in aquifers, also have different toxicities, and any monitoring of aquifers should include speciations of these different forms so that proper toxicity evaluation can be done. Simply giving the absolute levels of a metal does not tell the whole story. All metallic “salts” are not equal. They can have different solubilities, different melting points, different Ph, different conductivity affecting the central nervous system that relies on electrical signals, and totally different chemistry within the living body.**

Response #198:

The comment does not articulate specific concerns about the permit conditions. It is not clear if the commenter is asking for lower standards of certain constituents or something different. The SDWA primary drinking water standards for inorganic constituents can be found at 40 CFR § 141.11.

**199. A commenter asked why the EPA reissued the UIC permits in 2019; they also requested clarification about the differences between the 2017 and 2019 versions of the permits.**

Response #199:

EPA made several changes to the UIC proposed Class III and Class V Area Permits, the proposed aquifer exemption Record of Decision and other supporting documents related to these actions in response to comments received during the 2017 public comment period. These changes are listed in a document entitled *Proposed Changes to the Dewey Burdock Underground Injection Control (UIC) Draft Permit*

*Documents (Re-issued August 26, 2019)* that is part of the Administrative Record for the final permit decision. Because the changes to these documents were substantial, EPA decided a second public review process was necessary per 40 CFR § 124.6.

### **Tribal Consultation**

#### **200. A number of commenters stated that the EPA has not conducted adequate tribal consultation.**

Response #200:

EPA recognizes the importance of tribal consultation, and conducted extensive tribal consultation on the proposed Dewey-Burdock uranium in-situ recovery (ISR) site pursuant to the May 4, 2011 “EPA Policy on Consultation and Coordination with Indian Tribes” (EPA Tribal Consultation Policy) (<https://www.epa.gov/tribal/epa-policy-consultation-and-coordination-indian-tribes>) and the “EPA Policy on Consultation and Coordination with Indian Tribes: Guidance for Discussing Tribal Treaty Rights” (EPA Treaty Rights Guidance) (<https://www.epa.gov/tribal/epa-policy-consultation-and-coordination-indian-tribes-guidance-discussing-tribal-treaty>). In summary, EPA notified 38 federally-recognized tribes of the proposed Dewey-Burdock uranium ISR site; offered formal, government-to-government tribal consultation meetings with those tribes; subsequently held tribal consultation meetings with interested tribal governments to receive their input; carefully considered the input received from tribal governments before taking final actions on the UIC permit applications; and is sharing this Response to Comments document with tribal governments as feedback to explain how their input was considered in EPA’s final actions.

As discussed in Response #254, outreach to the tribes began in 2013 after EPA received the complete Class III Area Permit application. Then, on November 25, 2015, EPA sent a letter to 38 federally-recognized tribes listed in Table 2 under Response #253, located in 9 states,<sup>1</sup> offering tribal consultation meetings on the proposed Dewey-Burdock uranium ISR site. In the letter, EPA offered formal tribal consultation on a government-to-government basis concerning the proposed Dewey-Burdock uranium ISR site, including topics such as the permit applications for UIC class III injection wells for use during the uranium recovery process and for UIC class V deep injection wells for disposal of treated ISR process waste water, and potential impacts on the Black Hills. The letter also offered to consult under section 106 of the National Historic Preservation Act concerning potential historic properties, including those of traditional religious and cultural importance.<sup>2</sup> In response, ten tribes requested tribal consultation meetings. EPA scheduled tribal consultation meetings with all ten, and between February and June of 2016 EPA met with and received input from nine of the tribal governments.<sup>3</sup>

---

<sup>1</sup> Colorado, Minnesota, Montana, North Dakota, Nebraska, Oklahoma, South Dakota, Utah and Wyoming.

<sup>2</sup> EPA’s approach to NHPA compliance, including tribal consultation under section 106, is described in our response to comment #262.

<sup>3</sup> EPA held tribal consultation meetings with the governments of the following tribes: Oglala Sioux Tribe; Crow Tribe; Standing Rock Sioux Tribe; Prairie Island Indian Community; Shakopee Mdewakanton Sioux Community;

In March 2017, EPA issued draft UIC permits, a draft Environmental Justice analysis and additional draft documents regarding the proposed Dewey-Burdock uranium ISR site for public review and comment. Subsequently, on June 6, 2017, EPA sent letters to five tribes,<sup>4</sup> all of which had also received EPA's 2015 tribal consultation letter, offering further tribal consultation meetings. EPA offered further tribal consultation meetings to these five tribes because various individual members or government representatives of these tribes had indicated a potential interest in further tribal consultation following EPA's issuance of the draft UIC permits and additional draft documents. In response, one tribe requested a tribal consultation meeting – the Ponca Tribe of Nebraska – and in August 2017 EPA held a tribal consultation meeting to receive input from that tribal government.

After reviewing the public comments it received on the March 2017 draft UIC permits and additional draft documents, and after considering the input it had previously received during tribal consultation meetings with tribal governments, EPA created revised draft UIC permits, a revised draft Environmental Justice analysis and additional revised draft documents. On July 8, 2019, EPA sent a letter offering additional tribal consultation meetings on the proposed Dewey-Burdock uranium ISR site to the same 38 tribes to which it had sent letters in 2015. In its July 8, 2019 letter, EPA offered tribal consultation meetings on topics such as the revised draft permits for UIC class III injection wells for use during the uranium recovery process and for UIC class V deep injection wells for disposal of treated ISR process waste water, the revised draft Environmental Justice analysis, and tribal treaty rights related to EPA's revised draft UIC permits. The letter also offered to consult under section 106 of the National Historic Preservation Act concerning potential historic properties, including those of traditional religious and cultural importance. Subsequently, in August 2019, EPA issued the revised draft UIC permits, revised draft Environmental Justice analysis and the additional revised draft documents for public review and comment. In response to EPA's July 8, 2019 tribal consultation letter, three tribes requested tribal consultation meetings,<sup>5</sup> and in September and November of 2019 EPA scheduled and held tribal consultation meetings to receive input from those three tribal governments.

Additionally, on February 14 and 21, 2020, EPA sent a letter to 15 tribes,<sup>6</sup> following up on EPA's July 8, 2019 letter and reiterating its offer to hold further tribal consultation meetings. Some of the 15 tribes had requested tribal consultation meetings in response to EPA's July 8, 2019 letter but had not yet responded to EPA's attempts to schedule it, while others had not responded to that letter but had previously conducted tribal consultation meetings with EPA concerning the proposed Dewey-Burdock uranium ISR site. In response to EPA's February 14 and 21, 2020 tribal consultation letters, two tribes requested tribal consultation meetings,<sup>7</sup> and EPA held tribal consultation meetings with the Santee

---

Upper Sioux Community; Gros Ventre and Assiniboine Tribes of Fort Belknap; Santee Sioux Tribe; Northern Arapahoe Tribe. EPA also scheduled a tribal consultation meeting with the Cheyenne River Sioux Tribe, but the Tribe later cancelled the meeting.

<sup>4</sup> Ponca Tribe of Nebraska; Rosebud Sioux Tribe; Cheyenne River Sioux Tribe; Oglala Sioux Tribe; Crow Creek Sioux Tribe.

<sup>5</sup> Cheyenne and Arapaho Tribes; Santee Sioux Nation, Nebraska; Cheyenne River Sioux Tribe.

<sup>6</sup> Prairie Island Indian Community in the State of Minnesota; Shakopee Mdewakanton Sioux Community of Minnesota; Upper Sioux Community, Minnesota; Crow Tribe; Fort Peck Assiniboine and Sioux Tribes; Gros Ventre and Assiniboine Tribes of Fort Belknap; MHA Nation; Ponca Tribe of Nebraska; Santee Sioux Tribe; Cheyenne and Arapaho Tribes; Cheyenne River Sioux Tribe; Yankton Sioux Tribe; Oglala Sioux Tribe; Standing Rock Sioux Tribe; Northern Arapahoe Tribe.

<sup>7</sup> Santee Sioux Tribe; Oglala Sioux Tribe.

Sioux Tribe tribal government in July 2020 and with the Oglala Sioux Tribe tribal government in August 2020.<sup>8</sup>

**201. A number of commenters stated that the EPA was required to complete tribal consultation before issuing draft UIC permits for public review and comment, and that the EPA was required to complete tribal consultation before making final permit decisions on the UIC permit applications.**

Response #201:

As explained in Response #200 above, EPA followed the EPA Tribal Consultation Policy, which states that “[c]onsultation is process of meaningful communication and coordination between EPA and tribal officials prior EPA taking actions or implementing decisions that may affect tribes” and that EPA completes tribal consultation by conducting a “follow-up phase” in which “EPA provides feedback to the tribes(s) involved in the consultation to explain how their input was considered in the final action.” In this matter, before issuing draft UIC permits for public review and comment in May 2017, EPA sent a November 25, 2015 letter to 38 tribes notifying them of the opportunity for tribal consultation meetings to provide tribal input to EPA. Between February and June of 2016, EPA held tribal consultation meetings to receive input from nine tribal governments that had requested tribal consultation. As also explained in Response #200, EPA provided multiple additional opportunities for tribal consultation meetings to receive input from tribal governments. Also consistent with the EPA Tribal Consultation Policy, EPA carefully considered the input received from tribal governments before taking final actions on the UIC permit applications, and has concluded tribal consultation by completing the “follow-up phase” by sharing this Response to Comments document with tribal governments as feedback to explain how their input was considered in EPA’s final actions on the UIC permit applications. EPA does not agree that tribal consultation needs to be to be complete prior to issuance of draft permits, and consistent with Response #254, determined there was value in continuing consultation discussions after draft permit issuance so that tribes could engage EPA on specific concerns about permit conditions.

**202. A number of commenters stated that EPA was legally required to comply with tribal government ordinances concerning how to conduct tribal consultation, and that EPA failed to do so.**

Response #202:

As explained in Response #200 above, EPA followed its EPA Tribal Consultation Policy, and conducted extensive tribal consultation. Although the EPA Tribal Consultation Policy does not direct EPA to comply with tribal governments’ tribal consultation ordinances, EPA endeavored to adhere to those ordinances where possible. As one example, the Oglala Sioux Tribe Ordinance 11-10 states that tribal consultation between the Tribe and the United States Government must be initiated by a written request to the Secretary of the Oglala Sioux Tribe. As a result, EPA’s February 14, 2020 letter offering a tribal consultation meeting was sent to the Tribe’s Secretary. While EPA conducted an extensive tribal

---

<sup>8</sup> EPA also scheduled tribal consultation meetings with the Oglala Sioux Tribe on March 23, 2020, June 24, 2020, September 11, 2020 and October 2, 2020, and offered to hold those meetings by telephone or videoconference due to the COVID-19 pandemic, but the Tribe did not accept.



consultation process and completed this process before making final decisions on the UIC permit applications, EPA notes that it does not agree that it is legally required to comply with tribal government ordinances regarding tribal consultation.

**203. Importantly, the EPA's consultation policies commit the EPA to provide further information to the Cheyenne River Sioux Tribe concerning the effect of the Dewey-Burdock Uranium Mine on our resources, to consult pre-decisionally, to honor the Tribe's requests concerning substantive and logistical details of consultation, to involve EPA decision makers in the consultation process, to provide written consultation feedback, and to seek to fully understand and reach a consensus with the Tribe.**

Response #203:

As explained in Response #200 above, EPA followed its EPA Tribal Consultation Policy, and conducted extensive tribal consultation with the Cheyenne River Sioux Tribe and other tribes. Consistent with that Policy, EPA:

- (1) Provided substantial information to tribes about the proposed Dewey Burdock uranium ISR project, during tribal consultation meetings as well as through information attached to EPA's letters offering tribal consultation meetings, and through EPA's public website on the proposed project (<https://www.epa.gov/uic/epa-dewey-burdock-class-iii-and-class-v-injection-well-draft-area-permits-2019>), which contains substantial information including the UIC permit applications, EPA's March 2017 draft UIC permits and related documents, and EPA's August 2019 revised draft permits and related documents;
- (2) Sent letters to the Cheyenne River Sioux Tribe and other tribes in 2015, 2017, 2019 and 2020 offering tribal consultation meetings, and held a tribal consultation meeting with the Cheyenne River Sioux Tribe on September 30, 2019 prior to EPA's final decisions on the UIC permit applications;
- (3) Endeavored to honor the Cheyenne River Sioux Tribe's requests concerning substantive and logistical details of tribal consultation, and for example, per the Tribe's request, held a tribal consultation meeting at the Tribe's reservation on September 30, 2019;
- (4) Involved senior EPA officials in the tribal consultation process; for example, by including the EPA Region 8 Water Division Director, in the September 30, 2019 tribal consultation meeting with the Cheyenne River Sioux Tribe;
- (5) Sought to fully understand the Cheyenne River Sioux Tribe and other tribes' interests and sought to address those interests; and
- (6) Carefully considered the input received from the Cheyenne River Sioux Tribe and other tribes before taking final actions on the UIC permit applications, and is sharing this Response to Comments document with tribes as written feedback to explain how the tribal government input was considered in EPA's final actions.

**204. The Cheyenne River Sioux Tribe believes that consultation must encompass the following at a minimum:**

- **Provide the Tribe with all pertinent information concerning the impact on the Tribe's rights before consultation in a timely manner.**
- **Coordinate with the Tribe before consultation begins, especially with development of an agreement on consultation timelines.**
- **Consult only with Tribal representatives who have been authorized to engage in government-to-government consultation by the Tribal government.**
- **Make every effort to conduct Tribal consultation at the seat of Tribal government, Eagle Butte, South Dakota or elsewhere on the Cheyenne River Sioux Reservation.**
- **Ensure that federal participants in Tribal consultation have actual decision-making authority.**
- **Provide written confirmation that the agency has considered tribal comments and concerns and the agency's response, whether positive or negative.**
- **Obtain resolution of approval from the Tribe that the agency has satisfactorily consulted with the Tribe and the Tribe agrees with the agency's response to Tribal concerns in each instance.**

Response #204:

As explained in Response #200 above, EPA followed its EPA Tribal Consultation Policy, and conducted extensive tribal consultation. Consistent with that Policy, EPA met many of the requests of the Cheyenne River Sioux Tribe (Tribe) in this comment. EPA:

- (1) Provided substantial information to the Tribe about the proposed Dewey Burdock uranium ISR project, during tribal consultation meetings as well as through information attached to EPA's 2013 letter offering consultation under the National Historic Preservation Act and attached to EPA's 2015, 2017, 2019 and 2020 letters offering tribal consultation meetings, and through EPA's public website on the proposed project (<https://www.epa.gov/uic/epa-dewey-burdock-class-iii-and-class-v-injection-well-draft-area-permits-2019>), which contains substantial information including the UIC permit applications, EPA's March 2017 draft UIC permits and related documents, and EPA's August 2019 revised draft permits and related documents.
- (2) Coordinated with the Tribe beginning in 2013, before initiating tribal consultation, to discuss the proposed Dewey Burdock uranium ISR project.
- (3) Contacted the Tribal Chairman in EPA's 2015, 2016, 2017, 2019 and 2020 letters offering tribal consultation meetings, and contacted tribal government representatives on many other occasions to offer tribal consultation meetings, for which the Tribe could select the proper tribal government representatives.
- (4) Held a tribal consultation meeting at Eagle Butte, South Dakota on the Cheyenne River Sioux Reservation.

- (5) Involved senior EPA officials in the tribal consultation process; for example, by including EPA Region 8 Water Division Assistant Regional Administrator in the September 30, 2019 tribal consultation meeting with the Tribe.
- (6) Carefully considered the input received from the Tribe before taking final actions on the UIC permit applications and is sharing this Response to Comments document with the Tribe as written feedback to explain how the Tribe's input was considered in EPA's final actions.

**205. A number of commenters stated that EPA was required to hold tribal consultation meetings on tribes' reservations, which some tribes requested.**

Response #205:

As explained in Response #200 above, in this matter, EPA followed its EPA Tribal Consultation Policy. EPA offered to all tribes the opportunity to have in-person tribal consultation meetings and held tribal consultation meetings on the reservations whenever tribes requested. The only exception to this was due to the COVID-19 pandemic. The EPA Tribal Consultation Policy allows for a variety of methods for tribal governments to communicate their input to EPA: "[The Input Phase] may include a range of interactions including written and oral communications including exchanges of information, phone calls, meetings, and other appropriate interactions depending upon the specific circumstances involved." EPA's "Tribal Consultation Implementation: Frequently Asked Questions" (<https://www.epa.gov/tribal/tribal-consultation-implementation-frequently-asked-questions-faqs>) states that "[t]he consultation process is flexible and tailored to the specific needs of EPA, tribes, and the issues involved. Some consultations may involve multiple communications between EPA and tribes, potentially including workshops, webinars, teleconferences, or face-to-face meetings." It further states:

16) How does EPA determine if a consultation will be a teleconference or a face-to-face meeting? The Policy is intentionally designed to accommodate a diverse range of tribal consultation needs and preferences. The specific form of any given consultation is influenced by a variety of factors including, but not limited to, the issues being considered, number of tribes potentially affected, time and resource limitations of EPA and involved tribes, and other pertinent factors. While EPA appreciates the benefits of face-to-face consultations, EPA is not able to have such consultations in all instances.

**206. Tribal consultation, which is a government to government consultation between tribal governments and the United States government, requires the presence of cabinet level members of both the tribal and United States governments.**

Response #206:

As explained in Response #200 above, in this matter, EPA followed its EPA Tribal Consultation Policy. Consistent with the EPA Tribal Consultation Policy, senior EPA managers of EPA's Region 8 office in Denver, Colorado, oversaw the tribal consultation meetings, and directly participated in many of them but EPA notes that it does not agree that cabinet level members of the United States government are required to participate in the EPA tribal consultation process.

**207.** "In carrying out its treaty obligations with the Indian tribes, the Government is something more than a mere contracting party." *Seminole Nation v. United States*, 316 U.S. 286, 296-67 (1942). Instead, "it has charged itself with moral obligations of the highest responsibility and trust." *Id.* Pursuant to its trust duty, agencies are required to "consult with Indian tribes in the decision-making process to avoid adverse effects on treaty resources." *Klamath Tribes v. United States*, No. 10-2130, 1996 WL 924509 (D. Or. Oct 2, 1996) (quoting *Lac Courte Oreille Band of Indians v. Wisconsin*, 668 F. Supp. 133, 140 (W.D. Wis. 1987); *Ctr. for Biological Diversity v. Salazar*, No. 10-2130, 2011 WL 60000497, at \*11 (D. Ariz. Nov. 30, 2011). It is not a discretionary duty. *Ctr. for Biological Diversity*, at \* 11.

Response #207:

EPA conducted extensive tribal consultation pursuant to the EPA Tribal Consultation Policy, and EPA Treaty Rights Guidance, as explained in Response #200 above.

**208.** The duty to consult is binding on an agency when the agency has announced a consultation policy, and the Tribes have come to rely on that policy. *Yankton Sioux Tribe v. Kempthorne*, 442 F. Supp. 2d 774, 784 (D. S.D. 2006); see also *Oglala Sioux Tribe v. Andrus*, 603 F.2d 707 (8th Cir. 1979); *Lower Brule Sioux Tribe v. Deer*, 911 F. Supp. 395 (D. S.D. 1995); *Albuquerque Indian Rights v. Lujan*, 930 F.2d 49, 58 (D.C. Cir. 1991); *Indian Educators Fed'n Local 4524 of Am. Fed'n of Teachers, AFL-CIO v. Kempthorne*, 541 F. Supp. 2d 257, 264-65 (D. D.C. 2008). At a minimum, this requires that the agency give fair notice of its intentions, which requires, "telling the truth and keeping promises." *Yankton Sioux Tribe*, 442 F. Supp. 2d at 784 (citing *Lower Brule Tribe*, 911 F. Supp. at 399). An agency's failure to provide tribes with accurate information necessary to meaningfully consult before a decision is made is agency failure to meet its consultation obligation. *Id.* at 785; see also *Cheyenne River Sioux Tribe v. Jewell*, No. 3:15-03072, 2016 WL 4625672 (D. S.D. Sep. 6, 2016). Reviewing a Tribe's comments submitted in conjunction with an agency's general invitation/or public comments is not sufficient to meet this obligation.

Response #208:

As explained in Response #200 above, EPA conducted extensive tribal consultation pursuant to the EPA Tribal Consultation Policy, and EPA Treaty Rights Guidance, including giving notice to 38 tribal governments of its obligation to act on UIC permit applications concerning the proposed Dewey Burdock uranium ISR site, and providing substantial information such as the UIC permit applications, draft UIC permits and related draft permitting documents. As also explained in Response #200, EPA conducted tribal consultation that was separate from the general public's review of and comment on draft UIC permits and related draft permitting documents.

**209. A number of commenters stated that EPA “inform and educate” meetings with tribes did not constitute adequate tribal consultation.**

Response #209:

As explained in Response #200 above, EPA conducted extensive tribal consultation pursuant to the EPA Tribal Consultation Policy, and EPA Treaty Rights Guidance. This tribal consultation was separate from EPA “inform and educate” meetings that EPA presented to tribal governments, such as those in August 2015 in which EPA provided information about the proposed project scope, and during which EPA requested information and feedback regarding the proposed project area, tribal interests, and additional information that tribal governments wanted as EPA prepared for tribal consultation.

**210. A number of commenters stated that tribal consultation must influence EPA’s decisions on the UIC permit applications.**

Response #210:

As explained in Response #200 above, EPA followed its EPA Tribal Consultation Policy, and conducted extensive tribal consultation. Consistent with that Policy, EPA carefully considered the input received from tribal governments before taking final actions on the UIC permit applications and is sharing this Response to Comments document with tribal governments as written feedback to explain how their input was considered in EPA’s final actions. For example, after receiving input from tribal governments expressing concern that the UIC Class III area permit would not be sufficiently protective of underground sources of drinking water, EPA added a number of permit conditions to further enhance protection of underground sources of drinking water, including requiring the following: increased sampling frequency for two additional monitoring wells during a confirmed excursion; excursion monitoring during the stability monitoring phase for restored wellfields; fifteen additional analytes included on EPA water quality parameter list; identifying and monitoring expanding excursion plumes; geochemical modeling to evaluate the potential for ISR contaminants to endanger USDWs; and increased frequency for operational monitoring of downgradient private wells.

**211. A number of commenters stated that EPA is legally required to comply with the tribal consultation requirements of Executive Order 13175 and a Presidential Memorandum dated November 5, 2009 concerning the implementation of Executive Order 13175.**

Response #211:

As explained in Response #200 above, EPA conducted extensive tribal consultation pursuant to the EPA Tribal Consultation Policy, and the EPA Treaty Rights Guidance. The EPA Tribal Consultation Policy states that the policy:

“complies with the Presidential Memorandum (Memorandum) issued November 5, 2009, directing agencies to develop a plan to implement fully Executive Order 13175 (Executive Order). The Executive Order specifies that each Agency must have an accountable process to

ensure meaningful and timely input by tribal officials in the development of regulatory policies that have tribal implications.”

EPA conducted extensive tribal consultation pursuant to the EPA Tribal Consultation Policy, and the EPA Treaty Rights Guidance, which complies with the November 5, 2009 Presidential Memorandum to implement Executive Order 13175.

### Tribal Treaty Rights

**212. A number of commenters stated that Article VI of the United States Constitution states that “Treaties ... shall be the supreme Law of the Land;” that tribes own the Black Hills and the project area, including corresponding mineral rights, pursuant to the Fort Laramie Treaties of 1851 and 1868, earlier treaties and aboriginal claims; and that granting the UIC permits without tribal approval violates these treaties.**

Response #212:

EPA recognizes that the U.S. Constitution defines treaties as part of the supreme law of the land, with the same legal force as federal statutes.

Regarding comments asserting that tribes still own the Black Hills and its corresponding mineral rights (including the project area) pursuant to the Fort Laramie Treaties of 1851 and 1868, earlier treaties and aboriginal claims, EPA is not aware of any federal court decision affirming those assertions. In contrast, federal courts have held that the boundaries of tribal lands recognized by the Fort Laramie Treaty of 1851 (11 Stat. 749 (1851)) were reduced by the Fort Laramie Treaty of 1868 (15 Stat. 635 (1868)), and the treaty lands established pursuant to the Fort Laramie Treaty of 1868 were reduced by the Congressional Act of February 28, 1877 (19 Stat. 254 (1877)). In describing the 1877 Act, the United States Supreme Court stated, in *United States v. Sioux Nation of Indians*, 448 U.S. 371, 382-83, 423 (1980): “[t]he Act had the effect of abrogating the earlier Fort Laramie Treaty [of 1868], and of implementing the terms of the Manypenny Commission’s ‘agreement’ with the Sioux leaders,” and that “the 1877 Act, in addition to removing the Black Hills from the Great Sioux Reservation, also ceded the Sioux’ hunting rights in a vast tract of land extending beyond the boundaries of that reservation.”

Further, the Supreme Court stated that “in exchange for the benefits conferred by the [1868 Treaty of Fort Laramie], the Sioux agreed to relinquish their rights under the Treaty of September 17, 1851, to occupy territories outside the reservation....” *Id.* at 375. Also, the Federal Court of Claims has evaluated arguments that signatory tribes to the Fort Laramie Treaty of 1868 retained rights in lands outside of the reservations and off-reservation hunting rights explicitly preserved in that treaty, but held that the tribes relinquished all rights in their lands except those granted in the treaty. *United States v. Sioux Tribe*, 616 F.2d 485, 487-91 (Ct. Cl. 1980).

One comment stated that the Teton and Yanktonai Sioux Divisions (bands) claim title to fourteen million acres of non-treaty (aboriginal title) lands between the Missouri River and James River in North Dakota and South Dakota. Those lands are far to the east of the project area and are not implicated by EPA’s final UIC permit approvals, and EPA notes that a federal court has held that those lands were ceded to

the United States by the Fort Laramie Treaty of 1868. *Sioux Tribe v. United States*, 500 F.2d 458, 470-72 (Ct. Cl. 1974).

EPA is aware of continued claims by tribes to land ownership of the Black Hills and the project area subject to the Fort Laramie Treaty of 1868, tribes' disputes of the Supreme Court's decision in *United States v. Sioux Nation of Indians*, 448 U.S. 371 (1980), as well as other longstanding treaty disputes between tribes and the United States. In its role as a regulatory agency, EPA lacks the authority to resolve these disputes.

**213. A number of commenters stated that title to the Dewey-Burdock project area remains disputed by tribes. In the case of *United States v. Sioux Nation of Indians*, 448 U.S. 371,387 (1980), the United States Supreme Court ruled that the taking of Sioux Nation treaty lands under the Act of February 2, 1877 and other laws violated the 5th Amendment of the United States constitution, and affirmed a judgment of \$108 million. Tribes have not accepted the award of money damages, and have continuously insisted that land restoration be the cornerstone of a settlement of the outstanding Treaty claims under the 1851 and 1868 Treaties. As explained by South Dakota District Judge Lawrence Piersol, "If there is to be any other resolution for these past wrongs ... then (it) must come from Congress." (*Different Horse v. Salazar*, Civ. 09-4049, Memorandum Op. and Order p. 9, (D.S.D. 2009)).**

Response #213:

Please refer to Response #212 above.

**214. The aquifers subject to the EPA's proposed UIC aquifer exemptions belong by treaty to the Lakota Sioux people.**

Response #214:

Please refer to Responses #212 above and #215 below.

**215. A number of commenters stated that the Dewey-Burdock uranium mine would contaminate waters such as the Cheyenne River, and other reservation and off-reservation waters, in violation of aboriginal tribal water rights and tribal water rights reserved pursuant to treaties with tribes, such as the Fort Laramie Treaties of 1851 and 1868.**

Response #215:

As described in more detail below, EPA has concluded that underground injection pursuant to the UIC permits will not result in water quality impacts to groundwater, surface water or wetlands within or underlying formal Indian reservations or other tribal lands, which are outside the project area. Also as described in more detail below, EPA has concluded that underground injection pursuant to the UIC

permits inside the project area will have minimal water quality impacts on the Inyan Kara aquifer and no effects on USDWs in the Minnelusa formation. Potential impacts from non-injection ISR operations are also discussed below.

Impacts to groundwater or surface water outside of the project area, including on or beneath Indian reservations and other tribal lands

EPA notes that the project area is not located on a reservation. The closest formal reservation to the project area, the Oglala Sioux Tribe's Pine Ridge Indian Reservation, is over 40 miles away, and aside from formal reservations, the closest land held in trust for the benefit of tribes by the United States government appears to be the Pe' Sla property, which is located over 30 miles away.<sup>9</sup> After carefully considering these comments, EPA has concluded that ISR operations pursuant to the UIC permits will not result in water quality impacts to groundwater, surface water or wetlands within or underlying formal Indian reservations or other tribal lands. More specifically, EPA has concluded that: (1) ISR operations pursuant to the Class III UIC permits, including but not limited to underground injection pursuant to the UIC permits, will not result in water quality impacts to groundwater outside of the aquifer exemption area of the project area; (2) ISR operations pursuant to the Class V UIC permits, including but not limited to underground injection pursuant to the UIC permits into the Minnelusa aquifer, will not result in water quality impacts to any aquifer other than the Minnelusa, within the Minnelusa will not result in water quality impacts to USDWs, and in particular will not result in water quality impacts to Minnelusa aquifer groundwater beneath the Pine Ridge and Cheyenne River Reservations; and (3) ISR operations pursuant to the UIC permits, including but not limited to underground injection pursuant to the UIC permits, will not result in water quality impacts to surface water or wetlands on formal Indian reservations or other tribal lands outside the project area.

*Groundwater impacts*

Class III Injection - In Sections 3.3, 3.3.1, 3.3.2, and 3.3.3 of EPA's Cumulative Effects Analysis (CEA), EPA concluded that there will be no impacts from Class III injection to groundwater quality outside the aquifer exemption boundary within the Inyan Kara aquifers, or any impacts to any other aquifers.

Class V Injection - Regarding potential impacts from Class V injection, EPA added a new section 3.3.6 to the CEA titled "Impacts to USDWs from Class V Injection Activity." Based on EPA's evaluation of the geologic information and the protective permit requirements in the Class V Area Permit, EPA concludes that there will be no groundwater quality impacts from authorized Class V deep well injection activities to the Madison aquifer or any other aquifer except the Minnelusa, and within the Minnelusa will not result in water quality impacts to USDWs. Further, in Response #239 below, EPA discussed groundwater flow in the Minnelusa injection zone from the Dewey-Burdock project site to the Pine Ridge and the Cheyenne River Reservations and concluded that any fluids injected via the Class V wells would take over 100,000 years to reach the Minnelusa aquifer beneath the Pine Ridge and Cheyenne River Indian Reservations and would not have an impact on the water quality at these sites.

---

<sup>9</sup> The Pe' Sla property is located in the Black Hills, and is held in trust by the United States Government for the benefit of the Rosebud Sioux Tribe of the Rosebud Indian Reservation, South Dakota; Shakopee Mdewakanton Sioux Community of Minnesota; Crow Creek Sioux Tribe of the Crow Creek Reservation, South Dakota; and the Standing Rock Sioux Tribe of North & South Dakota.



Non-injection ISR operations - In addition to EPA's analysis of potential impacts from injection activities, the CEA also concludes that any impacts to groundwater from non-injection ISR operations, such as storage ponds or spills and leaks, will not result in any long-term effects and should not result in exposure to the public above health-based standards.

#### *Surface water impacts*

Class III and Class V Injection - EPA also analyzed potential impacts to surface water, including wetlands, from Class III and Class V injection. Section 4.8 of the CEA states that "EPA has concluded there will be no surface water impacts from Class III injection activities to surface water and wetlands, and specifically to the Cheyenne River and other downstream communities along the Cheyenne River." Regarding Class V injection activities, section 4.7.1 of the CEA states that "EPA does not expect any impact to surface waters and wetlands from injection into the Minnelusa aquifer at the Dewey-Burdock Project Site."

Non-injection ISR operations - The primary source of potential surface water impacts from activities other than drilling and injection are those related to the general operation of the project. In particular, surface water impacts could result from impacts from land application of wastewater and discharges of stormwater during construction and operation of the facility. South Dakota's Large Scale Mine Permit regulates land application of wastewater, and stormwater discharges are regulated through the South Dakota's construction and industrial stormwater Clean Water Act National Pollution Discharge Elimination System (NPDES) general permits. South Dakota's Large Scale Mine Permit and construction and industrial stormwater permits include requirements that permittees not cause a violation or exceedance of the State's water quality standards. Because the State water quality standards are based on EPA's Clean Water Act section 304(a) national recommended criteria developed to protect water quality and human health, discharges pursuant to those permits cannot include pollutants at a concentration that will harm either. As these surface water discharges flow downstream from the regulated point of discharge towards the Pine Ridge and Cheyenne River Reservations, they will be subject to dispersion, dilution and other forms of natural attenuation. As a result, concentrations of any pollutants from the project area that reach the reservation boundaries will be lower than concentrations at the regulated point of discharge and, therefore, will be lower than EPA's 304(a) national recommended criteria, which are developed to protect water quality and human health.

#### Impacts to groundwater or surface water inside of the project area

##### *Groundwater impacts*

Class III Injection - Class III wells within the project area will inject fluids into the mining zone in the Inyan Kara aquifers. EPA concluded in its Cumulative Effects Analysis that groundwater impacts in the project area due to underground injection pursuant to the Class III Area Permit will be minimal due to requirements that the permittee must restore the project area groundwater to pre-uranium ISR conditions. For example, Section 3.3.1 of EPA's Cumulative Effects Analysis states:

The NRC license requires Powertech to conduct groundwater restoration of the wellfield injection zone to restore the groundwater to meet 10 CFR Part 40, Appendix A, Criterion 5B(5) requirements. These requirements include restoration to meet Commission approved background concentrations, any applicable 10 CFR Part 40, Appendix A, Criterion 5C table

maximum values, whichever concentration is higher, or an Alternative Concentration Limit approved by NRC through a license amendment.

Further, Section 3.3.1 of EPA's Cumulative Effects Analysis concludes as follows: "Therefore, EPA concludes that ISR impacts to ore zone ground water quality after completion of groundwater restoration will be minimal compared to the pre-operational ore zone groundwater quality." As a result, even assuming for the sake of argument that tribes retain aboriginal or off-reservation treaty-based water rights to groundwater in the aquifer exemption area, any further degradation of water quality within the aquifer exemption area should be minimal.<sup>10</sup>

Additionally, the existing water quality is poor in the Inyan Kara aquifers in the aquifer exemption area, and without treatment is not safe for water uses cited by commenters. For example, groundwater quality data for Inyan Kara aquifers in the project area demonstrates that groundwater within the uranium ore zones in the aquifer exemption area exceeds drinking water standards (Maximum Contaminant Levels, or MCLs) for radionuclides. Further, that groundwater quality data demonstrates that groundwater within the uranium ore zones in the aquifer exemption area exceeds the South Dakota surface water criterion for radium-226, for uses such as irrigation and stock watering. Although this criterion does not apply to groundwater used above the surface, it indicates that it would nevertheless not be safe to use this groundwater for irrigation and stock water uses without further treatment.

Class V Injection – Class V well operations within the project area will inject fluids into the Minnelusa formation. While this will result in impacts to the Minnelusa formation at the project site, information reviewed by EPA indicates that the Minnelusa formation is not a USDW at the project site because it exceeds 10,000 mg/L of total dissolved solids (TDS). This means that the existing water quality at this site is so poor in the Minnelusa aquifer that it is not protected under the Safe Drinking Water Act. The Class V Area Permit requires the Permittee to sample the water quality of the Minnelusa to verify that it is a non-USDW prior to receiving an authorization to inject. If it confirmed to be a non-USDW, EPA has no authority to write permit conditions to protect it. If it is a USDW, the Permit prohibits injection into it.

Non-injection ISR operations - In addition to EPA's analysis of potential impacts from injection activities, the CEA also concludes that any impacts to groundwater from non-injection ISR operations, such as storage ponds or spills and leaks, will not result in any long-term effects and should not result in exposure to the public above health-based standards.

#### *Surface water impacts*

Class III and Class V Injection - Concerning impacts to surface water quality within the project area, EPA concluded in Section 4.7.1 of its Cumulative Effects Analysis that "EPA does not expect any impact to surface waters and wetlands from injection into the Minnelusa aquifer at the Dewey-Burdock Project Site," and in Section 4.8 of its Cumulative Effects Analysis that "EPA has concluded there will be no surface water impacts from Class III injection activities surface water and wetlands, and specifically to the Cheyenne River and other downstream communities along the Cheyenne River." As a result, even

---

<sup>10</sup> In EPA's July 8, 2019 letter to 38 federally-recognized tribes, which offered additional tribal consultation meetings, EPA asked tribes: "have treaty-based groundwater rights in the project area been recognized by judicial decree or Congressional settlement?" EPA has not received any comments demonstrating that off-reservation treaty-based surface water or groundwater rights claimed in the project area have been recognized by judicial decree or Congressional settlement.

assuming for the sake of argument that tribes retain aboriginal or off-reservation treaty-based water rights to surface water in the project area, EPA does not expect any impact to surface waters and wetlands within the project area from underground injection pursuant to the UIC permits.

Non-injection ISR operations - The primary source of potential surface water impacts from activities other than drilling and injection are those related to the general operation of the project. In particular, surface water impacts could result from impacts from land application of wastewater and discharges of stormwater during construction and operation of the facility. South Dakota's Large Scale Mine Permit regulates land application of wastewater, and stormwater discharges are regulated through the South Dakota's construction and industrial stormwater Clean Water Act National Pollution Discharge Elimination System (NPDES) general permits. The proposed Large Scale Mine Permit includes a requirement that process solutions, wastewater disposal, or surface water runoff from the site must not cause violations of the State's surface water quality standards. All NPDES permits issued under Section 402 of the Clean Water Act and its implementing state regulations, including stormwater general permits, must ensure that permitted discharges do not cause or contribute to an exceedance of water quality standards. Under Section 303(c) of the Clean Water Act, water quality standards must "protect the public health or welfare, enhance the quality of water and serve the purposes of [the Act]." Moreover, those standards reflect EPA's Clean Water Act section 304(a) national recommended water quality criteria, which themselves reflect the latest scientific knowledge of the identifiable effects on health and welfare of pollutants in water. Based on the proposed Large Scale Mine Permit and State NPDES stormwater general permits requirements, EPA concludes that concentrations of any pollutants from non-injection ISR operations in the project area will be at or below EPA's 304(a) national recommended criteria developed to protect water quality and human health.

#### Alternative sources of water

To the extent that activities authorized under the UIC permits may impact groundwater or surface water as detailed above, in violation of any aboriginal or off-reservation treaty-based water rights, tribes would be able to obtain more readily available water of better quality to satisfy any such water rights from alternative sources. For example, tribes could obtain water of better quality from surface water outside of the project area, as any discharges from the project will attenuate with distance. Tribes could also obtain groundwater of better quality from aquifers outside of the project area. Additionally, to exercise any aboriginal or off-reservation treaty-based water rights within the project area, the tribes would first need to obtain the right to access the project area, as the majority of the project area is located on private land. While the United States Bureau of Land Management (BLM) owns some land within the project area, there are no public roads that provide public access to those lands.

Finally, concerning other asserted violations of aboriginal rights or to treaty rights such as the Fort Laramie Treaties of 1851 and 1868, please refer to Response #212 above.

**216. The Cheyenne River Sioux Tribe holds reserved water rights in the Missouri River Basin as well as related groundwater in an amount necessary to fulfill the purposes of the Cheyenne River Sioux Reservation, and these rights are a function of the Tribe's extant treaty rights. The Dewey-Burdock Uranium Mine is proposed to be sited within the Tribe's 1851 territory and in areas that impact aquifers and tributaries that affect Cheyenne River**

**Sioux Reservation lands and waters. As such, the Dewey-Burdock Uranium Mine will have serious impacts on the Tribe's treaty rights and reserved water rights.**

Response #216:

Please refer to Response #215 above.

**217. The Cheyenne River Sioux Tribe retains reserved water rights in off-Reservation waterways and other bodies of water in the Missouri River Basin as well as groundwater and aquifers outside its Reservation. The Dewey-Burdock Uranium Mine is proposed to be sited within the Tribe's 1851 territory and in areas that impact aquifers and tributaries that affect Cheyenne River Sioux Reservation lands and waters. As such, the Dewey-Burdock Uranium Mine will have serious impacts on the Tribe's treaty rights and reserved water rights.**

Response #217:

Please refer to Response #215 above.

**218. The Oglala Sioux Tribe possesses reserved water rights to the Cheyenne River, under the legal principles established in *United States v. Winters*, 207 U.S. 564 (1908). The interconnection of the Madison and Minnelusa aquifers and of ground and surface water at artesian springs threatens the Cheyenne headwaters with contamination. The EPA lacks adequate data to demonstrate that our waters will remain protected.**

Response #218:

Please refer to Response #215 above. EPA addresses the interconnection of the Madison and Minnelusa aquifers and of ground water and surface water at artesian springs in Response #120 above.

**219. Under the principles enunciated by the United States Supreme Court in *Winters v. United States*, 207 U.S. 564 (1908), in the Fort Laramie Treaties, the Oglala Sioux Tribe reserved water rights for all present and future beneficial uses on the Pine Ridge Indian Reservation. The waters sources to fulfill our rights extend to all waters arising upon, flowing over, and bordering our Reservation, as well as to groundwater. Our reserved water rights extend to the Cheyenne River. The proposed injection wells threaten the Cheyenne River watershed near its headwaters. The proposed Dewey Burdock injection wells and potential migration pathways lead to the Cheyenne River. Dewey Burdock directly threatens waters subject to the Winters Doctrine water rights claims of the Oglala Sioux Tribe. Water rights are property rights, reserved in our Treaties. Our water rights extend to all waters needed for a permanent homeland. This includes the right to water free from contamination or degradation (*United States v. Gila Valley Irrigation Dist.*, 920 F.Supp. 1444 (D. Ariz. 1996)). Consequently, the risk to water quality posed by approval of Dewey-Burdock will violate the Winters Doctrine water rights of the Oglala Sioux Tribe.**

Response #218:

Please refer to Response #215 above.

**220. A number of commenters stated that the Dewey-Burdock uranium mine would result in contamination that would violate tribal hunting and fishing rights that were reserved pursuant to the Fort Laramie Treaties of 1851 and 1868.**

Response #220:

Because these comments are predicated upon a concern about contamination of waters supporting treaty-based hunting and fishing rights, please refer to Response #215 above.

**221. The Cheyenne River Sioux Tribe enjoys hunting and fishing rights in Lake Oahe, the reservoir of the Missouri River that are [*sic*] subject to the United States' trust duty. The rights are a function of the Tribe's extant treaty rights and have been preserved by Congress. Numerous off-Reservation tributaries and aquifers belong to the Lake Oahe hydrologic system and consequently will impact the Tribe's hunting and fishing rights in Lake Oahe. The Dewey-Burdock Uranium Mine is proposed to be sited within the Tribe's 1851 territory and in areas that impact aquifers and tributaries that affect Cheyenne River Sioux Reservation lands and waters. As such, the Dewey-Burdock Uranium Mine will have serious impacts on the Tribe's treaty rights and reserved water rights.**

Response #221:

Because these comments are predicated upon a concern about contamination of waters supporting treaty-based hunting and fishing rights, please refer to Response #215 above.

**222. There are numerous sites of historic, spiritual, and cultural significance to the Cheyenne River Sioux Tribe throughout the Tribe's large aboriginal territory, but especially within the boundaries of the lands reserved to the Tribe in the *Treaty of Fort Laramie with the Sioux, Etc.*, 11 Stat. 749 (Sep. 17, 1851 ). Furthermore, the Tribe's reserved water rights themselves constitute a spiritual and cultural resource in light of the primary role that water plays in Lakota religious sacraments, which require environmentally and ritually pure water. The Dewey-Burdock Uranium Mine is proposed to be sited within the Tribe's 1851 territory and in areas that impact aquifers and tributaries that affect Cheyenne River Sioux Reservation lands and waters. As such, the Dewey-Burdock Uranium Mine will have serious impacts on the Tribe's treaty rights and reserved water rights and the Tribe's cultural resources.**

Response #222:

Because these comments are predicated upon a concern about contamination of waters supporting tribal religious sacraments, and spiritual and cultural resources, please refer to Response #215 above.

**223. The current analyses of the Dewey-Burdock Uranium Mine specifically identifies the Cheyenne River and its tributaries as an area that will be affected by the Dewey-Burdock Uranium Mine. Significantly, however, the current analyses conspicuously do not address the impacts of the mining activity on the Cheyenne River Sioux Tribe. There is no risk data concerning human health impact of the Dewey-Burdock Uranium Mine on the Cheyenne River Sioux people as it relates to the aquifers, watersheds, or tributaries that feed our Reservation. There is no analysis of impacts to fish and wildlife on our Reservation and in Lake Oahe, to which we have rights embodied in both Treaty and federal statute. There is also no analysis of impacts upon plants that we rely upon for food and medicine.**

Response #223:

Because the comments concern contamination of water, and because the comments regarding public health, plants, and treaty-based fish and wildlife rights are predicated upon a concern about contamination of water, please refer to Response #215 above.

**224. A number of commenters stated that the trust relationship [federal trust responsibility] requires the federal government to protect the property and resources of Indian tribes, including rights to water and protection of sacred sites.**

Response #224:

This comment raises questions about the nature and extent of the federal trust responsibility to federally-recognized tribes. EPA understands the importance of these comments and considered the federal trust responsibility in this matter. Federal agencies can be subject to general or specific tribal trust responsibilities. Pursuant to relevant court decisions, the federal general trust responsibility does not create an independent, enforceable mandate or specific trust requirement beyond EPA's obligation to comply with the legal requirements generally applicable to this situation under federal law. See, e.g., *Morongo Band of Mission Indians v. FAA*, 161 F.3d 569, 574 (9th Cir. 1998); *Gros Ventre Tribe v. United States*, 469 F.3d 801, 809-814 (9th Cir. 2006). In this case, EPA's issuance of the final UIC permits pursuant to the Safe Drinking Water Act is consistent with the federal general trust responsibility, as the final UIC permits contain adequate conditions to protect underground sources of drinking water as required by that Act.

Specific trust responsibilities derive from statutes. *United States v. Jicarilla Apache Nation*, 564 U.S. 162, 177 (2011) ("The Government assumes Indian trust responsibilities only to the extent it expressly accepts those responsibilities by statute"). One commenter stated that Article VIII of the Congressional Act of February 28, 1877 (19 Stat. 254 (1877)) creates a federal trust obligation ("Congress shall, by appropriate legislation, secure to them an orderly government; they shall be subject to the laws of the United States, and each individual shall be protected in his rights of property, person, and life."). Another commenter stated that the Fort Laramie Treaties of 1851 and 1868 create specific trust responsibilities to protect the rights reserved in those treaties. Federal courts have also considered whether treaties can create specific trust responsibilities. See, e.g., *Flute v. United States*, 808 F.3d 1234 (10th Cir. 2015); *Blue Legs v. U.S. Bureau of Indian Affairs*, 867 F.2d 1094, 1100 (8th Cir. 1989) ("The

existence of a trust duty between the United States and an Indian or Indian tribe can be inferred from the provisions of a statute, treaty or other agreement, 'reinforced by the undisputed existence of a general trust relationship between the United States and the Indian people.'") (internal citations omitted). Assuming for the sake of argument that Article VIII and various treaties with tribes have created specific trust responsibilities to protect tribal rights to water and sacred sites, EPA considered potential impacts from the final UIC permits. See Response #215. Concerning sacred sites, EPA recognizes that many tribes and tribal members hold spiritual and cultural interests in the Black Hills, and EPA thus revised the EJ Analysis to include consideration of those interests in the Black Hills as a sacred site to many Native American tribes.

Finally, concerning asserted violations of aboriginal rights of land ownership or to treaty rights to land ownership, such as the Fort Laramie Treaties of 1851 and 1868, please refer to Response #212 above.

**225. The United States has a two-fold trust duty to the Cheyenne River Sioux Tribe. Courts have long recognized the "existence of a general trust relationship between the United States and the Indian people." *United States v. Mitchell*, 463 U.S. 206, 225 (1983). The courts are clear that "any Federal government action is subject to the United States' fiduciary responsibilities toward the Indian tribes." *Nance v. EPA*, 645 F.2d 701, 711 (9th Cir. 1981) (emphasis in original) (citing *Seminole Nation v. United States*, 316 U.S. 268, 297 (1942)). Secondly, the federal government has a specific trust duty to protect the rights reserved in the 1851 and 1868 Fort Laramie Treaties. The Tribe was a party to the 1851 and 1868 Fort Laramie Treaties, which reserved land and water to the Tribe in order to fulfill the purpose of the Reservation to provide for self-sufficiency. See *Winters v. United States*, 207 U.S. 564 (1908). The reserved water right recognized in the *Winters* doctrine, and reserved for the Tribe, includes the right to clean, safe water. See, e.g., *United States v. Gila River Irrigation Dist.*, 920 F. Supp. 1444, 1448 (D. Ariz. 1996). Likewise, the Tribe has retained its right to hunt, fish, and gather on the Reservation and in Lake Oahe. Act of September 3, 1954, Pub. L. 83-766, 68 Stat. 1191; *South Dakota v. Bourland*, 508 U.S. 679, 697 (1993) (noting that Congress explicitly has reserved the Cheyenne River Sioux Tribe's original treaty rights, including the right to hunt and fish, on Lake Oahe); see also *United States v. Dion*, 476 U.S. 734, 738 (1986) ("Indians enjoy exclusive treaty rights to hunt and fish on lands reserved to them .... "). The Tribe's water rights include a right to water that is sufficient in amount and quality to support hunting and fishing rights. *United States v. Adair*, 723 F.2d 1394, 1409, 1411 (9th Cir. 1983). As a result of the federal government's trust responsibilities to the Tribe, the EPA must ensure that such trust resources are preserved in any activity that may impact the Tribe's rights, including the Underground Injection Control Draft Area Permit and Proposed Aquifer Exemption decision for Dewey-Burdock Uranium In-Situ Recovery Site.**

Response #225:

Because these comments concern contamination of water, and because the comments regarding hunting, fishing and gathering rights are predicated upon a concern about contamination of water, please refer to Response #215 above.

In addition, because these comments raise questions about the federal trust responsibility to federally-recognized tribes, please refer to Response #224 above.

**226. As a federal agency of the United States government, EPA has a fiduciary duty to protect the Oglala Sioux Tribe and its members from any adverse impacts resulting from uranium mining the Dewey-Burdock project area of the southern Black Hills, including adverse impacts from ground water contamination that affects the spiritual significance of sacred sites and burial sites (both known and yet to be discovered), and the destruction of the Tribe's Winters Doctrine Water Rights and aboriginal water rights in the Cheyenne River and its tributary streams and creeks. Winters Doctrine water rights are vested, Fifth Amendment property rights held in trust by Federal Government. The Oglala Sioux Tribe's off-reservation and on-reservation Winters Doctrine and aboriginal ground and surface water rights in the Cheyenne River and its tributaries are trust property. This includes the ground waters in the Dewey-Burdock Project Area that feed the Cheyenne River.**

Response #226:

Because these comments concern contamination of water, please refer to Response #215 above. Response #239 below discusses Class III Area Permit requirements designed to ensure injected fluids are confined vertically and horizontally to the approved injection interval and will not impact USDWs or surface water, including the Cheyenne River. Further, in Response #239 below, EPA discussed evaluation of groundwater flow in the Minnelusa injection zone from the Dewey-Burdock site to the Pine Ridge Indian Reservation. EPA concludes that Class V injectate from the Dewey-Burdock Project Site will not have an impact on water quality in groundwater aquifers underlying the Pine Ridge Indian Reservation. Response #120 above discusses EPA's analysis of the Class V injectate flow path downgradient from the Dewey-Burdock Project Site. Based on this analysis, EPA concludes that the Class V injectate will not reach the location of the artesian springs in the southern Black Hills where the Minnelusa and Madison aquifer groundwater flows to the surface and eventually reaches the Cheyenne River.

Regarding the federal trust responsibility to federally-recognized tribes, please refer to Response #224 above. Regarding treaty rights and aboriginal rights, please refer to Response #212 above.

**227. A number of commenters stated that Executive Order 13175 on consultation and coordination with Indian Tribal Governments requires all agencies to respect Treaty rights ("The United States continues to work with Indian tribes on a government-to-government basis to address issues concerning Indian...treaty and other rights. Agencies shall...honor treaty rights and other rights."), and approval of the Dewey-Burdock permit violate [*sic*] the 1868 Fort Laramie Treaty.**

Response #227:

As explained in Response #200 above, EPA conducted extensive tribal consultation pursuant to EPA Tribal Consultation Policy, and EPA Treaty Rights Guidance, including inquiring with tribes about the



potential for underground injection within the project area to impact tribal treaty rights if EPA approved the UIC permit applications. The EPA Tribal Consultation Policy states that the policy:

“[C]omplies with the Presidential Memorandum (Memorandum) issued November 5, 2009, directing agencies to develop a plan to implement fully Executive Order 13175 (Executive Order). The Executive Order specifies that each Agency must have an accountable process to ensure meaningful and timely input by tribal officials in the development of regulatory policies that have tribal implications.”

Additionally, concerning alleged violations of treaty rights pursuant to the Fort Laramie Treaty of 1868, please refer to Responses #212 and #215 above.

**228. A number of commenters stated that EPA is legally required to comply with the United Nations Declaration of Rights of Indigenous Peoples, including the following provisions:**

- **States shall take effective measures to ensure that no storage or disposal of hazardous materials shall take place in the lands or territories of indigenous peoples without their free, prior and informed consent.**
- **Indigenous peoples shall have the right to the recognition, observance and enforcement of treaties.**
- **Indigenous people have the right to maintain and strengthen their distinctive spiritual relationship with their traditionally owned or otherwise occupied lands.**

Response #228:

EPA recognizes the importance of the United Nations Declaration on the Rights of Indigenous Peoples (UNDRIP) and believes that EPA tribal policies support many of the principles under UNDRIP. EPA Tribal Consultation Policy and EPA Treaty Rights Guidance support consultation on a government-to-government basis when EPA proposed actions or decisions may affect a tribe's interest. EPA Tribal Consultation Policy and EPA Treaty Rights Guidance are consistent with Executive Order 13175 (Consultation and Coordination With Indian Tribal Governments) and reflects the principles expressed in EPA Policy for the Administration of Environmental Programs on Indian Reservations, often referred to as the 1984 EPA Indian Policy. However, EPA is not legally required to comply with UNDRIP.

**229. The Federal Government has a fiduciary duty to protect the Sioux tribes' under the legal principles recognized in *Charrier v. Bell*, 496 So. 2d 601 (La. App. 1 Cir. 1986) cert. denied, 498 So. 2d 753 (La. 1986) (Tunica-Biloxi Tribe retained ownership of cultural items discovered on privately held lands) and *Black Hills Inst. of Geological Research v. South Dakota Sch. of Mines*, 12 F.3d 737, 742-744 (8th Cir. 1993) (Black Hills III) (Because the [dinosaur] fossil was trust property that was removed from the Indian trust land without the knowledge or consent of the United States, it remained the property of the United States). Likewise, the tribe's cultural resources located on private lands are still trust property held in trust for the tribes by the United States, were not conveyed to the present non-Indian occupants under the Homestead Act or otherwise; the United States**

**and its agencies therefore have a fiduciary duty to protect these cultural resources on private lands to the same extent that it had a duty to a dinosaur fossil removed from trust land in the Black Hills Inst., supra.**

Response #229:

Regarding tribal ownership of the project area and the Black Hills generally, including ownership of tribal cultural resources by tribes or by the United States on behalf of tribes, please refer to Response #212 above. Regarding the federal trust responsibility to federally-recognized tribes, please refer to Response #224 above.

### **General Tribal Concerns**

**230. The federal government has a legally-recognized federal trust responsibility to protect Native American sacred sites. Executive Order No. 13007, the Native American Graves Protection and Repatriation Act, the Religious Freedom Restoration Act, and the American Indian Religious Freedom Act all offer protections for Native American sacred sites and weigh in favor of denying the permits.**

Response #230:

Regarding the federal trust responsibility to federally-recognized tribes, please refer to Response #224 above.

Executive Order 13007 (61 Fed. Reg. 26771, May 24, 1996), concerning Indian sacred sites, applies to each “executive branch agency with statutory or administrative responsibility for the management of Federal lands.” Because EPA is a regulatory agency and is not responsible for the management of Federal lands, EO 13007 does not apply directly to EPA in this case. Nevertheless, as a result of Tribal consultation discussions and comments received on the 2017 Draft EJ analysis, the 2019 Revised Draft EJ Analysis expanded the scope of the analysis to include consideration of tribal spiritual and cultural interests in the Black Hills as a sacred site to many Tribal Nations and tribal members. While recognizing tribal interests in these sacred sites, EPA’s authorities under the Safe Drinking Water Act to address potential impacts from underground injection under the final UIC permits are limited to the protection of underground sources of drinking water (USDWs). On that basis, the final UIC permits include permit conditions to protect USDWs, thus protecting against endangerment of USDWs with respect to all potentially-affected communities, including tribal communities. Moreover, EPA will “avoid adversely affecting the physical integrity of such sacred sites” because the final UIC permits do not convey property rights, nor do they authorize injury to persons or property. E.O. 13007(1)(a)(2). Also, Executive Order 13007 does not create a private right of action and is not legally enforceable against EPA.

EPA’s issuance of the final UIC permits does not implicate the Native American Graves Protection and Repatriation Act (NAGPRA), 25 U.S.C. § 3001 et seq. Among other reasons, EPA’s issuance of the final UIC permits is a regulatory action and is not the type of excavation work that could inadvertently

unearth cultural items subject to NAGPRA that could trigger compliance with the Act. Nevertheless, as described in response to comment 200, on multiple occasions EPA offered to consult with tribal governments under section 106 of the National Historic Preservation Act concerning potential historic properties, including those of traditional religious and cultural importance. While recognizing tribal interests in cultural items subject to NAGPRA, however, EPA's authorities under the Safe Drinking Water Act to address potential impacts from underground injection under the final UIC permits are limited to the protection of underground sources of drinking water.

EPA's issuance of the final UIC permits does not implicate the Religious Freedom Restoration Act, 42 U.S.C. § 2000bb et seq. Among other reasons, EPA's issuance of the final UIC permits does not "substantially burden" any person's exercise of religion, for example by prohibiting any religious practices. Comments concerning the potential for underground injection within the project area to impact tribal religion are predicated upon a concern about contamination of waters supporting tribal religious sacraments, which are addressed in Response #215 above.

EPA's issuance of the final UIC permits does not implicate the American Indian Religious Freedom Act ("AIRFA"), 42 U.S.C. § 1996. Among other reasons, EPA's issuance of the final UIC permits will not prohibit access to sacred sites located on federally held lands within the Dewey-Burdock Project Area. Also, AIRFA does not create a private right of action and is not legally enforceable against EPA.

**231. Under RFRA, the "Government shall not substantially burden a person's exercise of religion" unless the Government "demonstrates that application of the burden to the person-(1) is in furtherance of a compelling governmental interest; and (2) is the least restrictive means of furthering that compelling governmental interest." 42 U.S.C. § 2000bb-1(b). Tribal religious practices are significantly tied to oral tradition, ancestral lands, and natural resources.**

Response #231:

EPA's issuance of the final UIC permits does not implicate the Religious Freedom Restoration Act, 42 U.S.C. § 2000bb et seq. Among other reasons, EPA's issuance of the final UIC permits does not "substantially burden" any person's exercise of religion, for example by prohibiting any religious practices. Comments concerning the potential for underground injection within the project area to impact tribal religion are predicated upon a concern about contamination of waters supporting tribal religious sacraments, which are addressed in Responses #215 and #222 above.

**232. The Dewey Burdock Uranium Mine Poses a Serious Threat to the Cheyenne River Sioux Tribe's Religious Exercise. Water is an essential aspect of the Lakota religion. It figures prominently in our theology as the origin of our creation as Lakota people and as a key aspect of how we became who we are today. In addition, water is a key component of many of our religious ceremonies. While many of our religious sacraments require either water or ritual deprivation thereof, water is an essential component of one of our most important religious sacraments, the *inipi* ceremony or sweat lodge. Importantly, this sacrament requires that we use only water that is both environmentally and ritually pure.**

**As noted above, the Tribe has very limited access to water on the Reservation and relies solely on water drawn from the confluence of the Cheyenne River and the Missouri River at Lake Oahe for its drinking water and which represents reserved water rights of the Tribe. Upstream contamination of these waters in which the Tribe owns reserved water rights has the very serious potential to affect the Tribe's and its members' religious exercise in violation of the Religious Freedom Restoration Act.**

Response #232:

EPA's issuance of the final UIC permits does not implicate the Religious Freedom Restoration Act, 42 U.S.C. § 2000bb et seq. Among other reasons, EPA's issuance of the final UIC permits does not "substantially burden" any person's exercise of religion, for example by prohibiting any religious practices. Comments concerning the potential for underground injection within the project area to impact tribal religion are predicated upon a concern about contamination of waters supporting tribal religious sacraments, which are addressed in Responses #215 and #222 above. For more information on concerns about potential impacts to the Cheyenne River, please see Responses # 239 and #304 below. For information on the potential impacts to present day water uses, including for ceremonial practices, please see Response #243 below.

**233. The Oglala Sioux Tribe ordinance 07-40 prohibits nuclear pollution or contamination from entering the Pine Ridge Indian Reservation.**

Response #233:

EPA respects the authority of the Oglala Sioux Tribe's government to establish tribal law applicable to its jurisdiction. Because this comment concerns the potential for underground injection or other ISR operations within the project area to contaminate surface water on or groundwater beneath a reservation, please refer to Response #215 above. Response #239 below discusses EPA's analyses leading to the conclusions that injection activity will not result in impacts to surface water or groundwater at the Pine Ridge Indian Reservation. Response #215 discusses potential impacts to surface water from other ISR operations at the Dewey-Burdock Site, such as land application of waste fluids and stormwater discharges during construction and operations. EPA analyses discussed in Response #215 lead to the conclusion that there will be no water quality impacts to surface water or groundwater at the Pine Ridge Indian Reservation from other ISR operations at the Dewey-Burdock Site.

**234. In opposition to the proposed Dewey-Burdock uranium mine, relevant US legislation/Executive Orders to this matter include: Antiquities Act (1906); National Park Service Organic Act (1916); Historic Sites Act (1935); Wilderness Act (1964); National Historic Preservation Act (1966); National Environmental Policy Act (1970); Protection and Enhancement of the Cultural Environment: Executive Order 11593 (1971); Endangered Species Act (1973); Archaeological Resources Protection Act (1979); Abandoned Shipwreck Act (1987); National Register Bulletin 38: Guidelines for Evaluating and Documenting Traditional Cultural Properties (1990); Native American Graves and Repatriation Act (1990); Indian Sacred Sites: Executive Order 13007 (1996)**

**Relevant treaties/case law to this matter include: Johnson v. McIntosh (1823); Treaty of July 5, 1825 with the Sioune and Oglala Tribes (1825); Fort Laramie Treaty (1851); Fort Laramie Treaty (1868); Antarctica Treaty (1959) (Demonstrating colonial/imperial theft.); United States v. Sioux Nation of Indians (1980) (Docket 74, proving the theft/illegal taking of the Black Hills in violation of the 1868 Fort Laramie Treaty); City of Albuquerque v. Browner (1993) (Isleta Pueblo win against the City of Albuquerque, affirming that Isleta residents have the right to clean river water for the purposes of farming and religious ceremony.); Washington State Department of Licensing v. Cougar Den, Inc. (2019) (Affirming that the 1855 treaty between the United States and the Yakama Nation forbids the State of Washington to impose a fuel tax on Yakama Nation members.); Herrera v. Wyoming (2019) (Affirming that the Crow Tribe's hunting rights, as established in the 1868 treaty between the United States and the Crow Tribe, in exchange for lands comprising most of what is currently Montana and Wyoming, did not expire upon the establishment of the State of Wyoming.)**

Response #234:

The commenter does not explain how the listed laws, executive orders, treaties, guidance document, and case law are relevant to the UIC permits.

EPA views the following laws, executive orders, guidance document and treaties cited by the commenter as inapplicable to EPA's issuance of the final UIC permits in this matter (note, however, that the UIC permits do not relieve the permittee from its legal obligations to comply with any applicable federal, state or local laws or regulations):

- The Antiquities Act of 1906, 54 U.S.C. §§ 320301-320303; 18 U.S.C. § 1866(b) (for example, the final UIC permits do not authorize the appropriation, excavation, injury, or destruction of any historic or prehistoric ruin or monument, or any object of antiquity, situated on lands owned or controlled by the Government of the United States, nor shield the permittee from its legal obligations under the Act on such lands within the project area; nor does the project area include any national monument lands);
- National Park Service Organic Act, 54 U.S.C. §§ 54 USC 100101, 100301-100302; et al.) (for example, the project area does not include any National Park System lands);
- Historic Sites Act, 54 U.S.C. §§ 102303, 102304, 309101, 320101-320106 (for example, this Act does not apply to EPA's issuance of the final UIC permits in this matter, although EPA has separately complied with the National Historic Preservation Act as explained in Response #263 below);
- Wilderness Act, 11 U.S.C. §§ 1131-1136 (for example, the project area is not located in a designated wilderness area);
- National Environmental Policy Act (NEPA), 42 U.S.C. §§ 4321-4370h. See Response # 264 below regarding NEPA applicability.
- Executive Order 11593: Protection and Enhancement of the Cultural Environment (36 FR 8921, May 13, 1971) (for example, this Executive Order does not apply to EPA's issuance of the final UIC permits in this matter of, although EPA has separately complied with the National Historic Preservation Act as explained in Response #263 below);
- Archaeological Resources Protection Act, 16 U.S.C. §§ 470aa-mm (for example, EPA is not a federal land manager conferred with permitting or other authority under the Act, and EPA's

issuance of the final UIC permits in this matter does not shield the permittee from its legal obligations to comply with the Act on federal public lands within the project area; additionally, EPA has separately complied with the National Historic Preservation Act as explained in Response #263 below);

- Abandoned Shipwrecks Act, 43 U.S.C. §§ 2101-2106 (for example, EPA is unaware of any abandoned shipwrecks in the project area);
- Native American Graves Protection and Repatriation Act, 25 U.S.C. § 3001 et seq. (see Response #230 above);
- Executive Order 13007: Indian Sacred Sites (61 Fed. Reg. 26771, May 24, 1996) (see Response #230 above);
- National Park Service, National Register Bulletin 38: Guidelines for Evaluating and Documenting Traditional Cultural Properties (for example, the Bulletin is a source of guidance for federal agencies that may be consulted for assistance in evaluating traditional cultural properties, and inherently cannot impose any requirements on EPA's action. EPA has separately complied with the National Historic Preservation Act as explained in Response #263 below.);
- Antarctic Treaty, Dec. 1, 1959, 12 U.S.T. 794, T.I.A.S. No. 4780, 1961 WL 62657 (for example, the project area is not located in Antarctica).

EPA views the following as applicable to its issuance of the final UIC permits in this matter:

- National Historic Preservation Act, 54 USC § 300101: See Response #263 below.
- Endangered Species Act [16 U.S.C. § 1531 et seq. (1973)]: Consistent with 40 CFR part 144.4(c), and the Endangered Species Act, Section 7(a)(2), EPA determined that its decision to issue the UIC permits at issue are actions subject to the ESA and its implementing regulations (50 CFR part 402).
- Regarding the Treaty of July 5, 1825 with the Sioux and Oglala Tribes (7 Stat. 252); the Fort Laramie Treaty of 1851 (11 Stat. 749); the Fort Laramie Treaty of 1868 (15 Stat. 635); and *United States v. Sioux Nation of Indians*, 448 U.S. 371 (1980), please refer to Responses #212 and #215 above.

EPA recognizes the following federal court decisions as stating important federal Indian law principles, but concludes that they do not require EPA to deny the UIC permit applications:

- *Johnson v. M'Intosh*, 21 U.S. 543 (1823) (right of the British government to lands occupied by tribal nations passed to the United States, and tribal nations did not have the right to sell property to individuals). EPA's issuance of the final UIC permits does not involve the purported sale of property by tribal governments to individuals. Regarding land ownership of the Black Hills and the project area, please refer to Response #212 above.
- *City of Albuquerque v. Browner*, 865 F. Supp. 733 (D.N.M. 1993), *aff'd*, 97 F.3d 415 (10th Cir. 1996) (rejecting challenge to EPA's approval of Isleta Pueblo's Clean Water Act water quality standards). EPA's issuance of the final UIC permits does not relate to the approval of tribal water quality standards. Regarding tribal ceremonial uses of water, please refer to Responses #215 and #222 above.
- *Washington State Dep't of Licensing v. Cougar Den, Inc.*, 139 S. Ct. 1000, 203 L. Ed. 2d 301 (2019) (1855 treaty between United States and Yakama Nation forbids State of Washington from imposing tax upon fuel importers who travel by public highway to importers who are members

of Yakama Nation). The unique provision of the 1855 treaty between the United States and the Yakama Nation is not part of any treaty raised by commenters relating to EPA's issuance of the final UIC permits, and in any event would not appear to apply in South Dakota. Regarding asserted tribal treaty rights generally, please refer to Responses #212 and #215 above.

- *Herrera v. Wyoming*, 139 S. Ct. 1686, 203 L. Ed. 2d 846 (2019) (Rejecting arguments that Crow Tribe's off-reservation hunting rights under 1868 treaty were lost due to Wyoming's statehood or by lands becoming "occupied" within Bighorn National Forest when set aside as a national reserve). No comments asserted that the Crow Tribe's off-reservation hunting rights exist in the project area, but even assuming that they do, please refer to Response #215. Regarding asserted tribal treaty rights generally, please refer to Responses #212 and #215 above.

**235. You've issued a 151-page draft Cumulative Effects Analysis [the EPA 2017 draft Cumulative Effects Analysis]. I was hoping to see more than seven sentences on tribal concerns. Seven sentences is what was given to the Great Sioux Nation. Dakota Access, Keystone XL, Crow Butte, and Powertech, where is the cumulative effects analysis for all of the permits and aquifer exemptions that have the potential to impact the tribes of the Great Sioux Nation? I don't see your Agency fulfilling any type of trust responsibilities in this regard, and it falls on us to fight. It seems that all we do is fight for our water, for environment, for our survival.**

Response #235:

Please refer to Response #332 below regarding this comment.

### Environmental Justice

#### Comments on the Geographic Scope of the Environmental Justice Analysis

Commenters suggest that EPA revise and expand the geographic scope of the Environmental Justice (EJ) Analysis in various ways. While EPA responses to each of these specific geographic scope comments are set forth below, the following is an explanation of EPA's rationale for maintaining a 20-mile geographic scope for the EJ Analysis of demographics and environmental indicators utilizing the EJSCREEN tool, as well as the Agency's decision to expand the scope of the analysis for purposes of considering Tribal spiritual and cultural interests in the Black Hills.

The EJ Analysis identifies a Study Area comprised of a 20-mile buffer zone measured from the approximate project area boundary. The 20-mile radius is consistent with the separate cumulative effects analysis (CEA) that assesses potential groundwater, surface water, air and other relevant impacts associated with EPA's actions. EPA considered the farthest potential environmental impacts, which are the air impacts, from the Agency's Safe Drinking Water Act (SDWA) actions to determine the appropriate geographic scope for both the EJ and cumulative effects analyses. EPA considered the 20-mile screening area to be an appropriate Study Area for this EJ Analysis based on air modeling showing detectable air impacts above background levels potentially reaching 20 miles from the project area, as

described in the document entitled, *Ambient Air Quality Final Modeling Protocol and Impact Analysis Dewey-Burdock Project Powertech (USA), Inc., Edgemont, South Dakota*. (IML, 2013)

Generally, utilizing the EJSCREEN tool, EPA screens communities within the geographic scope of an EJ Analysis and compares the demographic and environmental indicators for those communities to an appropriate community of reference, such as the rest of the state, EPA region, or the nation. Consistent with this practice, EPA conducted an EJSCREEN analysis for a 20-mile radius around the project area based upon the various demographic and environmental indicators discussed in the EJ Analysis. Within the Study Area, EPA also conducted a separate EJSCREEN analysis on an area comprising a 5-mile radius around Edgemont, South Dakota, an area identified as a potentially overburdened community.

Based on Tribal consultation discussions and comments received on the 2017 Draft EJ Analysis, in 2019, EPA issued a Revised Draft EJ Analysis for the Proposed UIC Permitting Actions for the Dewey-Burdock Uranium In-Situ Recovery Project in the Southern Black Hills Region of South Dakota (2019 Revised Draft EJ Analysis). In addition to the analysis of the 20-mile Study Area, the 2019 Revised Draft EJ Analysis expanded the scope of the EJ analysis in two ways: 1) to include consideration of tribal spiritual and cultural interests in the Black Hills which, in its entirety, extends beyond 20 miles from the Project Area; and 2) although the formal Indian Reservations of potentially affected Indian tribes are located well beyond the 20-mile radius, the revised analysis considers tribal spiritual and cultural interests in the Black Hills regardless of where the tribal members may permanently reside. EPA recognizes that many tribes and tribal members hold spiritual and cultural interests in the Black Hills, and EPA thus revised the EJ Analysis to include consideration of those interests in the Black Hills as a sacred site to many Native American tribes. However, the EJ Analysis maintains the 20-mile radius for the EJSCREEN analysis of demographic, socioeconomic and environmental indicators, because the analysis is based upon the farthest potential environmental impacts from EPA's action.

**236. Geographic Scope – Watershed Analysis Approach: the commenter suggests that the EJ Analysis be expanded by implementing a watershed approach rather than utilizing a 20-mile radius around the project area.**

Response #236:

The Dewey-Burdock project site is located in the Cheyenne River basin. Response #239 below discusses SDWA Underground Injection Control (UIC) Class III Area Permit requirements designed to prevent impacts to the Cheyenne River from In-Situ Recovery (ISR) injection activities. Response #239 also includes EPA's analysis of Minnelusa groundwater flow from the Dewey-Burdock site that supports the Agency's conclusion that there will be no surface water impacts from UIC Class V injection activity at the Dewey-Burdock project site. The point source discharges from the project to surface waters will be from construction and industrial stormwater flows and must comply with South Dakota DENR's construction and industrial stormwater NPDES permits. Under Section 402 of the Clean Water Act and its implementing regulations, those permits must ensure that permitted discharges do not cause or contribute to exceedances of South Dakota's surface water quality standards. Under Section 303(c) of the Clean Water Act, water quality standards must "protect the public health or welfare, enhance the quality of water and serve the purposes of [the Act]." Moreover, those standards reflect EPA's Section 304(a) national recommended water quality criteria, which themselves reflect the latest scientific



knowledge of the identifiable effects on health and welfare of pollutants in water. As the surface water discharges flow downstream from the regulated point of discharge, they will be subject to dispersion, dilution and other forms of natural attenuation. The distance from CHR05, the downgradient operational monitoring location on the Cheyenne River to the 20-mile radius boundary of the EJ Study Area is 33 river miles as measured along the flow path of the Cheyenne River. If any concentrations of pollutants from the Project Area reach the 20-mile boundary, they will be in lower concentrations than at the regulated point of discharge and lower than EPA's 304(a) national recommended criteria, which are developed to protect water quality and human health.

Thus, EPA concludes there will be no impacts to the Cheyenne River or the Cheyenne River watershed from the Dewey-Burdock injection activities. Other non-injection related impacts from the Project Area on the Cheyenne River water quality will be below EPA's 304(a) national recommended criteria developed to protect water quality and human health and further decreased by 33 river miles of dispersion, dilution and other forms of natural attenuation. Therefore, EPA concluded that basing the EJ Study Area on a 20-mile buffer zone, captures impacts from the Dewey-Burdock Project on the Cheyenne River as effectively as using the Cheyenne River watershed area.

**237. Geographic Scope – Town of Buffalo Gap: the commenter states that the town of Buffalo Gap, SD has a history of high uranium levels in the water and should be included in the EJ Analysis; that enhanced public participation and outreach requirements should be made available to the residents of Buffalo Gap; and that the 20-mile radius for the EJ Analysis fails to consider the flows of water or related aquifers that impact areas farther away such as Buffalo Gap, SD.**

Response #237:

EPA has investigated the injection zone aquifer flow directions from the Dewey-Burdock Project Area relative to the Town of Buffalo Gap, South Dakota. Figure L is the southern portion of Sheet 2 from Strobel et al., 2000, which shows that the Dewey-Burdock Project Site and Buffalo Gap are located on opposite sides of the Black Hills. (Strobel et al., 2000). The Inyan Kara aquifer groundwater flow at the two locations is in opposite directions, as indicated by the potentiometric surface contours that approximately follow the dip of geologic strata away from the Black Hills uplift.

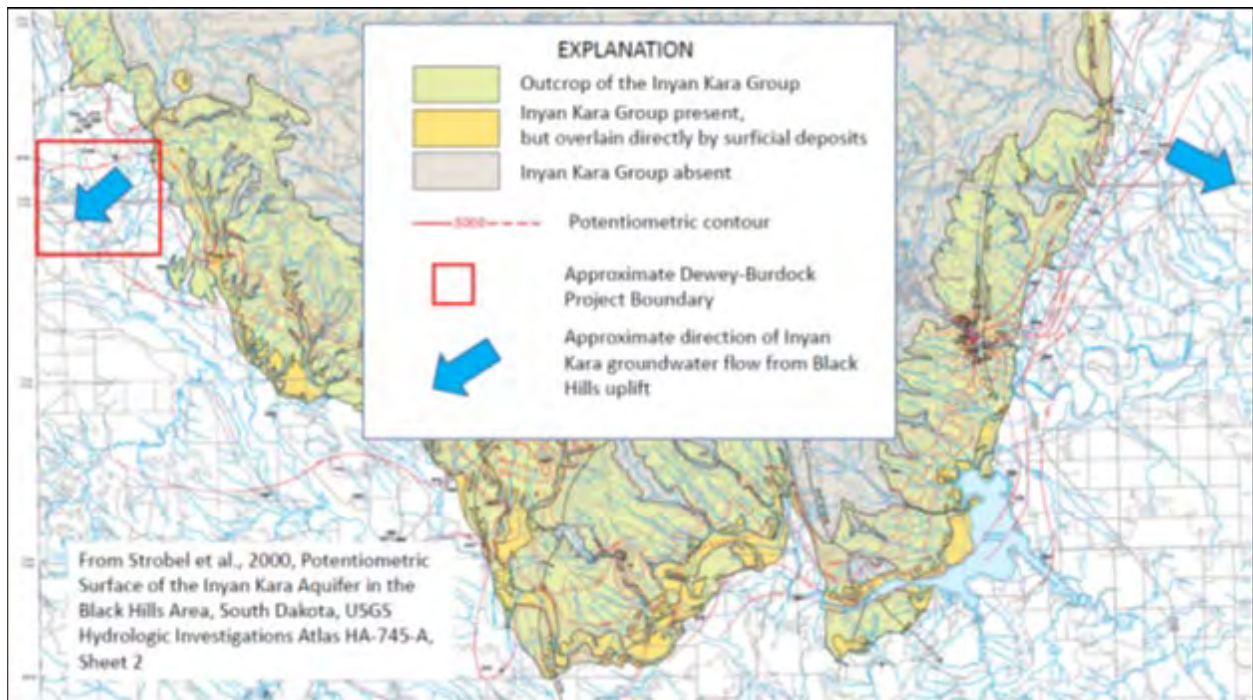

**Figure L. The relative locations of the Dewey-Burdock Project Site and Town of Buffalo Gap locations in the Black Hills and Inyan Kara groundwater flow direction.**

Figure M below shows the groundwater flow directions of the Minnelusa injection zone aquifer at the Dewey-Burdock Project Site and at the Town of Buffalo Gap from Carter et al., 2001, *Hydrologic budgets for the Madison and Minnelusa aquifers, Black Hills of South Dakota and Wyoming, water years 1987-96*: USGS Water-Resources Investigations Report 01-4119. Buffalo Gap is located near the southern border in subarea 7 and the Dewey-Burdock site is located near the pink arrow crossing the boundary between subareas 8 and 9. Based on this Minnelusa aquifer flow direction map, Class V injectate into the Minnelusa aquifer at the Dewey-Burdock project site will not reach the Town of Buffalo Gap.

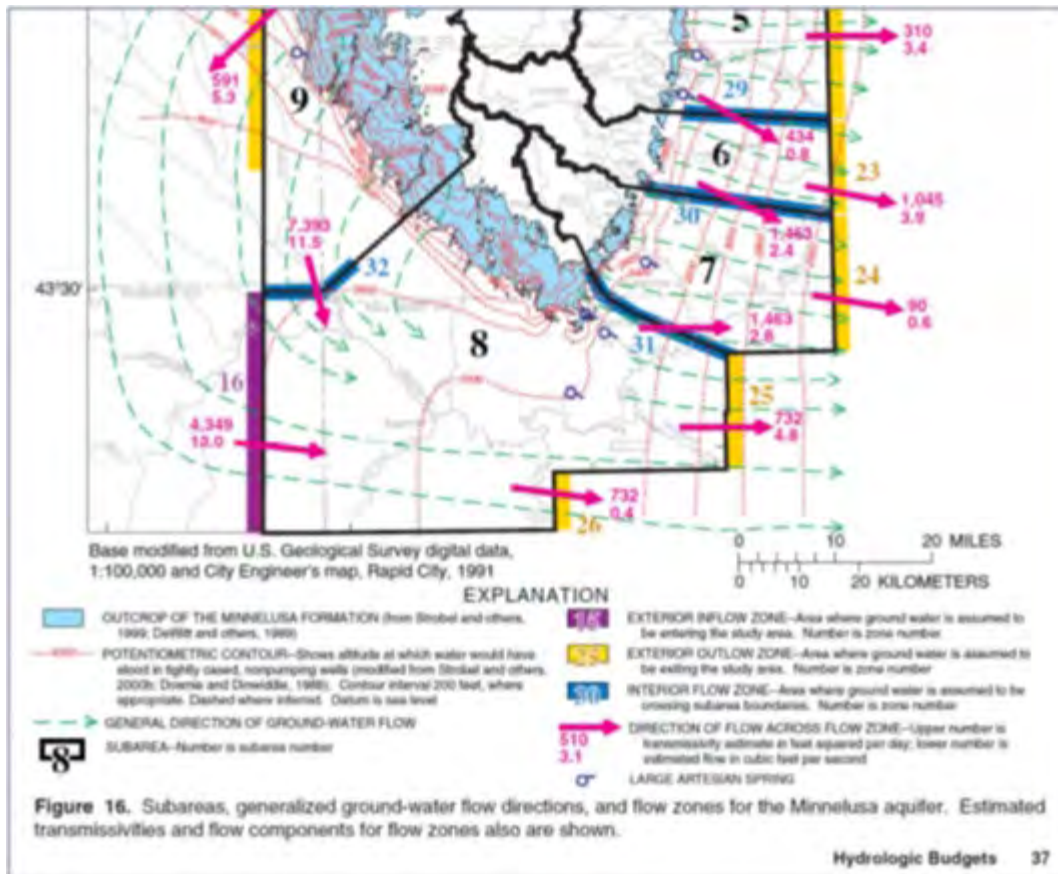

**Figure M. Minnelusa aquifer groundwater flow directions around the southern portions of the Black Hills based on Figure 16 from Carter et al., 2001.**

Based on aquifer flow direction information, the groundwater flowing from the Dewey-Burdock site will not reach Buffalo Gap. Because the proposed Dewey-Burdock operations will have no impact on the aquifers present at Buffalo Gap, EPA does not agree that the geographic scope of the EJ Analysis should be revised to include the Town of Buffalo Gap. For the same reason, EPA does not agree that it would be appropriate to extend enhanced public participation and outreach specifically to the residents of Buffalo Gap.

- 238. Geographic Scope - White Mesa Mill: commenters state that the EJ Analysis acknowledges that the White Mesa Mill area is 49% American Indian and Native Alaskan, yet fails to conduct adequate cumulative effects or EJ analyses of the environmental or EJ impacts associated with the Dewey-Burdock uranium mine byproduct materials potentially being processed at the White Mesa Mill.**

Response #238:

EPA does not agree that it would be appropriate to extend the EJ Analysis to include an EJ assessment of the potential impacts of EPA's actions on the communities near the White Mesa facility. The EJ Analysis reflects the Cumulative Effects Analysis assessment of the appropriate geographic scope of the extent of

potential environmental impacts associated with EPA's SDWA action. As explained in Responses #330 and #331 below, EPA does not agree that the permanent disposal of solid byproduct waste taken off-site must be considered under 40 CFR § 144.33(c)(3). This provision requires EPA to consider the cumulative effects "of drilling and operation of additional wells." The issues required to be considered are limited to those potential environmental effects at or near the project site that occur close in time with the drilling and operation of the injection wells. For this reason, while EPA's draft CEA included a summary of NRC's information on White Mesa Mill, it was for informational purposes only. Additional analysis of the White Mesa Mill or any other potential disposal facilities beyond the Dewey Burdock site is not required. The potential use of the White Mesa Mill or other facility to dispose of 11e.2 byproduct material is later in time and too far away from the injection wells to be reasonably considered as cumulative effects under this regulation. EPA's response to the comment that the CEA should include the White Mesa Mill site can be found at Responses #330 and #331.

The NRC License requires Powertech to have an approved waste disposal agreement in place for 11e.(2) byproduct material disposal at an NRC or NRC Agreement State licensed disposal facility before operations commence, but does not require disposal at a specific facility nor must the facility be specified in the License application. However, because the NRC's Dewey-Burdock Supplemental Environmental Impact Statement (SEIS) indicates that Powertech proposes to pursue an agreement with White Mesa for the disposal of 11e.(2) byproduct material, for information purposes only, EPA cumulative effects and EJ analyses include information on the NRC's assessment of potential environmental impacts at the White Mesa Mill site. In Section 3.13.2 of the SEIS, NRC stated that Utah Department of Environmental Quality prohibits White Mesa from receiving more than 3,823 m<sup>3</sup> [5,000 yd<sup>3</sup>] of ISR wastes from any single source. The NRC further stated that the amount of solid byproduct material generated by an ISR facility, such as the proposed Dewey-Burdock ISR Project, is a small fraction of the tailings generated and disposed of at a conventional mill site. In addition, if the applicant disposes of 11e.(2) byproduct material at the White Mesa Mill, the proposed Dewey-Burdock ISR project would be one of many ISR projects disposing of solid byproduct material at the White Mesa site. The NRC concluded that an addition of ISR byproduct material from the proposed Dewey-Burdock ISR Project to the White Mesa disposal site would not be considered significant.

**239. Geographic Scope: Water Impacts at the Pine Ridge and Cheyenne River Indian Reservations: commenters state that the EJ Analysis should be expanded to include the Pine Ridge and Cheyenne River Indian Reservations because they are located downstream of the project site and could thus be impacted by the EPA-authorized injection and aquifer exemption decisions. One commenter stated that the Project Area is up-gradient and serves as a headwaters zone for watersheds to the east, and that the Cheyenne River flows from the Project Area along the northwestern corner of the Pine Ridge Indian Reservation and serves as the southern boundary of the Cheyenne Reservation before joining the Missouri River. Another commenter stated that the Cheyenne River Sioux Tribe's drinking water source is located near the Cheyenne River's confluence at Lake Oahe and the Cheyenne River flows through the Black Hills very close to the site of the proposed Dewey Burdock Uranium Mine. Commenters state that surface water that flows from the Black Hills and the mine site connects to the surface waters on the Pine Ridge Reservation, including Wounded Knee Creek.**

Response #239:

### **Summary**

As explained in more detail below, EPA analyzed the potential impacts of its SDWA actions to surface water and groundwater and concluded that it would not be appropriate to extend the scope of the EJ Analysis to include the Pine Ridge and Cheyenne River Indian Reservations. Class III injectate from the Dewey-Burdock Project Area will not have any impact outside of the aquifer exemption zone, and therefore will not impact groundwater aquifers underlying the Pine Ridge Indian Reservation 46 miles from the Project Area or the Cheyenne River Indian Reservation 120 miles from the Project Area. Class V injectate from the Dewey-Burdock Project Area would take over 100,000 years to reach the Minnelusa aquifer beneath the Pine Ridge and Cheyenne River Indian Reservations, and thus, will have no impact to groundwater quality underlying the Pine Ridge and Cheyenne River Indian Reservations.

Further, as discussed below, there will be no surface water impacts from either the Class III or the Class V injectate to the Cheyenne River, the Cheyenne River Indian Reservation, the Pine Ridge Indian Reservation, or other downstream communities. The point source discharges from the project to surface waters will be from construction and industrial stormwater flows and must comply with South Dakota DENR's construction and industrial stormwater NPDES permits. Under Section 402 of the Clean Water Act and its implementing regulations, those permits must ensure that permitted discharges do not cause or contribute to exceedances of South Dakota's surface water quality standards. Under Section 303(c) of the Clean Water Act, water quality standards must "protect the public health or welfare, enhance the quality of water and serve the purposes of [the Act]." Moreover, those standards reflect EPA's Section 304(a) national recommended water quality criteria, which themselves reflect the latest scientific knowledge of the identifiable effects on health and welfare of pollutants in water. The nearest Indian Reservation to the Project Area is the Pine Ridge Indian Reservation, which is approximately 46 miles from the Project Area. The Cheyenne River Indian Reservation is approximately 120 miles from the Project Area. As the surface water discharges flow downstream from the regulated point of discharge, they will be subject to dispersion, dilution and other forms of natural attenuation. As a result, if any concentrations of pollutants from the Project Area reach the Reservations, they will be in lower concentrations than at the regulated point of discharge and, therefore, will be lower than EPA's 304(a) national recommended criteria, which are developed to protect water quality and human health.

Thus, because EPA has determined that there will be no potential impacts to surface water or groundwater on either of these Indian Reservations, EPA has not revised the geographic scope of the EJ Analysis and the EJSCREEN considerations to extend to the Pine Ridge or Cheyenne River Indian Reservations.

### **Injection Authorized by the Class III Permit Will Not Impact Surface Waters on the Cheyenne River or the Pine Ridge and Cheyenne River Indian Reservations**

#### Vertical Containment of Class III Injection Interval Fluids

The Dewey-Burdock Project Site is located in the Cheyenne River basin. The Class III Area Permit includes two types of requirements to maintain vertical containment of ISR injection interval fluids, preventing them from reaching the ground level and impacting the Cheyenne River. The Class III Area Permit requires corrective action for any existing breaches in confining zones and mechanical integrity

requirements for injection, recovery and monitoring wells at Class III ISR wellfields to prevent breaches in confining zones from improper well construction.

The Class III Area Permit requires the Permittee to identify and perform corrective action on any breaches in confining zones in Class III ISR wellfield areas, including improperly plugged historic exploration boreholes and private wells, that could serve as pathways for Class III injection zone fluids to reach the ground level. If a confining zone breach is not able to be located or repaired, the Permittee must demonstrate that Class III injection zone fluids are contained through operational controls and monitoring. These requirements are found in Part III of the Class III Area Permit and discussed in Section 6.0 of the Fact Sheet for the draft Class III Area Permit.

Part VII, Section B of the Class III Area Permit requires the Permittee to demonstrate initial mechanical integrity of all injection and production wells and maintain mechanical integrity through the life of each injection well. Part II, Section D.4.e. of the Class III Area Permit requires demonstration of initial mechanical integrity for monitoring wells. External mechanical integrity is demonstrated through evaluation of well cementing records demonstrating there are no pathways through the cement between the well casing and borehole for injection interval fluids to travel through to reach USDWs or the ground level.

#### Horizontal Containment of Class III Injection Interval Fluids

The Class III Area Permit also requires the Permittee to maintain and demonstrate horizontal control of injection interval fluids within each wellfield during ISR operations and groundwater restoration. This requirement is intended to prevent ISR contaminants from impacting the USDW outside the aquifer exemption boundary. Horizontal control is maintained by injecting a smaller volume of water into the wellfield than is being removed by the production wells. Horizontal control is demonstrated through excursion monitoring as discussed in Section 12.5 of the Fact Sheet for the draft Class III Area Permit and by continuous monitoring of the injectate flow volume and the recovery flow volume for each wellfield as required in Part IX, Section B, Table 14.A of the Class III Area Permit.

After ISR operations, groundwater restoration and post-restoration stability monitoring of the injection interval groundwater have been completed, the UIC Class III Area Permit requires the Permittee to demonstrate in a Wellfield Closure Plan that ISR contaminants will not cross the downgradient aquifer exemption boundary and impact USDWs within the Dewey-Burdock Project Site. Therefore, no ISR contaminants will impact any downgradient portions of the Inyan Kara aquifer where Inyan Kara groundwater may recharge the Cheyenne River.

Based on the protective requirements of the Class III Area Permits, EPA has concluded there will be no surface water impacts from Class III injection activity to the Cheyenne River, the Cheyenne River Indian Reservation, the Pine Ridge Indian Reservation, or other downstream communities.

#### **Injection Authorized by the Class V Permit Will Not Impact the Cheyenne River or the Pine Ridge and Cheyenne River Indian Reservations**

The Class V Area Permit authorizes the injection of treated ISR waste fluids into portions of the upper Minnelusa Formation. The Permittee must demonstrate through water quality sampling and analysis that the Minnelusa injection zone does not meet the definition of USDW. Response #120 above summarizes EPA's analysis of the groundwater flow in the Minnelusa aquifer and explains that the



locations where the Minnelusa groundwater flows to the ground surface are at springs near the Minnelusa outcrop around the Black Hills. Figure N shows the elevation of the top of the Minnelusa Formation from the Sheet 2 map from Carter and Redden, 1999. (Carter and Redden, 1999, Sheet 2) The springs are located in the green circle in Figure N; the Dewey-Burdock Project Area is located inside the blue square. The Minnelusa Formation where the springs are located, occurs at a higher elevation than the Minnelusa injection zone in the Dewey-Burdock Project Area. Although the Minnelusa Formation top elevation is not the same as the aquifer groundwater level and the direction of the Minnelusa Formation dip is not exactly the same as the groundwater flow direction, relative formation top elevation and direction of formation dip are a useful approximation in this case. EPA concludes that injectate flowing from the Dewey-Burdock Project Site would have to flow uphill/upgradient to reach these springs and thus would not reach the locations of these springs. In addition, the Cottonwood, Chilson and Cascade anticlines located south of the Black Hills are like hills raising the Minnelusa Formation top to a higher elevation and deflect Minnelusa groundwater flow further south away from the locations of these springs.

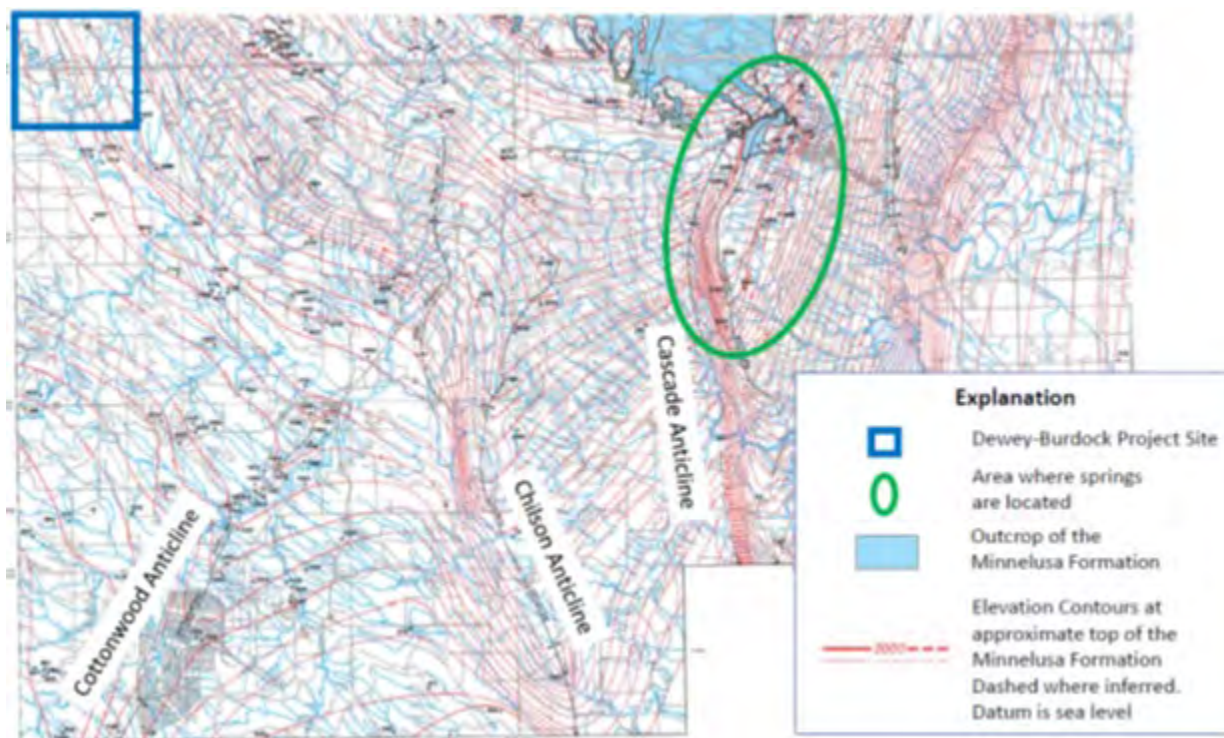

**Figure N. Elevation of the Minnelusa Formation top surface (Source: Carter and Redden, 1999, Sheet 2)**

Based on this analysis, EPA concludes the Class V disposal well injectate will not travel to the locations of Minnelusa springs to be discharged to the ground surface; therefore, Class V injection activities will not impact surface water, including the Cheyenne River, the Cheyenne River Indian Reservation, the Pine Ridge Indian Reservation, or other downstream communities.

**Authorized Injection Will Not Impact Wounded Knee Creek on the Pine Ridge Indian Reservation**

In addition to the explanation above, Figure O below is a screen shot of the South Dakota Surface Water Quality Standards map (click on [Impairment Status](#) tab). The green-dash lines are river drainage basin

boundaries. The enlarged portion of the map shows that Wounded Knee Creek is located in the White River drainage basin. The Dewey-Burdock site is located in the Cheyenne River basin and there is no surface water connection between the Dewey-Burdock Project Site and the White River drainage basin. Based on the geography of the White River drainage basin, it does not receive surface water originating from the Black Hills. Therefore, the Dewey-Burdock Project will not affect the White River drainage basin including the area around Wounded Knee Creek.



**Figure O. Screenshot of the South Dakota Surface Water Quality Standards map (Impairment Status tab) showing drainage basin boundaries as green-dashed lines.**

**Authorized Injection Will Not Impact the Arikaree and Ogallala Aquifers on the Pine Ridge Indian Reservation or the Inyan Kara and Minnelusa Aquifers on the Pine Ridge and Cheyenne River Indian Reservations**

As discussed above, the Class III Area Permit requires the Permittee to maintain and demonstrate horizontal control of injection interval fluids within each wellfield during ISR operations and groundwater restoration so ISR contaminants will not impact the USDW outside the aquifer exemption boundary. The UIC Class III Area Permit also requires the Permittee to demonstrate that the ISR wellfield closure will not result in ISR contaminants crossing the aquifer exemption boundary within the Dewey-Burdock Project Site. Therefore, no ISR contaminants will impact any downgradient portions of the Inyan Kara aquifers, including portions underlying the Pine Ridge and Cheyenne River Indian Reservations or any other Inyan Kara groundwater located downgradient from the Dewey-Burdock Project Site.

EPA investigated groundwater flow directions in the Minnelusa aquifer relative to the Pine Ridge and Cheyenne River Reservations. Figure P is a groundwater flow direction map from Figure 17 in Driscoll et al., 2002. This map shows the direction of groundwater flow in the Minnelusa aquifer from its recharge



area in the Black Hills to a discharge area identified in this paper. As shown in the map in Figure P, the authors hypothesize that the Minnelusa aquifer groundwater flows from the Dewey-Burdock site and around the southern end of the Black Hills toward the Williston Basin, crossing underneath the northwestern portions of the Pine Ridge Reservation. The map shows a discharge area for the Madison and Minnelusa aquifers in an area that coincides with the eastern portion of the Cheyenne River Indian Reservation.

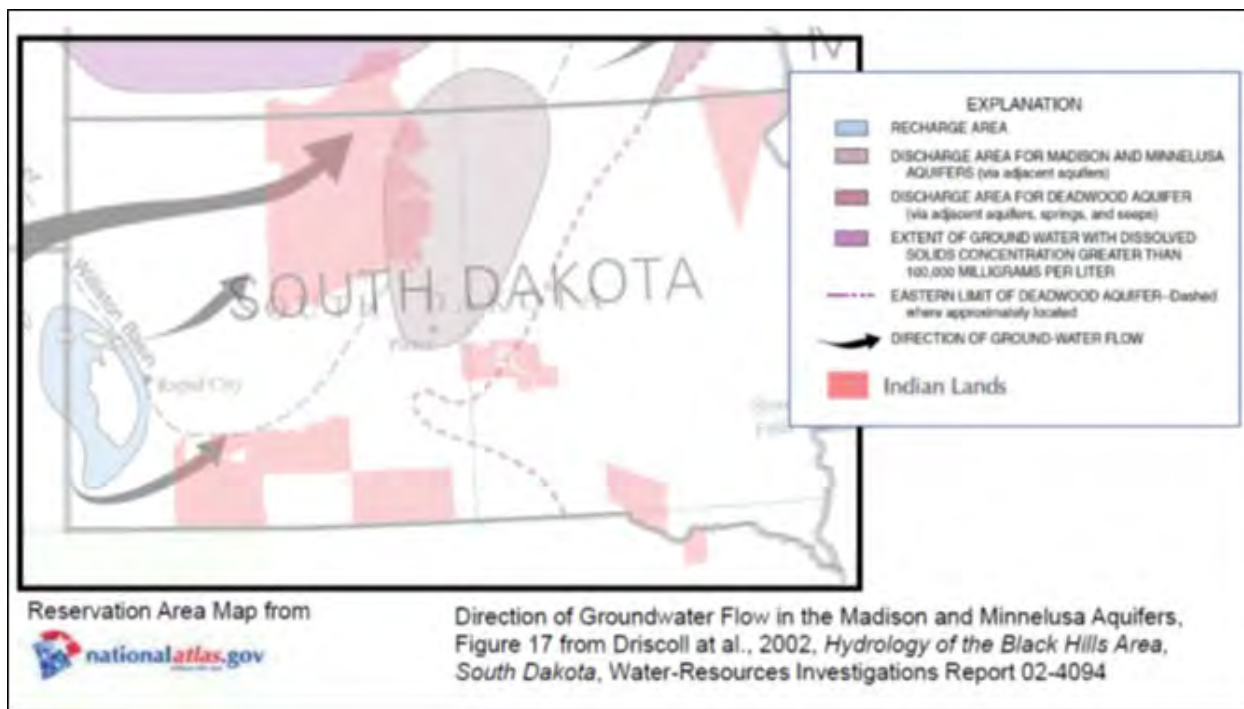

**Figure P. Minnelusa aquifer groundwater flow direction map from Figure 17, Driscoll et al., 2002**

EPA examined oil and gas test wells located near the northwest portion of the Pine Ridge Indian Reservation to determine the depth of the Minnelusa aquifer in the area and found the top of the Minnelusa aquifer is more than 3,800 feet below ground level in this area, which is too deep to flow to ground level. Springs emanating from, or passing through, the Minnelusa aquifer occur where the top of the Minnelusa aquifer occurs closer to the ground level. For example, at the springs shown in Figure Q, from Figure 8 of Naus et al. 2001, the top of the Minnelusa is approximately 200 feet or less below ground level, based on nearby private well logs. Based on the elevation of the top of the Minnelusa Formation shown in Carter and Redden, 1999, the springs occur in areas located at a higher elevation than the Minnelusa injection zone at the Dewey-Burdock Project Site. Carter and Redden, 1999, provides estimates of how the Chilson and Cascade anticlines affect the Minnelusa Formation elevation. As a result, the flow path of Class V injectate would be deflected to the south and would essentially have to flow uphill to reach these springs where Minnelusa groundwater flows to the surface.

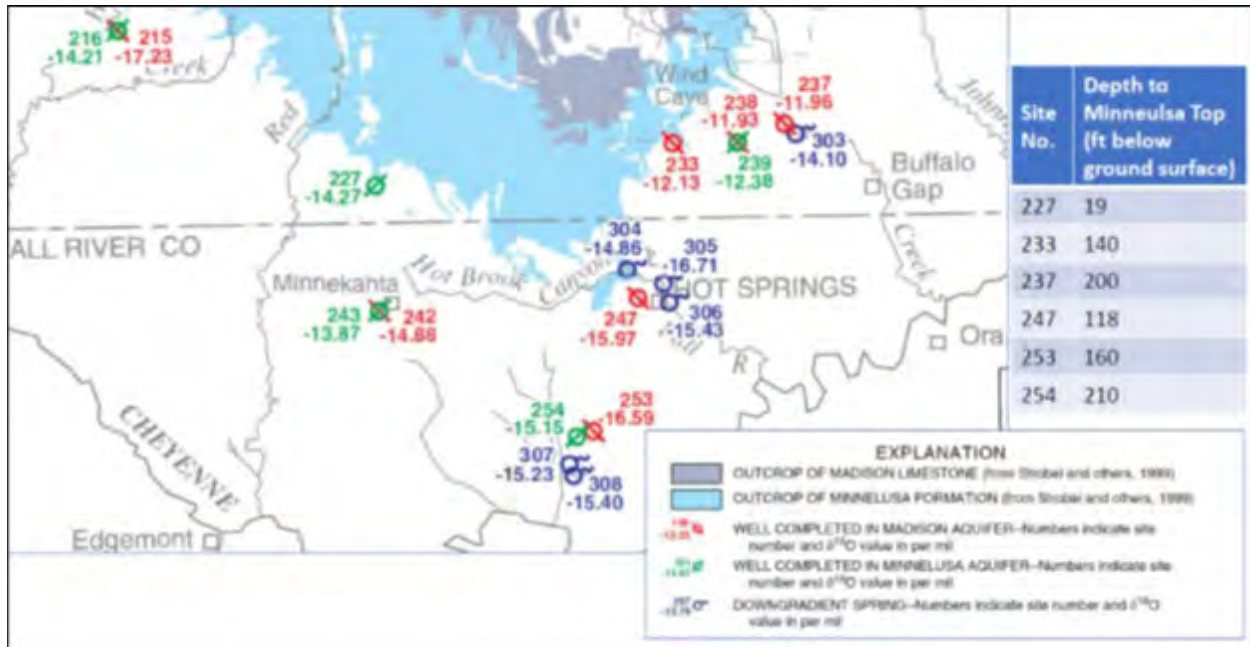
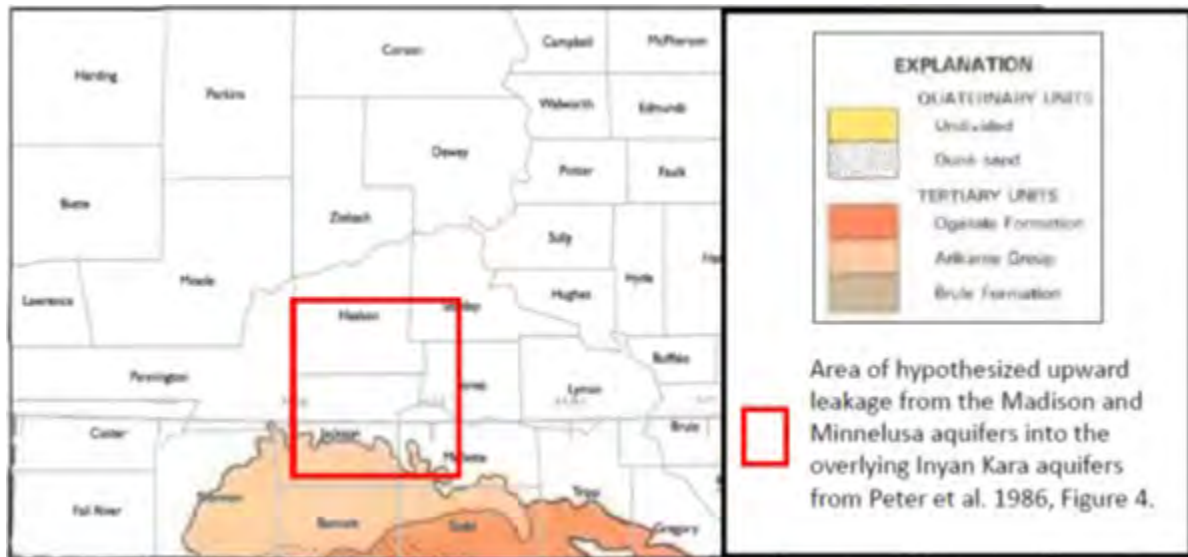

Figure Q. Locations of springs emanating from or passing through the Minnelusa aquifer, from Figure 8 of Naus et al., 2001.

Based on lineament analysis and review of Inyan Kara groundwater quality data, Peter et al., 1986, hypothesized upward leakage from the Madison and Minnelusa aquifers into the Inyan Kara aquifers in an area within portions of Jackson, Melette, Haakon, Stanley and Jones Counties in South Dakota. (Peter, K.D., et al., 1986, *Lineaments: Significance, Criteria for Determination, and Varied Effects on Ground-Water Systems—A Case History in the Use of Remote Sensing*, Geotechnical Applications of Remote Sensing and Remote Data Transmission, ASTM STP 967, A. I. Johnson and C. B. Petterson, Eds., American Society for Testing and Materials, Philadelphia, 1988, pp. 46-68.) Figure R shows the location of this area overlaid on a map of the Arikaree and Ogallala aquifers in South Dakota documented in Weeks, et al., 1988. (Weeks, J.B., et al, 1988, *Summary of the High Plains Regional Aquifer-System Analysis In Parts of Colorado, Kansas, Nebraska, New Mexico, Oklahoma, South Dakota, Texas, and Wyoming*, USGS Professional Paper 1400-A, at p. A4) Upward leakage from these lower aquifers into the Inyan Kara aquifers does not necessarily result in upward leakage into the overlying Arikaree and Ogallala aquifers in this location. EPA reviewed logs from oil and gas test wells in Jackson County and determined the top of Inyan Kara is 2800 to 2900 feet below ground surface. Approximately 2000 feet of overlying strata, most of which are confining zones, separate the top of Inyan Kara aquifer from the Arikaree and Ogallala aquifers. EPA concludes that Inyan Kara groundwater does not flow into the Arikaree and Ogallala aquifers on the Pine Ridge Indian Reservation.



**Figure R. Map showing area of possible upward leakage from the Madison and Minnelusa aquifers into Inyan Kara aquifers and extent of the Arikaree and Ogallala aquifers (Sources: Peter et al., 1986, Figure 8 and Weeks, et al., 1988, Figure 1)**

EPA has investigated the area identified as a discharge area for the Minnelusa and Madison aquifers in the area shown in Figure P that coincides with the eastern portion of the Cheyenne River Reservation. The discharge area represents the area where Madison and Minnelusa groundwater is moving upward into the Inyan Kara aquifers (Downey, J.S and Dinwiddie, G.A, 1988, *The Regional Aquifer System Underlying the Northern Great Plains in Parts of Montana, North Dakota, South Dakota, and Wyoming-Summary*, USGS Professional Paper 1402-A). Based on oil and gas test well logs EPA reviewed, the depth to the top of the Minnelusa aquifer in the area of discharge is approximately 3,000 feet below ground level and the top of the Inyan Kara aquifer is approximately 2,000 feet below ground level. According to Howells, 1979, (Sheet 1) the Pierre Shale is present at the surface of the eastern portion of the Cheyenne River Indian Reservation. (Howells, L., 1979, *Geohydrology of the Cheyenne River Indian Reservation, South Dakota*, USGS Hydrologic Investigations Atlas HA-585, Sheet 1) Most of the intervening geologic units between the top of the Inyan Kara, including the Pierre Shale, are confining units. Based on this information, EPA concludes that neither the Minnelusa nor the Inyan Kara injection zones discharge to ground level at the Cheyenne River Indian Reservation. EPA examined test oil and gas well logs and found that along the eastern edge of the Cheyenne River Indian Reservation the top of the Inyan Kara ranges from 1500 in the southeast to 2800 in the northeast. The top of the Inyan Kara deepens from south to north as it descends further into the Williston Basin. Driscoll et al., 2002, characterizes Inyan Kara groundwater as moderately saline with increasing salinity toward the deep parts of the Williston and Powder River Basins. Because of the depth and salinity of the Inyan Kara aquifers at the Cheyenne River Indian Reservation, these aquifers would not be developed for use.

Using the most conservative aquifer parameters to calculate the fastest possible travel time for Minnelusa groundwater flow, EPA calculated travel times for the Class V injectate to travel through the Minnelusa injection zone and reach the Pine Ridge and Cheyenne River Indian Reservations. According to EPA calculations, it would take 108,000 years for the Class V injectate to reach the western border of the Pine Ridge Indian Reservation and 258,000 years to reach the southwestern corner of the Cheyenne River Indian Reservation. Traveling this distance over this amount of time, the Class V injectate would no

longer be distinguishable due to dispersion and dilution within the aquifer. Howells (1979) characterizes the Minnelusa aquifer as major groundwater reservoir, which means it contains a large volume of water, but yields saline to very saline water.

EPA concludes that Class III injectate from the Dewey-Burdock Project Site will not have any impact outside of the aquifer exemption zone, and therefore will not have any impact on groundwater aquifers underlying the Pine Ridge and Cheyenne River Indian Reservations. Further, EPA concludes that Class V injectate from the Dewey-Burdock Project Site will not impact groundwater quality in the aquifers underlying the Pine Ridge and Cheyenne River Indian Reservations.

**240. Comment I.E. Geographic Scope – Potential Impacts to Water Resources in the Black Hills: one commenter asserts “there are underground water channels or chambers in the Black Hills region that reach the Oglala Aquifer and the injection wells with toxic chemicals or substances could harm water sources, wells and supplies that are used by humans within the Treaty Boundaries.”**

Response #240:

It is not clear what water channels or chambers the commenter is referring to that would hydraulically connect aquifer in the Black Hills area to the Ogallala aquifer. EPA is aware of the cave system in the Madison aquifer and the fact that the caves have not been mapped to their fullest extent. As discussed in Section 3.3.2 of the 2019 Fact Sheet for the draft Class V Area Permit and in Response #11 above, EPA has examined oil and gas test well logs to analyze the thickness and continuity of the lower Minnelusa confining zone that separates the Minnelusa injection zone from the underlying Madison aquifer. EPA has determined that this confining zone is adequate to prevent any contamination of the Madison aquifer from injection activities in the Minnelusa aquifer. Therefore, EPA has determined that the Minnelusa injection zone fluids at the Dewey-Burdock site will not impact the Madison aquifer or the Madison cave system. Response #239 above discusses the analysis supporting EPA’s conclusion that that injection into Inyan Kara aquifers will not impact the Ogallala aquifer.

**241. Comment I.F. Geographic Scope – Tribal Member Health Impacts at the Pine Ridge and Cheyenne River Indian Reservations: commenters assert that the EJ Analysis should consider health impacts to members of the Oglala Sioux Tribe on the Pine Ridge Indian Reservation and the Cheyenne River Sioux Tribe on the Cheyenne River Indian Reservation. They state that hazardous projects like the Dewey-Burdock mining project have been disproportionately located near Native American lands and will most heavily impact indigenous people on the Pine Ridge Indian Reservation. Commenters are concerned that EPA’s approval decisions would expose the Lakota Oyate to the devastating health impacts associated with uranium mining.**

Response #241:

EPA analyzed the cumulative environmental effects from EPA’s actions - including surface water, groundwater and air impacts – and determined that the farthest environmental impacts (modeled air impacts) would potentially extend 20 miles from the project area (see Response #239 above for more

information on surface and groundwater impacts). The nearest Indian Reservation to the project area is the Pine Ridge Indian Reservation, which is approximately 46 miles from the site. The Cheyenne River Indian Reservation is approximately 120 miles from the project site. None of the environmental impacts or associated health effects are projected to reach either the Pine Ridge or Cheyenne River Indian Reservations. Thus, EPA has not revised the geographic scope of the EJ Analysis and the EJSCREEN considerations to include assessment of environmental or health impacts at the Pine Ridge or Cheyenne River Indian Reservations.

**242. Comment I.G. Geographic Scope – Socioeconomic Considerations for Tribal Members Residing in the Black Hills: the commenter states the EPA should analyze the socioeconomic status of Lakota residents who live in the Black Hills as an impacted population based on income, health, life expectancy, housing and other measures.**

Response #242:

EPA considered the farthest potential environmental impacts from the Agency's SDWA actions to determine the appropriate geographic scope of both the EJ and cumulative effects analyses. EPA considered a 20-mile screening area to be an appropriate Study Area for the EJ Analysis based on air modeling showing potential detectable air impacts above background levels reaching 20 miles from the project area.

EPA conducted an EJSCREEN analysis for a 20-mile radius around the project area based upon the various demographic and environmental indicators discussed in the EJ Analysis. Based on comments received on the 2017 Draft EJ analysis, in 2019, EPA issued a Revised Draft EJ Analysis for the Proposed UIC Permitting Actions for the Dewey-Burdock Uranium In-Situ Recovery Project in the Southern Black Hills Region of South Dakota (2019 Revised Draft EJ Analysis). In addition to the analysis of the 20-mile Study Area, the 2019 Revised Draft EJ Analysis expanded the scope of the EJ analysis in two ways: 1) to include consideration of tribal spiritual and cultural interests in the Black Hills which, in its entirety, extends beyond 20 miles from the project area; and 2) although the formal Indian Reservations of potentially affected Indian tribes are located well beyond the 20-mile radius, the revised analysis considers tribal spiritual and cultural interests in the Black Hills regardless of where the tribal members may permanently reside. EPA recognizes that many tribes and tribal members hold spiritual and cultural interests in the Black Hills, and EPA thus revised the EJ analysis to include consideration of the Black Hills as a sacred site to Native American tribes. However, the EJ Analysis maintains the 20-mile radius for the EJSCREEN analysis of demographic, socioeconomic and environmental indicators because the analysis is based upon the farthest potential environmental impacts (related to the 11 environmental indicators in EJSCREEN) from EPA's action. Populations, including Tribal members, residing within the 20-mile radius of the EJ Analysis are included in the EJ Screen.

**Comments on the Black Hills as a Sacred Site**

**243.**

**a. The Black Hills are Sacred to Many Tribal Nations and Tribal Members**

During consultation discussions with Tribal governments and the 2017 and 2019 public comment periods, the EPA received numerous comments describing the Black Hills as a sacred site with important cultural, spiritual and religious significance to many Tribal Nations and Tribal members. Several of the comments from Tribal governments, Tribal members and other interested stakeholders capture common themes and are quoted below.

**“The Black Hills of South Dakota constitute among the most sacred lands to the Lakota people from time immemorial. We call the Black Hills Wamaka Og’naka I’Cante or ‘the heart of everything that is.’ It is called this because the Black Hills contain the most important religious sites of the Lakota People, including the site where Lakota people believe that our people emerged onto this earth, and sites where the Lakota people have performed annual religious ceremonies and pilgrimages since before recorded history and through today.”**

**“The Black Hills are sacred to the Lakota, much like Jerusalem is to the Jews or the Vatican is to Catholics. Sacred cultural and historical resources must be fully protected and doing this relies on the involvement of knowledgeable Lakota people, plenty of time, adequate finances, and the willingness to put the sacred above the dollar. Some places should not be subjected to uranium mining. Lakota people who are sharing their ancient knowledge, which they have spent a lifetime learning, should be offered compensation for their efforts and given credit for resulting information. . . . Lakota people say “Mni Wiconi” which roughly translates to “Water is Life.” Anything that threatens our water in any form in this semi-arid region is of immediate concern due to the need for water, our spiritual connection to water, and the status of the area’s water under treaty law. Lakota people and their allies have a history of protecting water resources from uranium mining, and we will continue to do so.”**

**“Crazy Horse told his people he wanted them to remember him whenever they saw the Black Hills. This is sacred land. Visitors to this area come for contemplation, rejuvenation, and inspiration. I believe strongly in the value of our natural environment. These treasures must be protected as unique and important to our history, the people who live in the Black Hills, travelers to the area, the larger environment, and the people of the world.”**

**“The sacred nature of the Black Hills to the Oceti Sakowin Oyate is well documented – these are sacred lands that should not be desecrated in the manner described in the draft UIC permit. The Black Hills are integral to our creation story, and remain an important place for pilgrimage and ceremony by our Tribal members.”**

**“The Black Hills, known as Paha Sapa to the Lakota, are the center of their spiritual and cultural universe. To the Lakota, throughout all of Creation, Paha Sapa has been “The Heart of Everything That Is.”**

**“Lakota medicine man Pete Catches, described the Paha Sapa in 1993: ‘To the Indian spiritual way of life, the Black Hills is the center of the Lakota people. There ages ago, before Columbus came over the sea, seven spirits came to the Black Hills. They selected that area, the beginning of sacredness to the Lakota people... The seventh spirit brought**

the Black Hills as a whole--brought it to the Lakota forever, for all eternity, not only in this life, but in the life hereafter. The two are tied together. Our people that have passed on, their spirits are contained in the Black Hills. This is why it is the center of the universe, and this is why it is sacred to the Oglala Sioux. In this life and the life hereafter, the two are together.”

“The Black Hills or the HeSapa are very sacred for us as they tell of our creation, our traditional teachings, it holds spaces for our spiritual ceremonies, and it provides our natural foods and plant medicines. It is also home to wildlife. This land is our "Church" and where we put our prayer altars -- it is known to us as "The Heart of Everything That Is." The HeSapa holds eons of memory in our DNA and Water is our main entity - Mni Wicozani; Water is Life. Water is Alive. Water is Sacred.”

“... [T]he importance of the Black Hills to the Lakota Nation, that is our birthplace, that is our creation story, that is where we come from.”

“... [I]n that area there's sacred sites, traditional Lakota burial sites as well as different parts of, you know, where you would find historical petroglyphs and different sacred sites like that.”

“... [T]he Black Hills are considered in a historic context, rather than in a modern context that recognizes their continuing importance to the Lakota people.”

... “[T]o Indigenous peoples, contamination of water also raises cultural concerns. To Indigenous peoples, water, in particular, holds special meaning and is regarded as a sacred element. Indigenous cultures all over the world recognize a simple predicate: water is life. Water is identified as the first medicine. It is the first environment in which we live while we are being carried in our mothers. It is an offering made in prayer ceremonies and is a spiritual being in and of itself. All of these factors should be considering in evaluating the requested permits.”

#### **b. Tribal Member Activities and Resource Uses in the Black Hills**

During consultation discussions with Tribal governments and the 2017 and 2019 public comment periods, the EPA also received many comments describing Tribal historic and present-day uses of the Black Hills as a sacred site. Some expressed concern that specific environmental resources and Tribal member uses of those resources may be harmed by the EPA’s action. Several of the comments from Tribal governments, Tribal members and other interested stakeholders capture common themes and are quoted below.

“... [T]he Lakota people lived, hunted, buried our dead, and performed our religious sacraments, including inipi (sweatlodge), hanbleca (vision questing), and other rites throughout our long history in the region. We still use the Black Hills in this way. In light of our long and rich history in this region, as well as our use and occupation of this area through the present day, there are untold sites of historical, cultural, and spiritual significance throughout the Black Hills that require careful consideration.” Furthermore, the Tribe’s reserved water rights themselves constitute a spiritual and cultural resource in

light of the primary role that water plays in Lakota religious sacraments, which require environmentally and ritually pure water.”

“The site of the proposed Dewey-Burdock Uranium Mine is within the Tribe's 1851 territory. Specifically, it is in the vicinity of the Black Hills, among the most sacred sites to the Lakota people. Our people lived in this area, hunted in this area, and made religious pilgrimages in this area from time immemorial.”

“The Black Hills are integral to our creation story, and remain an important place for pilgrimage and ceremony by our Tribal members. They are the spiritual center for the Lakota and Dakota Nation. The late David Blue Thunder, a prominent Sicangu ceremonial leader, explained that “The Black Hills are the heart of our home, and the home of our heart.” (S. Hrg. 99-844, p. 234, statement of David Blue Thunder). It is akin to Jerusalem or Bethlehem, for Christianity and Judaism. It is unlikely that EPA would suggest that uranium mining waste be permitted to be injected into disposal wells at those sacred places. EPA should not permit injection wells for uranium mining wells at the Dewey Burdock project location in the Black Hills.”

“Water is an essential component of one of our most important religious sacraments – the inipi ceremony or sweat lodge. This sacrament requires that we use only water that is both environmentally and ritually pure. As noted above, the Tribe has very limited access to water on the Reservation and relies solely on water drawn from the confluence of the Cheyenne River and the Missouri River at Lake Oahe for its drinking water and which represents reserved water rights of the Tribe. Upstream contamination of these waters in which the Tribe owns reserved water rights has the very serious potential to affect the Tribe's and its members' religious exercise in violation of the Religious Freedom Restoration Act.”

“Sacred site wisdom tied to star knowledge and ongoing spiritual practice intellectually, culturally, and spiritually belongs to the Lakota people. Lakota people have ancient connections to the Black Hills, including the Dewey Burdock winter camp area: sacred sites above and below ground, caves, fault lines, and ancient migration sites. Elders and spiritual practitioners have vast knowledge far beyond the comprehension of the Western education system, and this knowledge cannot be appropriated, diminished, or dismissed.”

“Traditional ceremonial activities which demonstrate the sacred nature of Black Hills to tribes include: Personal Rituals: Prayer offerings (bundles and cloths), sweatlodge ceremonies, vision quests, funerals. Group Rituals: Sun Dance. Sacred Narratives: Origin legends, legends of culture heros, and legends of the origins of ceremonies and sacred objects. Today we are seeking to: (1) continue our religious practice as we have traditionally (2) maintain the land that has ancestral significance and provides deep ties to our culture that has been severely affected by colonization and American expansion, (3) preserve the land in its natural state and maintaining its deep, religious connections, and finally, (4) protect and preserve the soil – it is the foundation of healthy land and water.”

“This is our church, this whole Black Hills area, from the top to the bottom. And the reason I know this is because my grandmas, we come from Oglala, and we gather -- we gather our



plants and fruits and vegetables, and everything is provided for us here. and we still make our trek here and gather our fruits and our vegetables, our food and our medicines. And you know what? Whew. I -- I have a friend that lives in this area, and I gathered some tipsila, which is our fruit. They are all deformed. They are all sick. So we can't come here and gather our food there. They destroyed it, and they want to keep destroying it. That we got this water over here in Hot Springs. They call it kidney water, and it comes right from this aquifer, Inyan Kara, and this is sought-after water. It's healing water. And this is the same water these guys here want to contaminate and claim."

"I do a lot of medicinal herbs, like a botanist, but I brought some plants and herbs here that I study. And through my great-grandfather and some uncles of mine, they taught me the study of plant life.

I have five plants here that grow within the Black Hills and the reservation lands. And one time out of every year, we go to harvest these. This is -- it's called -- you call it kinnikinnick. It's the bark and the inner layer of the chokecherry tree that we dry and we smoke in our pipes. It's nonchemical. There's no chemicals in it. It's natural. And my grandfather used to say when you smoke that, you smoke it with reverence and respect to Mother Earth. And there's actually healing properties in all these plants. And he says, the kinnikinnick, if you smoke it without the medicinal -- without the chemicals in it, it has a healing power for your lungs and your upper gastric system.

And I also have sage. And a lot of you do use sage, I know, a lot of cooking. For us, we make tea out of it, and that's also good for your upper gastric and your gastrointestinal.

If you allow this injection or the pollution of our land to continue, you will make our plants sick also. And with that, it won't work for us because plants are our powerful medicine. You have to believe in it, and that's where the pharmaceutical people get their knowledge from, is our plants."

Response #243:

EPA appreciates the information provided to the Agency on this topic and recognizes that the Black Hills are sacred to many Tribal Nations and Tribal members. During Tribal consultation discussions, many Tribal government representatives described the important cultural, spiritual and religious significance of the area to Tribal governments and their members. EPA also received comments from Tribal governments, Tribal members and other interested parties on this topic during the two public comment periods on the draft UIC permits. Tribal governments and commenters describe the cultural and spiritual significance of the Black Hills, as well as their historic and present-day activities and resource uses. The Agency has also reviewed published studies and analyses prepared by other federal agencies on the cultural significance of the Black Hills. The EJ Analysis has been revised to reflect the additional information received by the Agency.

In summary of the Section II.A. and II.B. comments, with respect to potential impacts to physical resources in the Black Hills, input from Tribal governments and commenters reflect concerns that EPA's approval of Underground Injection Control permits would contaminate the surface water and groundwater underlying the Black Hills. Commenters also raise concerns about present-day uses of water resources, including the use of water to grow fruits and vegetables for human consumption as

well as plants and herbs for medicinal purposes; and the use of water for ceremonial purposes, including for sweatlodges. In addition, Tribal Nations and Tribal members assert that regardless of whether the UIC activity is protective of underground sources of drinking water (USDWs), as required by the SDWA, allowing injection of contaminants into the groundwater underlying any portion of the historic Black Hills is an affront to, and adversely impacts, Tribal cultural and spiritual interests in the sacred site.

### Water Resources

Within the scope of the SDWA authorities, in developing the Class III and Class V Area Permits, EPA took into consideration that the Dewey-Burdock Project Site is located in the southern Black Hills, an area sacred to a number of Tribal Nations, and that the deep well injection zone is located above the Madison Formation, which serves as a source for public drinking water systems. The extensive permit requirements in the Area Permits ensure the protection of underground sources of drinking water, including those on which commenters place special importance. Specifically, the permits contain protective requirements, including: extensive evaluation and characterization of injection zone and confining zone hydrogeologic conditions; protective injection well construction and operating requirements; and extensive monitoring programs that are designed to detect any threat to USDWs in a timely manner so that the Permittee can implement mitigation measures, if necessary, before USDWs are affected. The Permittee must demonstrate in a Wellfield Closure Plan that no ISR contaminants will cross the aquifer exemption boundary. The UIC permit conditions prevent the migration of fluids to the Inyan Kara USDW outside the aquifer exemption area, thus protecting against endangerment of the USDW with respect to all potentially-affected communities. Response #239 in this document provides additional information on these UIC permit requirements.

As described in more detail in Response #239, with respect to potential impacts to water resources in the Black Hills, Class III injectate from the Dewey-Burdock Project Area will not have any impact outside of the aquifer exemption zone, and therefore will not impact groundwater aquifers underlying the Black Hills. Because no injection can occur under the Class V Area Permit unless the Minnelusa aquifer is not an underground source of drinking water (USDW), EPA has determined that there will be no adverse impacts to USDWs from its UIC permit authorizations. There will be no surface water impacts from either the Class III or the Class V injectate to the Black Hills. The point source discharges from the project to surface waters will be from construction and industrial stormwater flows and must comply with South Dakota DENR's construction and industrial stormwater NPDES permits. Under Section 402 of the Clean Water Act and its implementing regulations, those permits must ensure that permitted discharges do not cause or contribute to exceedances of South Dakota's surface water quality standards. Under Section 303(c) of the Clean Water Act, water quality standards must "protect the public health or welfare, enhance the quality of water and serve the purposes of [the Act]." Moreover, those standards reflect EPA's Section 304(a) national recommended water quality criteria, which themselves reflect the latest scientific knowledge of the identifiable effects on health and welfare of pollutants in water. As the surface water discharges flow downstream from the regulated point of discharge, they will be subject to dispersion, dilution and other forms of natural attenuation. As a result, if any concentrations of pollutants from the Project Area reach the Black Hills, they will be in lower concentrations than at the regulated point of discharge and, therefore, will be lower than EPA's 304(a) national recommended criteria, which are developed to protect water quality and human health. Response #239 in this document provides additional information on the extent of potential surface and groundwater impacts.

### Water Uses and Activities

Comments raise concerns about potential impacts from EPA's actions on present-day activities and uses of the water resources in the Black Hills - including religious pilgrimage and ceremonies, personal prayer, camping, hunting, funerals, burial of the dead, Sun Dance, performing religious sacraments (including sweatlodges and vision questing) and other rites, use of water to grow fruits and vegetables for human consumption as well as plants and herbs for medicinal purposes and sacred narratives (including Origin legends, legends of culture heroes, and legends of the origins of ceremonies and sacred objects).

EPA does not agree that its actions would have an effect on these activities and uses of the water in the Black Hills outside the Project Area. Within the Project Area, the land is privately-owned and these activities and water uses could not occur without permission from the land owner. In addition, at the Project Site, the impacted areas of the Inyan aquifers are 200 to 900 feet below the surface and based on the permit conditions, contaminants are not projected to affect the groundwater beyond the horizontal extent of the aquifer exemption boundary. Surface impacts within the Project Area will be temporary and restored to pre-mining conditions after site decommissioning. EPA's action does not cause land impacts outside the Project Area. With respect to potential surface water impacts from injection activity, as discussed in Response #16, the Permittee must demonstrate adequate confining zones above and below the injection intervals and external mechanical integrity of injection, production and monitoring wells through the confining zones before EPA will issue authorization to inject. Therefore, no contaminants from injection activities will affect downgradient surface waters. The depth of the Minnelusa aquifer ranges between 1530 to 1840 feet at the Project Site and does not flow to ground level in this area. Thus, the groundwater affected by EPA's UIC permits will not impact surface water currently being utilized outside the Project Area for the activities described above; including for the growth of fruits, vegetables, herbs or other plants, or for ingestion by animals or for any present-day sweatlodge or other ceremonial activities occurring in the Black Hills. With respect to groundwater, any ceremonial activities that require 'pure' water or other uses described above, would not be utilizing the portions of the Inyan Kara and Minnelusa aquifers affected by EPA's action due to depth and water quality in these underground aquifers. The Minnelusa aquifer has high concentrations of total dissolved solids, sulfate, arsenic, selenium and strontium and the ore-bearing portions of the Inyan Kara aquifers have high radium, gross alpha and radon. (EPA Memorandum Documenting Inyan Kara and Minnelusa Aquifer Groundwater Quality).

### Cultural and Spiritual Interests

Tribal Nations and Tribal members voice a separate, but related, concern about water impacts – that regardless of whether the UIC activity is protective of underground sources of drinking water, as required by the SDWA – allowing injection of contaminants into the groundwater underlying a portion of the Black Hills is an affront to, and adversely impacts, Tribal cultural and spiritual interests in the sacred site. EPA has considered and acknowledges the impacts on Tribal spiritual and cultural interests in the Black Hills as a sacred site as described during EPA consultation discussions with Tribal governments and from comments received on this topic from Tribal governments, Tribal members and other interested parties during the public comment processes.

While acknowledging these interests, EPA's authorities to address potential impacts from its SDWA actions are specific to the protection of underground sources of drinking water. EPA may regulate to protect groundwater that supplies or can reasonably be expected to supply any public water system

from any contaminant that may be present as a result of underground injection activities. SDWA § 1421(d)(2); see also, 40 CFR § 144.12. The purpose of the UIC regulations is to prevent the movement of fluids containing contaminants into USDWs if the presence of those contaminants may cause a violation of a primary drinking water regulation or otherwise adversely affect human health. See 40 CFR §144.12(a). Within the scope of these SDWA authorities, EPA has considered the concerns raised by Tribal governments and other commenters regarding potential impacts of EPA's actions on the water quality of the Cheyenne River, the Madison aquifer specifically and on groundwater quality in general.

For example, in response to concerns raised by Tribal governments and other interested parties, and consistent with the goals of Executive Order 12898, EPA conducted additional analysis and incorporated conditions into the permit that are within the EPA's discretion to require. More specifically, in response to Tribal concerns and other comments received on the first draft Class V Area Permit, EPA conducted additional analysis of the confining zone between the Minnelusa injection zone and the Madison aquifer (which is the confining zone underlying the injection zone) and verified the presence of approximately 400 feet of low-permeability geologic units in the Lower Minnelusa Formation. In the exercise of EPA's UIC regulatory omnibus authorities under the SDWA, the Class V Area Permit requires Powertech to verify the presence of Minnelusa confining zones during the drilling of Madison water supply wells and requires characterization of the lower confining zone underlying the Minnelusa injection interval. These measures will help verify that overlying and underlying aquifers will not be impacted by injection zone fluids migrating across confining zones and into aquifers outside of the intended injection zone. In response to commenters' concerns that Powertech would inject waste fluids from other sites into the Class V wells, the Class V Area Permit limits injection fluids to waste fluids from the ISR process generated by the Dewey-Burdock Project: injection of waste fluids produced at any other sites is prohibited. Limiting the Class V injectate to only waste fluids generated at the Dewey-Burdock Project Site will help ensure the waste fluid volume is manageable, so injection rates are able to be maintained below permit limits. These permit requirements are in response to concerns raised by Tribal governments and other interested parties about potential adverse impacts to the Madison Formation aquifer.

EPA utilized its discretionary authority to require additional scrutiny of confining zones under the Class III Area Permit requirements to protect alluvial aquifers and prevent leakage from injection intervals to the surface. This additional scrutiny is in response to concerns from Tribes about impacts to the Cheyenne River expressed early in EPA's Tribal consultation process (note March 2013 web conference on impacts to the Cheyenne River in Table 1). The Class III Area Permit requires the Permittee to: 1) develop detailed wellfield cross sections showing thickness and continuity of confining zones through each wellfield; 2) identify known or suspected locations of exploration drillholes within the wellfield area and adapt the pump test design to detect evidence of inter-aquifer communication at drillhole locations; and 3) demonstrate external mechanical integrity testing of monitoring wells that penetrate confining zones to verify these wells do not create pathways for leachate to move out of the injection interval. The Permittee must plug and abandon and replace any monitoring well for which external mechanical integrity cannot be demonstrated.

UIC regulations allow ISR operations in areas where well pump test results indicate the presence of a breach in a confinement zone that the Permittee cannot precisely locate in order to perform corrective action or cannot eliminate through the application of best available technology, but requires operational controls and monitoring as the corrective action plan. The Class III Area Permit specifies that the

Director may require the Permittee to perform groundwater modeling or additional pump testing to demonstrate that the wellfield design and monitoring systems are sufficient to control and detect any potential excursions in this area before EPA authorizes injection into the wellfield. Under Part III Correction Action requirements, if a vertical excursion cannot be controlled in one of these breach areas during ISR operations because operational controls are not effective, the Class III Area Permit requires the Permittee to cease further injection activity in this location. The Permittee must remediate any vertical excursions that have occurred in this area. The Permittee must continue excursion monitoring in this area even though there is no longer any injection activity occurring.

The Class III Area Permit requires the Permittee to demonstrate in a Wellfield Closure Plan that no ISR contaminants will cross the aquifer exemption boundary and impact the Inyan Kara USDW. The Class III Area Permit also requires the Permittee to monitor for expanding excursion plumes and, under certain conditions, to develop a geochemical model to determine if a confirmed expanding excursion plume would result in ISR contaminants crossing the AE boundary. These requirements will prevent ISR contaminants from impacting downgradient users of Inyan Kara aquifers and downgradient areas where Inyan Kara aquifer may recharge the Cheyenne River. Finally, in the exercise of its omnibus authorities, the UIC permits require the permittee to submit to EPA, an Application for Construction Approval for the treatment and storage ponds under the Clean Air Act, 40 C.F.R. Part 61, Subparts A & W before EPA would issue an authorization to inject.

Thus, EPA has considered all relevant comments, including those asserting impacts to Tribal spiritual and cultural interests, in exercising its discretion within the scope of the Agency's SDWA UIC authorities to include permit conditions to protect against endangerment of the USDW with respect to all potentially-affected communities.

#### Additional Issues Raised

Potential adverse effects to historic properties related to the construction or operation of the UIC wells are addressed through the Agency's compliance with the National Historic Preservation Act [see Response #263 below]. EPA's response to comments raising concerns about treaty rights in the area are addressed in Responses #212 and 215 above and EPA's response to comments raising Native American Graves Protection and Repatriation Act concerns are addressed in Response #230 above.

**244. Protection of USDWs: commenters assert that the SDWA regulations directing EPA to ensure protection of USDWs and protection against adverse impacts to human health provide authority for the EPA to deny the UIC permits based on potential adverse impacts to Tribal spiritual and cultural interests in the Black Hills. While supporting the EPA's decision to acknowledge the cultural, spiritual ties the Lakota and other indigenous nations have to the Black Hills and the inclusion of the entire Black Hills in its EJ Analysis, one commenter asserts that adverse impacts to Tribal spiritual and cultural interests associated with any injection of contaminants also adversely impacts their health and thus comes within EPA's SDWA authority to protect human health.**

**Similarly, commenters assert that protection of USDWs should be interpreted broadly – to encompass not only protection of the USDW for drinking water purposes, but also for spiritual and cultural purposes and acknowledging the ties to Tribal treaty rights. The**

**commenter states that these values in water are all interwoven and cannot logically be separated to protect one use (drinking water) but not the other interests. One commenter expressed concern that EPA's proposed aquifer exemption decision considerations were too narrow because the decision was only based on human consumption and while it may be undrinkable to humans, it is not undrinkable to the earth, soil, plants or rivers.**

Response #244:

The SDWA and UIC regulations were promulgated to prevent endangerment to drinking water sources from underground injection. Accordingly, EPA's UIC authority is limited to the protection of underground sources of drinking water (USDWs). See 42 USC § 300h(b); 40 CFR §§ 144.3; 146.4. USDW is defined at 40 CFR § 144.3 and means:

An aquifer or its portion:

(a)(1) Which supplies any public water system; or

(2) Which contains a sufficient quantity of ground water to supply a public water system; and

(i) Currently supplies drinking water for human consumption; or

(ii) Contains fewer than 10,000 mg/l total dissolved solids; and

(b) Which is not an exempted aquifer.

We clarify that the UIC regulations protect USDWs from contamination, regardless of the use. In this case, EPA has determined that the permits are protective of USDWs; the mining area will be exempted from protection under the SDWA and will no longer be classified as a USDW, but the USDWs adjacent to the area will continue to be protected from endangerment.

The commenter refers to "protection against adverse impacts to human health" and asserts that SDWA provides EPA the authority to deny the permits based on potential impacts to tribal spiritual and cultural interests in the Black Hills. EPA disagrees with this statement. First, UIC permits can only be denied based on the criteria in the SDWA and its implementing regulations. Second, the commenter uses the phrase "protection against adverse impacts to human health" out of context. This concept is embodied in 40 CFR § 144.12(a) and is part of a standard of endangerment to USDWs. The standard of endangerment prohibits movement of fluid containing any contaminant into a USDW "if the presence of that contaminant may cause a violation of any primary drinking water regulation under 40 CFR part 142 [sic] or may otherwise adversely affect the health of persons."

In this case, EPA has determined that there will be no movement of fluid containing contaminants into a USDW based on the protective requirements in the UIC permits; therefore, the phrase referred to by the commenter is inapposite. If there is no movement of fluid containing contaminants into a USDW, there is no basis to deny the UIC permits because there would be no contaminants present that could cause a violation of a primary drinking water regulation or otherwise adversely affect the health of persons.

While the commenters do not articulate their concern in this way, it is possible that they do not agree that EPA's actions are protective because they do not agree that the mining area should be exempted from being a USDW under 40 CFR § 146.4. When promulgating a definition for USDW, EPA defined USDW broadly. However, EPA recognized this broad definition would result in classifying some aquifers

as USDWs even though they are contaminated, inaccessible, or otherwise unsuitable or unlikely to be used as drinking water. See 49 Fed. Reg. 20138, 20141 (May 11, 1984). Because of this, EPA included an exemption process in the UIC regulations to be able to review aquifers on a site-specific basis to determine whether an aquifer may be unsuitable as a drinking water source. See 40 CFR §§ 144.7, 146.4. This process is explained in detail in Response #94 above.

In this case, EPA's review found that the mining area within the Inyan Kara aquifer met the 40 CFR § 146.4 criteria for exemption and also does not have value as a drinking water source because of elevated levels of total dissolved solids, sulfate, iron, manganese, gross alpha, radium-226 and occasionally uranium. While commenters did not allege that the AE decision did not meet the criteria at 40 CFR § 146.4, they expressed that EPA's view was too narrow because it is only based on human consumption and while it may be undrinkable to humans, it is not undrinkable to the earth, soil, plants or rivers. EPA does not agree that these considerations warrant maintaining the USDW classification at this site. As explained throughout the RTC, the Class III Area Permit requirements prohibit ISR contaminants from crossing the aquifer exemption boundary or otherwise migrate to USDWs. Therefore, any contaminants from the AE area will not migrate to plants or rivers. Furthermore, the groundwater within the mining areas is required to be restored following mining and will continue to be available for all the uses the commenter describes.

EPA's response to comments raising concerns about treaty rights in the area are addressed in Responses #212 and 215.

**245. Consideration of Tribal Interests in the Black Hills: several commenters stated that the EPA acknowledges that the Lakota and other indigenous nations have important cultural, spiritual, and legal ties to the Black Hills, but then the Agency says it won't consider these issues in making its decisions. Commenters assert this is a clear violation of the requirement that these types of issues must be considered during the permitting process.**

Response #245:

EPA would like to clarify that it did not state that it would not consider the Tribal cultural, spiritual, legal and other interests in the Black Hills in making its decisions. On the contrary, EPA has considered and acknowledges the impacts on Tribal spiritual and cultural interests in the Black Hills as a sacred site as described during EPA consultation discussions with Tribal governments and from comments received on this topic from Tribal governments, Tribal members and other interested parties during the public comment processes. While recognizing these interests, however, EPA's authorities to address potential impacts from its SDWA actions are specific to the protection of underground sources of drinking water. EPA may regulate to protect groundwater that supplies or can reasonably be expected to supply any public water system from any contaminant that may be present as a result of underground injection activities. SDWA § 1421(d)(2); see also, 40 CFR § 144.12. The purpose of the UIC regulations is to prevent the movement of fluids containing contaminants into USDWs if the presence of those contaminants may cause a violation of a primary drinking water regulation or otherwise adversely affect human health. See, 40 CFR §144.12(a).

More specifically, EPA may regulate to protect groundwater that supplies or can reasonably be expected to supply any public water system from any contaminant that may be present as a result of underground

injection activities. SDWA § 1421(d)(2); see also, 40 CFR § 144.12. The purpose of the UIC regulations is to prevent the movement of fluids containing contaminants into USDWs if the presence of those contaminants may cause a violation of a primary drinking water regulation or otherwise adversely affect human health. See 40 CFR §144.12(a). Within the scope of these SDWA authorities, EPA has considered the concerns raised by Tribal governments and other commenters, including comments on impacts to their spiritual and cultural interests in the Black Hills. Please see Response #200 above for further information on how permit conditions reflect EPA’s consideration of input from Tribal governments and public participation in the permitting process.

**246. History of Uranium Mining in the Black Hills: commenters state that historical uranium mining in the Black Hills has led to elevated cancer rates, radioactive constituents in water and historic injustice for Tribal Nations and Tribal communities. Commenters describe the efforts of WARN, Owe Aku, the Black Hills Clean Water Alliance, Defenders of the Black Hills, and other Native and non-Native-led groups to mobilize an Environmental Justice movement in the Black Hills related to uranium mining and clean water. Commenters assert that the EPA’s EJ Analysis fails to acknowledge the history of local and regional EJ movements and their connection with the fight for treaty rights and state that their concerns with potential environmental harm from the proposed Dewey-Burdock project are grounded in and made more significant by past and ongoing experiences of contamination from historic uranium mining activities. One commenter states that the EJ Analysis fails to recognize that the communities who stand to be harmed by this project have experienced significant historic injustice when it comes to land and resource development and even examining only past uranium projects would lead to a more nuanced understanding of injustice in this region.**

Response #246:

EPA appreciates the information provided and has revised Section 9.4 of the EJ Analysis to address the connection between historic mining in the Black Hills and the Environmental Justice implications on the Tribes’ cultural and spiritual interest in the Black Hills.

**247. EPA Should Require Powertech to Plug All Historic Mining Boreholes and Reclaim Abandoned Mines in the Project Area: the commenter states that the EPA must require Powertech to properly plug all historic boreholes and reclaim historic abandoned mines in the project area before issuing any permits, and that failure to do so would allow a continued dangerous situation for impacted aquifers, rivers, reservoirs, and landowners.**

Response #247:

As discussed in Section 4.2.3 of the 2019 Fact Sheet for the draft Class III Area Permit, Part II of the Class III Area Permit requires the Permittee to take steps to identify leaky historic drillholes near the wellfield areas during the design and implementation of the wellfield pump tests (Section C), during the design of the wellfield monitoring system (Section D), during the implementation of formation testing (Section E), and during the implementation of the corrective action requirements in Part III. The Permittee must



complete these actions prior to receiving authorization to inject, to prevent these drillholes, or any other type of confining zone breach, from acting as pathways for contamination of USDWs. As discussed in Section 4.6 the 2019 Fact Sheet for the draft Class III Area Permit, the Permittee will not be able to begin injection activity until any breaches in injection interval confining zones are resolved. Corrective action allowed under the Class III Area Permit includes locating and plugging of improperly plugged historic exploration boreholes when they are able to be located. If there is a confining zone breach that cannot be located or physically corrected, UIC regulations and Class III Area Permit requirements also allow the Permittee to implement operational controls such as balancing flow and pressure in well patterns around a breach. If operational controls are used as the corrective action method, the Permittee must design and implement monitoring plan capable of demonstrating control of lixiviant in the areas where any breaches in the confining zone have been identified.

EPA is aware that the Atomic Safety and Licensing Board added a requirement to the NRC License requiring Powertech to attempt to locate and properly abandon all historic drill holes located within the perimeter well ring for the wellfield prior to conducting tests for a wellfield data package. [[Atomic Safety and Licensing Board, 2015, LBP-15-16](#) at 73]. However, the UIC regulations do not require this. This is discussed in Responses #13 and #14. EPA has determined that Powertech conducted an adequate investigation to identify improperly plugged historic exploration boreholes in the Class III Permit Application and provided documentation in the Class III Permit Application. Section 4.0 of the 2019 Fact Sheet for the draft Class III Area Permit discusses the Area of Review requirements Powertech had to meet in the Class III Permit Application. These investigations include an exploration drillhole inventory discussed in Section 4.2.3, an alluvial drilling program discussed in Section 4.3, evaluation of Chilson and Fall River potentiometric surface data discussed in Section 4.4 and a color-infrared (CIR) imagery analysis discussed in Section 4.5. The Class III Area Permit lists additional characterization requirements Powertech must conduct to identify improperly plugged historic exploration boreholes. However, EPA must issue the Class III Area Permit for these requirements to be enforceable.

EPA considered the abandoned uranium mines during evaluation of the area permit and does not anticipate cumulative effects in common with the Dewey Burdock project. Consideration of this issue can be found in the Fact Sheet for the draft Class III Area Permit Section 4.8. However, in order to verify this conclusion and ensure protection of adjacent USDWs, EPA included a requirement for monitoring well downgradient of the Triangle and Darrow pits to evaluate any impacts from the abandoned uranium mines during ISR operations. See Response #296 below.

### **General Comments on the Environmental Justice Analysis**

- 248. EPA's Definition of Environmental Justice as it Applies to this Action: one commenter quotes the EPA's definition of Environmental Justice (EJ), "the fair treatment and meaningful involvement of all people regardless of race, color, national origin, or income with respect to the development, implementation, and enforcement of environmental laws, regulations, and policies" and states that the fair treatment and meaningful involvement of Indian tribes requires doing more, including considering long-term impacts, destruction of historic sites, sacred sites, Native American gravesites, lost water resources and a continued policy of treating Indian communities as expendable populations. Another commenter states that although the draft EJ Analysis and the EPA's**

**actions seem to suggest an understanding that the project might affect Lakota and other tribal relationships with the Black Hills, the EJ Analysis does not acknowledge the possible burden the proposed project might place on the culture, religion, or health of Native peoples.**

Response #248:

EPA has prepared an extensive Environmental Justice (EJ) Analysis of the SDWA UIC permitting actions and associated aquifer exemption for the Dewey-Burdock Uranium ISR Project. The EJ Analysis recognizes that the area surrounding the Dewey-Burdock Project is of important religious, cultural, and spiritual significance to many Tribal Nations and Tribal members. For this reason, EPA has consulted extensively with Tribal governments on its SDWA actions. See Response #253 for a summary and table of EPA's Tribal consultation process.

EPA mailed NHPA consultation invitation letters in May of 2013 to 35 federally recognized Indian Tribes with a potential interest in EPA's then-proposed actions. EPA mailed tribal consultation invitation letters in November of 2015 to 38 Indian Tribes followed by three consultation meetings as web conferences, six meetings at Tribal government offices and one meeting in Denver. During Tribal consultation discussions, many Tribal government representatives described the important cultural, spiritual and religious significance of the area to Tribal governments and their members. In July 2019, EPA sent a Tribal consultation invitation follow-up letter to 38 Tribal Nations specifically inviting discussion on Tribal interests in the Black Hills as a sacred site and stating that EPA would welcome any input the Tribe would be willing to offer to assist EPA in presenting an accurate picture of Environmental Justice issues related to the Black Hills. After the 2019 letter was sent, the Region held meetings with the Cheyenne River Sioux Tribe, the Oglala Sioux Tribe, the Cheyenne and Arapaho Tribes, and two meetings with the Santee Sioux Nation.

In addition, EPA has considered comments received on this topic submitted by Tribal members and governments, as well as other interested stakeholders during the public comment processes on the permits. Tribal governments and commenters describe the cultural and spiritual significance of the Black Hills, as well as their historic and present-day activities and resource uses. The Agency has also reviewed published studies and analyses prepared by other federal agencies on the cultural significance of the Black Hills. The EJ Analysis has been revised to reflect the additional information received by the Agency.

Several Indian Tribes expressed concerns about potential impacts of In-Situ Uranium Recovery activities on the water quality of the Cheyenne River, the Madison aquifer specifically, and on groundwater quality in general. In response to Tribal concerns that the injection zone for the Class V deep injection wells lies above the Madison Formation aquifer, an important drinking water supply in western South Dakota, EPA conducted an analysis of the confining zone between the Minnelusa injection zone and the Madison aquifer (which is the confining zone underlying the injection zone) and verified the present of approximately 400 feet of low-permeability geologic units. The Class V Area Permit requires Powertech to verify the presence of this confining zone during the drilling of Madison water supply wells and requires characterization of the confining zone overlying the injection interval. These measures will help ensure that overlying aquifers will not be impacted by injection zone fluids migrating across confining zones and into aquifers outside of the intended injection zone. The Class III Area Permit requires characterization of the confining zone to help ensure that injection zone fluids will not flow upwards to the surface along breaches in confining zones and to minimize potential impacts to surface water. The

Class III Area Permit also requires the Permittee to demonstrate in a Wellfield Closure Plan that no ISR contaminants will cross the aquifer exemption boundary. These, and other, permit requirements are in response to concerns raised by Tribal governments and other interested parties, about potential adverse impacts to the Madison Formation aquifer. The Agency also prepared an extensive cumulative effects analysis that assesses potential groundwater, surface water and air impacts associated with EPA's actions.

Potential adverse effects to historic properties related to the construction or operation of the UIC wells are addressed through the Agency's compliance with the National Historic Preservation Act (see Response #263 below). EPA responses to comments raising Native American Graves Protection and Repatriation Act concerns and raising Religious Freedom Restoration Act concerns are addressed in Response #230.

**249. Social Dangers, Violence Towards Native American Women: the commenter states that the EPA should deny the mine permits due to the social dangers that accompany mining projects, and particularly the impacts to Native American women. The commenter asserts that societal impacts associated with mining operations lead to increased incidents of domestic violence and sexual assaults against women, and particularly Native American women on Indian Reservations, citing as an example, the increase in violent crime rates on the Fort Berthold Indian Reservation.**

Response #249:

EPA would like to clarify that it does not issue mining permits. The NRC has issued the license for the Dewey-Burdock project. EPA is aware that mining booms are associated with an increase in rates of violence towards Native American women in some locations. In this case, EPA does not agree that, by approving the UIC permits, there will be a significant change in the male/female ratio in the affected area or that there will be an increase in the rate of violence towards Native American women specifically. Factors considered include the current residents, demographics, and proximity to the nearest Indian Reservation (the Pine Ridge Indian Reservation is approximately 46 miles away), town centers and recreational areas close to the Reservation. According to NRC's SEIS, the size of both the construction workforce and the operation workforce for the Dewey-Burdock project will be small; 86 and 84, respectively, and the effects of ISR facility construction on demographic conditions, income, housing, employment rate, local finance, education, and health and social services, will be small. The NRC SEIS indicates that the operations workforce will be small in comparison to the combined labor force in Fall River, Custer, and Weston Counties. Social impacts from ISR facility construction and operation can be expected to be dispersed over a very large area and focused on multiple population centers and recreation areas (e.g. Edgemont, Custer, Hot Springs, Newcastle, Pine Ridge Casino, etc.). According to the U.S. Census Bureau's 2010 census data, the total male population within a 100-mile radius of the ISR facility is 132,866. The increase in male population due to ISR facility construction and operation is statistically insignificant when compared to this number. Also, according to the Census, Native American women make up approximately 3% of that area's population. Despite their increased vulnerability generally, since the population of Native American women in 100-mile radius of the project is relatively small, and due to the smaller workforce at the ISR facility, the potential for increased rates

of violence towards Native American women specifically, would be expected to be substantially less than expected impacts associated with a medium or large workforce influx.

**250. Table 12 – Federal and State permits: the commenter states that Table 12 of the EJ Analysis entitled “Additional State and Federal Permits Powertech is required to obtain” is misleading in its failure to include mention of the Clean Air Act permit that the EPA says is required; the current status of either the state water appropriation permits or the state Groundwater Discharge Plan which have been on hold for several years; and the NRC’s Source Material License.**

Response #250:

Table 9 of the EJ Analysis has been updated to reflect the current status of additional state and federal that Powertech is required to obtain. Specifically, the table now includes the date of the amended NRC License and the public comment period for BLM’s Plan of Operations. The table has also been updated to reflect that Powertech has not submitted to EPA, an Application for Construction Approval for the treatment and storage ponds under the Clean Air Act, 40 C.F.R. part 61, subparts A & W. The status of the Clean Air Act operating permit, the state water appropriation permits, the state Groundwater Discharge Plan, the Large Scale Mine Permit, and Application for Construction Approval of the treatment and storage ponds pursuant to 40 C.F.R. § 61.07 remain unchanged. In February 2013, South Dakota determined that a state-issued Air Quality operating air permit will not be required. South Dakota also stated that further hearings and process for the state water appropriation permits, the state Groundwater Discharge Plan, and the Large Scale Mine Permit would be postponed until the NRC and EPA have completed their actions. To our knowledge, the company has not submitted an application to the SDDENR for Clean Water Act National Pollutant Discharge Elimination System Water Discharge Permit (Stormwater Discharge) coverage nor has it applied to the U.S. Army Corps of Engineers for Clean Water Act Section 404 permit coverage.

**251. EPA’s Identification of Priority Permits for the Promotion of Meaningful Involvement of Overburdened Communities in Permitting Activities: one commenter states that UIC Class V and Class III permits should not be identified as priority permits for the promotion of meaningful involvement of overburdened communities due to the potential for significant public health or environmental impacts, in light of the lack of evidence of off-site impacts to non-exempt groundwater after decades of uranium ISR operations in the United States. The commenter requested an explanation of the source of EPA’s “potential for significant public health or environmental impacts” conclusion.**

Response #251:

EPA Region 8’s identification of priority permits for the promotion of meaningful involvement of overburdened communities in permitting activities is based on its 2013 *EPA Region 8 Regional Implementation Plan to Promote Meaningful Engagement of Overburdened Communities in Permitting Activities* ([EPA Region 8 2013 Implementation Plan](#)), which in turn, is based upon the document entitled

*EPA Activities To Promote Environmental Justice in the Permit Application Process*, 78 FR 27220 (May 9, 2013). This document states, “[t]o assist the regional offices in identifying priority permits for enhanced outreach, EPA has identified the types of permits that may involve activities with significant public health or environmental impacts. . . . Examples of permits that may involve activities with significant public health or environmental impacts can include, but are not limited to, the following: . . . Significant Underground Injection Control Program permits under the Safe Drinking Water Act.” *Id.* at 27223. EPA *Region 8 Implementation Plan* document further defines these priority permits to include, “Underground Injection Control (UIC) Program permits under the Safe Drinking Water Act (40 CFR parts 144 to 148) for Class I deep injection wells, large-scale Class II enhanced recovery (ER) project wells, Class III uranium in-situ recovery (ISR) wells or Class VI wells for Geologic Sequestration of CO<sub>2</sub>,” EPA *Region 8 Implementation Plan* also states, “[t]he region may become aware of potential EJ concerns for permit actions not considered significant and may decide to screen those permits on a case-by-case basis.”

Class III UIC permits for uranium ISR wells are specifically identified in the Region 8 Implementation Plan as priority permits that may involve activities with significant public health or environmental impacts. Although UIC permits for Class V injection wells are not specifically identified as high priority permits in EPA *Region 8 Implementation Plan*, EPA considers the Dewey-Burdock deep Class V injection wells to be as high a priority as the Class I deep injection wells specifically mentioned in the Plan. Because the injection zone for the deep Class V wells is above the Madison aquifer, an important source of drinking water in western South Dakota, EPA has included Class I well construction and monitoring requirements in the Class V Area Permit. Therefore, EPA considers both the Dewey Burdock Class III and Class V Area permits as a basis for automatically identifying these permit actions as appropriate for enhanced outreach under EPA *Region 8 Implementation Plan*.

**252. Changes to the UIC Class III Area Permit: the applicant provided several comments requesting changes to the UIC Class III Area Permit requirements as described in the EJ Analysis. The commenter requested that the EPA remove several requirements from the Class III Area Permit including: the wellfield closure plan; the conceptual site model and related sampling and analysis requirements; the geochemical model; and a number of monitoring requirements. These permit requirements involve evaluating the fate and transport of ISR contaminants and the demonstration that no ISR contaminants will cross the aquifer exemption boundary into the downgradient USDW after wellfield groundwater restoration is completed. The comments suggest the EPA should rely on NRC requirements to protect USDWs rather than include requirements in the Class III Area Permit that the commenter asserts are duplicative of and, in some cases are in addition to, NRC license requirements. The commenter requested that the EPA modify the EJ Analysis document to be consistent with these requested changes to the Class III Area Permit.**

Response #252:

EPA’s complete response to the applicant’s permit requirement changes can be found at Response #199 above. In summary, EPA did not make the requested changes to the EJ Analysis document because EPA did not modify the Class III Area Permit to remove the identified requirements and does not agree that it

is appropriate to rely on the NRC requirements for the protection of USDWs. The Class III UIC permit is being issued under the SDWA, which has specific regulatory requirements for in situ production of uranium and other minerals for the prevention of endangerment to USDWs from the injection activity. This includes specific requirements for modeling and monitoring provisions in a Class III permit. The UIC regulations do not allow for these modeling and monitoring requirements to be omitted or waived because another federal agency has its own requirements under a different statute. The modeling and monitoring provisions in the UIC permit are necessary to ensure that USDWs would be protected under the SDWA.

### **Comments on Environmental Justice Considerations in The Permitting Process**

- 253. Process: EPA Should Have Consulted with Tribal Governments Before Taking Action.**  
**Several commenters assert that EPA’s process of consulting with Tribal governments was insufficient and inconsistent with EPA’s trust relationship with federally-recognized tribes and with EPA’s consultation policies.**

Response #253:

EPA recognizes the importance of tribal consultation, and conducted extensive tribal consultation on the proposed Dewey-Burdock uranium in-situ recovery (ISR) site pursuant to the May 4, 2011 “EPA Policy on Consultation and Coordination with Indian Tribes” ([EPA Tribal Consultation Policy](#)) and the “EPA Policy on Consultation and Coordination with Indian Tribes: Guidance for Discussing Tribal Treaty Rights” ([EPA Treaty Rights Guidance](#)). Please also refer to Response #200.

Table 1 includes a summary of EPA’s tribal consultation and related efforts. EPA mailed NHPA consultation invitation letters in May of 2013 to 35 of the 38 Tribes listed in Table 2. EPA mailed a tribal consultation invitation letter in November of 2015 to 38 Tribes listed in Table 2. Following this 2015 letter, EPA held three consultation meetings as web conferences, six meetings at Tribal government offices and one meeting in Denver. EPA mailed another consultation invitation letter in July 2019 inviting consultation on treaty rights and on considerations of the Black Hills as a sacred site. EPA held four additional consultation meetings, three at Tribal government offices and one as a web conference.

EPA Region 8 leadership traveled to a number of locations to meet with Tribes, including the Oglala Sioux Tribe, the Standing Rock Sioux Tribe, the Cheyenne River Sioux Tribe, the Santee Sioux Nation, the Ponca Tribe of Nebraska, the Fort Belknap Tribes, the Northern Arapaho Tribe, the Crow Tribe, the Upper Sioux Community and the Cheyenne and Arapaho Tribes of Oklahoma. While not every Tribe considered these meetings to be government-to-government consultation, EPA conducted the meetings consistent with the *EPA Policy on Consultation and Coordination with Indian Tribes*. EPA treated every meeting with the appropriate protocols for a government-to-government consultation, including meeting attendance by EPA high level decision-makers; discussion of Tribal concerns expressed during the meetings; and subsequent written responses to the Tribes indicating EPA’s consideration of their concerns.

**Table 1. EPA Tribal Consultation and Related Events**

ACTIVITY	DATE	NOTES
<p>An EPA representative attended the Nuclear Regulatory Commission (NRC) Tribal consultation meeting for Dewey Burdock and Crow Butte in Rapid City with 13 tribes.</p>	<p>February 2012</p>	<p>Tribes requested EPA provide information on 4 topics:</p> <ol style="list-style-type: none"> <li>1. Cheyenne River Water Quality.</li> <li>2. Radiation Sources and Risks at uranium ISR sites.</li> <li>3. Geology &amp; Hydrology at the Dewey Burdock site and potential impacts from the ISR process.</li> <li>4. Seismology at the site.</li> </ol>
<p>EPA Web conference on Cheyenne River Water Quality. Presenters included:            Delinda Simmons, Water Quality Coordinator, Oglala Sioux Tribe            Carlyle Ducheneaux, Water Quality Specialist, Cheyenne River Sioux Tribe            Liz Rogers EPA Water Quality Lead for South Dakota            Peter Ismert, EPA Water Quality Lead for the Oglala Sioux Tribe            Tom Johnson, EPA Water Quality Lead for the Cheyenne River Sioux Tribe</p>	<p>March 2013</p>	<p>Fifteen tribes were invited:            Fort Peck Assiniboine and Sioux Tribes            Cheyenne River Sioux Tribe            Crow Creek Sioux Tribe            Crow Nation            Northern Arapaho Tribe            Flandreau Santee Sioux            Northern Cheyenne Nation            Oglala Sioux Tribe            Santee Sioux Nation            Sisseton Wahpeton Oyate            Standing Rock Sioux Tribe            Eastern Shoshone            Lower Brule Sioux Tribe            Rosebud Sioux Tribe            Yankton Sioux Tribe            Web conference included the Cheyenne River Sioux Tribe and other tribes. The audio file of the presentations was sent to the 15 tribes.</p>
<p>EPA Web Conference on Radiation Sources and Risks at uranium ISR sites presented at the Regional Tribal Operations Committee meeting.</p>	<p>April 2013</p>	<p>Region 8 Tribes were present at the meeting.</p>
<p>Sent invitation letters to leaders of 35 Tribal governments. Environmental Directors and Tribal Historic Preservation Officers were cc'ed.</p>	<p>Mailed and emailed letter            May 28-30, 2013</p>	<p>Invitation for NHPA Section 106 consultation and provided information on the June 10, 2013 informational web conference EPA committed to conducting. Information about</p>

		the first web conference was included in the letter.
EPA Web conference with the Cheyenne River Sioux Tribe and other tribes on Geology & Hydrology at the Dewey Burdock site and potential impacts from the ISR process.	June 2013	
EPA meeting with Oglala Sioux Tribe representatives in Hot Springs, SD.	June 11, 2015	EPA Regional Administrator requested a meeting with Oglala Sioux Tribal representatives.
EPA presentation at the Rocky Mountain Tribal Leaders Council Quarterly Meeting in Billings, MT. The Rocky Mountain Tribal Leaders Council serves the following tribes: The Blackfeet Nation The Chippewa Cree Tribe of Rock Boy's Indian Reservation The Confederated Salish and Kootenai Tribes The Crow Tribe The Eastern Shoshone Tribe The Fort Belknap Indian Community The Fort Peck Assiniboine and Sioux Tribes The Northern Arapaho Tribe The Northern Cheyenne Tribe The Little Shell Tribe of Chippewa Indians of Montana .	August 13, 2015	
EPA presentation at meeting with South Dakota, North Dakota and Montana Tribal Historic Preservation Officers in Bismarck, ND. Representatives from the following Tribes were present: The Cheyenne River Sioux The Crow Tribe The Flandreau Santee Sioux Tribe The Fort Belknap Tribes The Northern Cheyenne Tribe The Oglala Sioux Tribe	September 10, 2015	In conjunction with ND DOT meeting.



<p>The Rosebud Sioux Tribe  The Sisseton Wahpeton Oyate  The Spirit Lake Tribe  The Standing Rock Sioux Tribe  The Three Affiliated Tribes</p>		
<p>EPA presentation at meeting with Santee Sioux Nation and Ponca Tribes of Nebraska in Kansas City.</p>	<p>October 28, 2015</p>	
<p>EPA presentation at meeting with the Great Plains Tribal Chairman’s Association Meeting in Rapid City.  The Great Plains Tribal Chairman’s Association serves the following tribes:  The Cheyenne River Sioux  The Crow Creek Sioux Tribe  The Flandreau Santee Sioux Tribe  The Lower Brule Sioux Tribe  The Oglala Sioux Tribe  The Omaha Tribe  The Ponca Tribe of Nebraska  The Rosebud Sioux Tribe  The Santee Sioux Tribe  The Sisseton Wahpeton Oyate  The Spirit Lake Tribe  The Standing Rock Sioux Tribe  The Three Affiliated Tribes  The Turtle Mountain Band of Chippewa  The Winnebago Tribe  The Yankton Sioux Tribe</p>	<p>October 30, 2015</p>	
<p>EPA letters inviting tribal consultation meetings with 38 tribes, as well as NHPA section 106 consultation.</p>	<p>November 25, 2015</p>	
<p>EPA tribal consultation webinar with Environmental Director of Santee Sioux Nation.</p>	<p>February 19, 2016</p>	<p>Web conference</p>
<p>EPA tribal consultation webinar with Tribal Historic Preservation Officers (THPOs) from the Prairie Island Indian Community; Shakopee Mdewakanton Sioux</p>	<p>February 22, 2016</p>	<p>Web conference</p>

Community; and Upper Sioux Community.		
EPA tribal consultation meeting with the Crow Tribe in Billings, MT.	March 1, 2016	Meeting in person at the BIA Building
EPA tribal consultation meeting with the Northern Arapaho Tribe.	March 2, 2016	Conference call and webinar
EPA tribal consultation meeting with the Assiniboine and Gros Ventre Tribes of Fort Belknap in Billings, MT.	March 3, 2016	Meeting in person at the BIA Building
EPA tribal consultation meeting scheduled with the Cheyenne River Sioux Tribe.	March 8, 2016	Meeting was cancelled by Tribe on March 7
EPA tribal consultation web conference with Tribal Historic Preservation Officer of Standing Rock Sioux Tribe.	April 22, 2016	Provided background information on the Dewey-Burdock project
EPA tribal consultation meeting with the Oglala Sioux Tribe in Pine Ridge, SD.	April 28, 2016	In person meeting at the Oglala Sioux Justice Center
EPA tribal consultation meeting with the Standing Rock Sioux Tribe in Fort Yates, ND.	May 5, 2016	In person meeting at the Standing Rock Sioux Tribe Administration Building
EPA tribal consultation meeting with Oglala Sioux Tribal leaders in Denver, CO.	June 17, 2016	Presented community outreach plan. Tribal leaders requested that we present the plan to the Land and Natural Resources Committee
EPA presentation of EPA community outreach plan to Land and Natural Resources Committee of the Oglala Sioux Tribe.	July 18, 2016	In person meeting in Pine Ridge, SD
EPA letters inviting further tribal consultation meetings with 5 tribes on draft UIC permits, a draft Environmental Justice analysis and additional draft documents.	June 6, 2017	
EPA tribal consultation meeting with the Ponca Tribe of Nebraska in Lincoln, Nebraska.	August 23, 2017	In person meeting at the Ponca Tribe's Office in Lincoln, NE
EPA letters inviting further tribal consultation meetings with 38 tribes on revised draft UIC	July 8, 2019	

permits, a revised draft Environmental Justice analysis and additional revised draft documents, as well as NHPA section 106 consultation.		
EPA tribal consultation meeting with Cheyenne and Arapaho Tribes of Oklahoma in Concho, OK.	September 11, 2019	In person meeting in Concho, OK
EPA tribal consultation meeting with Cheyenne River Sioux Tribe in Eagle Butte, SD.	September 30, 2019	In person meeting in Eagle Butte, SD
EPA tribal consultation meeting with Santee Sioux Nation, Niobrara, NE.	November 20, 2019	In person meeting in Niobrara, NE
EPA letters to 15 tribes, following up on EPA's July 8, 2019 letter and reiterating its offer to hold further tribal consultation meetings.	February 14 and 21, 2020	The 15 Tribes included: The Cheyenne and Arapaho Tribes The Cheyenne River Sioux Tribe The Crow Tribe The Fort Belknap Tribes The Fort Peck Tribes The Northern Arapaho Tribe The Oglala Sioux Tribe The Ponca Tribe of Nebraska The Prairie Island Indian Community The Santee Sioux Tribe The Shakopee Mdewakanton Sioux Community The Standing Rock Sioux Tribe The Three Affiliated Tribes The Upper Sioux Community The Yankton Sioux Tribe
EPA tribal consultation meeting scheduled with the Oglala Sioux Tribe. The meeting did not occur.	March 23, 2020	EPA could not travel due to COVID-19-related travel restrictions and offered to conduct the meeting as a web conference.
EPA tribal consultation meeting scheduled with the Oglala Sioux Tribe. The meeting did not occur.	June 24, 2020	EPA could not travel due to COVID-19-related travel restrictions and offered to conduct the meeting as a web conference.

EPA tribal consultation meeting with Santee Sioux Nation, Web Conference.	July 20, 2020	
EPA tribal consultation meeting with the Sioux Tribe; virtual meeting	August 28, 2020	The Tribe stated that the meeting did not constitute tribal consultation under the Tribe's ordinance on government-to-government consultation.
Letter to Oglala Sioux Tribe to notify Tribe EPA's Tribal Consultation process has concluded.	October 21, 2020	
Letter to NRC, BLM, ACHP, SD SHPO, Powertech and 38 Tribes that EPA has adopted the NRC/BLM Programmatic Agreements	November 13, 2020	
Letters to 38 Tribes stating that the Tribal Consultation process is concluded and EPA has made its final UIC permit decisions.	November 24, 2020	The letter stated that concerns from Tribes that EPA heard during consultation are addressed in the Response to Comments (RTC) document enclosed with the letter. A link to the RTC was also included in the email.

**Table 2. List of Tribes Identified as Potential Consulting Parties.**

1	Assiniboine and Sioux Tribes of the Fort Peck Indian Reservation
2	Apache Tribe of Oklahoma
3	Arapaho Tribe of the Wind River Reservation
4	Blackfeet Tribe of Blackfeet Indian Reservation
5	Cheyenne and Arapaho Tribes Oklahoma
6	Cheyenne River Sioux Tribe of the Cheyenne River Reservation
7	Chippewa-Cree Tribe of Rocky Boy's Reservation
8	Confederated Salish and Kootenai Tribes of the Flathead Reservation
9	Crow Creek Sioux Tribe of the Crow Creek Reservation
10	Crow Tribe of the Montana
11	Eastern Shoshone Tribe of the Wind River Reservation
12	Flandreau Santee Sioux Tribe of South Dakota
13	Fort Belknap Indian Community of the Fort Belknap Reservation
14	Kiowa Indian Tribe of Oklahoma
15	Lower Brule Sioux Tribe of the Lower Brule Reservation
16	Lower Sioux Indian Community
17	Northern Cheyenne Tribe of the Northern Cheyenne Indian Reservation
18	Northwestern Band of the Shoshone Nation
19	Oglala Sioux Tribe
20	Omaha Tribe of Nebraska
21	Paiute Indian Tribe of Utah

22	Ponca Tribe of Indians of Oklahoma
23	Ponca Tribe of Nebraska
24	Prairie Island Indian Community
25	Rosebud Sioux Tribe of the Rosebud Indian Reservation
26	Santee Sioux Nation
27	Shakopee Mdewakanton Sioux Community
28	Sisseton-Wahpeton Oyate of The Lake Traverse Reservation
29	Skull Valley Band of Goshute Indians
30	Southern Ute Indian Tribe of the Southern Ute Reservation
31	Spirit Lake Tribe
32	Standing Rock Sioux Tribe
33	Three Affiliated Tribes of Fort Berthold Reservation
34	Turtle Mountain Band of Chippewa Indians
35	Upper Sioux Community
36	Ute Indian Tribe of the Uintah and Ouray Reservation
37	Ute Mountain Ute Tribe
38	Yankton Sioux Tribe

**254. Process: Tribal Consultation Should Have Been Concluded Before the Draft Permits Were Put Out for Comment: several commenters state that the draft permits should not have been issued for comment until proper and meaningful Tribal consultation had taken place in order to allow for sufficient consideration of Tribal interests. One commenter characterized EPA’s statement about SDWA authority being limited to protection of USDWs as complete dismissal of indigenous cultural and spiritual issues and failure to consider these issues is clear disdain of the National Historic Preservation Act, the environmental review process, and the many comments that EPA has received. The commenter stated that water is a spiritual issue, a cultural issue, and a treaty issue that cannot be considered separately and only under the context of legal authority. The comment further stated that the EPA’s approach is effectively saying it would ignore issues that are likely to be raised during consultation which is disingenuous and violates the spirit and the letter of the law.**

Response #254:

The Class III Permit Application was complete in January 2013. EPA sent the first letters to Tribes in May 2013 inviting consultation under NHPA Section 106. As shown in Table 1, EPA had already begun activities to engage Tribes and prepare for meaningful consultation. EPA sent a second round of letters to Tribes in November 2015 offering consultation under both NHPA Section 106 and EPA’s Policy on Consultation and Coordination with Indian Tribes. The first draft permits were not issued until March 2017. EPA offered and participated in Tribal consultation meetings prior to the issuance of draft permits in order to receive Tribal input and take these concerns into account during the development of the draft permits. The Tribes who shared concerns about impacts to historic properties and potential environmental impacts also provided input into the type of protective requirements they believed the

UIC permits should contain. EPA noted these concerns and took them into account in developing the draft permit requirements.

All of the Tribes with whom EPA consulted asked about the specific UIC permit requirements. EPA explained the requirements for protection of USDWs in UIC regulations and provided examples of what other UIC permits have required to address similar concerns. EPA committed to contacting the Tribes again after the draft UIC permits were issued and to provide opportunities to discuss the permit requirements.

EPA decided it was appropriate to issue draft permits and continue the Tribal consultation process in a meaningful manner so Tribes could review and provide input on the specific draft UIC permit requirements. Once the draft permits were issued in 2017 and the revised draft permits were issued in 2019, EPA continued its Tribal consultation efforts and discussions. During Tribal consultation discussions and separately during public comment periods on the initial draft and revised draft permits, Tribes provided comments which were considered by EPA and in some instances, resulted in changes to the final permits and other documents.

Please also refer to Responses #200 and #201 above.

Finally, EPA's explanation of SDWA authority for the protection of USDWs was not intended to be a dismissal of Tribal concerns about the spiritual and cultural importance of water and treaty rights Tribes may have to surface water and groundwater in the Black Hills. As stated above in Response # 245, EPA did not state that it would not consider the Tribal cultural, spiritual, legal and other interests in the Black Hills in making its decisions. On the contrary, EPA has considered and acknowledges the impacts on Tribal spiritual and cultural interests in the Black Hills as a sacred site as described during EPA consultation discussions with Tribal governments and from comments received on this topic from Tribal governments, Tribal members and other interested parties during the public comment processes.

**255. EPA Should Have Had a Translator at Public Hearings: several commenters stated that EPA should have had a translator at the public hearings in order to understand those speaking in their Native languages and as a matter of respect to commenters - particularly Tribal elders. Commenters stated that Native languages were spoken without interpretation, thus their voices would continue to be silenced unless they spoke in English.**

Response #255:

EPA's records show a request for a translator during the public hearings held in 2017. EPA did not prompt this type of request in its public outreach for these hearings nor did any member of the public request a translator prior to these hearings. In announcing its October 2019 hearing to the public, EPA similarly did not ask the public to request translation services for the hearing.

Based on EPA's review of its records, it appears that all commenters who spoke in their native languages also spoke in English, thus it is reasonable to believe that the comments they wanted to communicate to EPA were communicated in English. EPA also provided additional time after these hearings for commenters to submit written comments, which could have been submitted either in English or in the commenter's native language, if the commenter did not believe their verbal testimony was going to be

adequately recorded. EPA also acknowledges that while it could have asked in advance of its hearings whether translation support was needed, it would not have been reasonable to expect the agency to be prepared to translate any and all native languages spoken by one or more tribal members (including those from the 38 Tribal Nations with historic claims and/or interests in the Black Hills). In light of these considerations, EPA has determined that the absence of translation services during its public hearings did not prevent the comments intended for EPA consideration from being meaningfully communicated and considered during and after the public participation process.

**256. EPA Should Have Specifically Mentioned the EJ Analysis During the Public Hearings: one commenter states that although enhanced public participation was conducted during the EPA 2017 public hearings, this outreach focused almost completely on the potential health and water quality impacts of the project. In contrast, information from the draft Environmental Justice report was only mentioned, but not explained or referenced in any substantial manner by EPA officials. For that reason, the commenter questioned whether EPA conducted the Dewey-Burdock permitting process consistently with the EJ 2020 Action Agenda, which sets out four strategies for enhancing Environmental Justice towards Native peoples:**

- 1. Strengthen consideration of tribes' and indigenous peoples' issues, their involvement in EPA's decision-making processes, and responsiveness to their concerns when EPA directly implements federal environmental programs.**
- 2. Help federally recognized tribal governments build capacity and promote tribal action on environmental justice.**
- 3. Address disproportionate impacts, improve engagement, promote meaningful involvement, and improve responsiveness to the environmental justice concerns of indigenous peoples.**
- 4. Promote intergovernmental coordination and collaboration to address environmental justice concerns in Indian country and in areas of interest to tribes and indigenous peoples throughout the United States.**

**The commenter questions whether the UIC permitting process is consistent with these strategies and goals. The commenter states the 2017 outreach was almost completely on the potential health and water quality impacts of the project, while the EJ Analysis was only mentioned and not explained or referenced in any substantial manner by EPA officials.**

Response #256:

The technical presentation given by EPA during 2017 public hearings were focused on the type of technical and regulatory information that is not common knowledge for people without a geologic, hydrologic or regulatory knowledge base. The reason EPA presented this information was to provide the audience with technical background information for evaluating the permit requirements and the other draft documents EPA issued for public review and comment. During the presentation, EPA informed the

audience that there were other draft documents for the public to review and comment on, including the EJ Analysis, the Cumulative Effects Analysis and the NHPA document. EPA did not give a presentation at the 2019 public hearing.

EPA highlighted the 2019 draft EJ analysis in the July 2019 consultation invitation letters sent to 38 Tribes. In the letter, EPA specifically requested input from Tribes on Environmental Justice issues.

EPA offered and conducted Tribal consultation discussions as set forth in Responses #200 and #253 above. In addition, the public hearing processes were specifically tailored towards consideration of Tribal governments' and Tribal members' interests in EPA's action. For example, EPA held public hearings at Valentine, Nebraska, Rapid City, Hot Springs and Edgemont, South Dakota, to make attendance more easily accessible to the members of Sioux Tribes. EPA also offered to hold consultation meetings at locations easily accessible to Tribal leaders. EPA sent several letters to Tribal governments to keep them informed about the status of the UIC permitting and Tribal consultation processes. EPA also provided Tribes with written responses to the concerns expressed during consultation meetings and in written comments received from Tribes. At the request of the Tribes, EPA held informational web conferences about topics identified by the Tribes, including potential impacts to the Cheyenne River, site geology and hydrology, review of the permit application, and radiological impacts of the ISR project. EPA staff had phone calls and exchanged emails with Tribal government staff and Tribal members to answer questions and receive information. All of these efforts provided Tribal governments and Tribal members opportunities to engage in and impact EPA's decision-making process and demonstrated EPA's responsiveness to their concerns throughout the UIC decision-making process.

EPA concludes that the UIC permitting process was consistent with the strategies and goals of EJ2020.

#### **Additional Issues Raised by Comments on the Environmental Justice Analysis**

**257. Treaty Rights: many Tribal Nations and other interested parties commented on Tribal treaty rights and Article 6 of U.S. Constitution. Commenters assert that the Dewey-Burdock Uranium Mine site lies within several Tribes' 1851 territory and will have serious impacts on: (a) the Tribe's treaty rights and reserved water rights, (b) the Tribe's cultural resources; and (c) the Tribe's religious exercise.**

Response #257:

For comments asserting that the Dewey-Burdock Uranium Mine site lies within several Tribes' 1851 territory, please refer to Response #212 above. For comments asserting that the Dewey-Burdock Uranium Mine site will have serious impacts on Tribal treaty rights and reserved water rights, please refer to Responses #212 and #215 above. For comments asserting that the Dewey-Burdock Uranium Mine site will have serious impacts on Tribal cultural resources, please refer to Response #222 for comments concerning contamination of water affecting cultural resources, and please refer to Response #230 for comments concerning non-water contamination affecting cultural resources. For comments asserting that the Dewey-Burdock Uranium Mine site will have serious impacts on a Tribe's religious exercise, please refer to Response #230.



**258. Religious Freedom Restoration Act (RFRA): several commenters stated that EPA's action would interfere with Tribal religious practices in violation of the RFRA.**

Response #258:

Please refer to Response #230 above.

**259. United Nations Declaration of the Rights of Indigenous Peoples: several commenters state that the requirements of the United Nations Declaration of the Rights of Indigenous Peoples apply to the Dewey Burdock UIC permits and Article 29 paragraph 2 prohibits approval of the proposed permits without the consent of the Tribes, which has not been conferred. Thus, they assert that the EPA should fulfill its human rights responsibilities under the UN Declaration on the Rights of Indigenous Peoples and deny the mine permits.**

Response #259:

Please refer to Response #228 above.

**260. Archaeological Resources Protection Act (ARPA): several commenters stated that the Agency is required to consult with affected Tribes before archeological excavations on Tribal land as required by ARPA.**

Response #260:

Please refer to Response #234 above.

**261. Native American Graves Protection and Repatriation Act (NAGPRA): several commenters state that the EPA cannot desecrate of Native American gravesites and must comply with NAGPRA.**

Response #261:

Please refer to Response #230 above.

**262. National Historic Preservation Act (NHPA): many commenters state that the EPA must comply with the NHPA before approving the UIC permits and associated aquifer exemption. Commenters also assert that the EPA should not rely on the NRC's NHPA Section 106 process which they describe as inadequate. Several commenters state that the EJ Analysis mentions cultural resources, but they are not thoroughly analyzed.**

Response #262:

EPA's response to comments regarding NHPA compliance is at Response #263. The EJ Analysis describes and considers potential impacts to Tribal cultural and spiritual interests in the Black Hills as a sacred site.

## National Historic Preservation Act Comments

EPA sought comment on NHPA issues through the UIC program's public involvement procedures, which allow for public notice and comment on the draft UIC permit and its supporting record. See 36 C.F.R. §§ 800.2(d), 800.3(e); 40 CFR § 124.10. Specifically, EPA invited public comment on the identification of traditional cultural properties within the area of potential effects (APE) on the potential adverse effects of the proposed project, and on measures to avoid, minimize, or mitigate potential adverse effects on historic properties, including those of traditional religious and cultural importance, pursuant to 36 CFR § 800.2(d) and § 800.6(a)(4).

**263. The Agency received a number of comments related to compliance with the NHPA. Among them were general comments on the types of impacts and protected resources; specific comments about properties potentially covered by the NHPA; and comments characterizing the EPA's NHPA obligations and the Agency's fulfillment of them. The EPA also received comments on the NRC's NHPA compliance process, and on the EPA's potential reliance on the NRC's efforts.**

Response #263:

The approach to NHPA compliance that EPA has decided to follow in this matter makes a consolidated response to these comments appropriate.

### *Agency Public Involvement Responsibilities Under the NHPA*

Under the applicable implementing regulations, federal agency compliance with section 106 of the NHPA includes providing for appropriate public involvement. This involvement may occur, as it did here, through the public involvement procedures of another program that the federal agency is implementing. 36 C.F.R. §§ 800.2(d). The agency must "seek and consider the views of the public in a manner that reflects the nature and complexity of the undertaking and its effects on historic properties, the likely interest of the public in the effects on historic properties, confidentiality concerns of private individuals and businesses, and the relationship of the Federal involvement to the undertaking." *Id.*<sup>11</sup>

### *Lead Agency Designation*

The Dewey-Burdock Project is an undertaking, as defined at 36 C.F.R. § 800.16(y), in that it is a project requiring federal permits, licenses, and approvals, including EPA UIC permits and aquifer exemption as well as the NRC license. In the case of an undertaking involving actions by one or more federal agencies, such as the Dewey-Burdock project, the ACHP's regulations provide that some or all of the agencies involved "may designate a lead federal agency," whose section 106 compliance fulfills the collective section 106 responsibilities of the other federal agencies. 36 C.F.R. § 800.2(a)(2). In this matter, involved federal agencies may designate the NRC as the lead agency, and may rely on the NRC's NHPA

---

<sup>11</sup> See also Section 106 Regulations Section-by-Section Questions and Answers, Advisory Council on Historic Preservation (ACHP), <https://www.achp.gov/digital-library-section-106-landing/section-106-regulations-section-section-questions-and-answers> (agency must give the public the opportunity "to examine the results of the agency's effort to identify historic properties, evaluate their significance, and assess the undertaking's effects upon them," and "to express their views on resolving adverse effects") (accessed October 5, 2020).

compliance in accordance with stipulation 7 of the Programmatic Agreement (PA) developed by the NRC and other parties:

**Coordination with Other Federal Reviews:**

Any federal agency that will provide approvals or assistance for the undertaking as presently proposed may comply with its Section 106 responsibilities for the undertaking by agreeing to the terms of this PA in writing and sending copies of such written agreement to all the signatories and consulting parties of this PA. Such agreement to the terms of this PA will not necessitate an amendment to the PA.

Programmatic Agreement Among U.S. Nuclear Regulatory Commission, U.S. Bureau of Land Management, South Dakota State Historic Preservation Office, Powertech (USA), Inc., and Advisory Council on Historic Preservation Regarding the Dewey-Burdock In Situ Recovery Project Located in Custer and Fall River Counties, South Dakota (<https://www.nrc.gov/docs/ML1406/ML14066A347.pdf>). The PA was developed “to take into account the effects of the [Dewey-Burdock Project] undertaking on historic properties.” PA at 4.

*Previous EPA Statements Regarding NHPA Compliance*

EPA’s anticipated approach to compliance with section 106 was discussed in the Draft Compliance and Review Document for the Proposed Dewey-Burdock In-Situ Uranium Recovery Project (August 2019), which was included as a part of the docket for the draft EPA Underground Injection Control permits for the facility. In the draft Compliance and Review Document, EPA documented several determinations relevant to compliance with section 106:

- EPA’s federal UIC permitting for the Project is a federal undertaking. 36 CFR §§ 800.3, 800.16(y).
- This undertaking has the potential to cause effects on historic properties. 36 CFR § 800.3(a).
- The Site is in South Dakota, and is not on tribal lands as defined at 36 CFR § 800.16(x).
- The Area of Potential Effect (APE) consists of 3,887 acres within the 10,580-acre Dewey-Burdock Project Area described in Section 2.1 of the Fact Sheet for the UIC draft Class III Area Permit.

The draft Compliance and Review Document also noted that EPA was coordinating its NHPA review efforts with other required federal reviews, consistent with 36 CFR § 800.3(b), and summarized EPA’s efforts to that point to consult with the South Dakota State Historic Preservation Office (SHPO), 38 federally recognized tribes, the NRC, and the BLM.

EPA further stated in the draft Compliance and Review Document that the agency was considering whether to rely on the NRC’s section 106 review and consultation, which could be accomplished by adopting the NRC PA, or whether to complete a separate section 106 process.

*EPA Final NHPA Section 106 Compliance Determination*

After considering public comments and other available information in the record, EPA has determined that relying on the NRC’s section 106 review and consultation will appropriately address EPA’s NHPA compliance obligations for this project. Having a single agency serve as the lead, with input from other

agencies as appropriate, promotes efficiency in government. According to the ACHP, “[s]ignificant advantages to designating a single lead federal agency for Section 106 review can include increased efficiency in coordinating and communicating with consulting parties, less duplicative analyses and paperwork, and more clarity and consistency in reaching findings and determinations.” Frequently Asked Questions About Lead Federal Agencies in Section 106 Review, available at <https://www.achp.gov/digital-library-section-106-landing/frequently-asked-questions-about-lead-federal-agencies> (accessed Oct. 6, 2020). Further, EPA has concluded that completing a separate, parallel NHPA compliance effort would not meaningfully alter the protection of historic properties in connection with this undertaking. Accordingly, EPA has signed the PA and provided that signature to the other parties in accordance with PA stipulation 7. (See EPA November 13, 2020 Letter to the Advisory Council on Historic Preservation in the administrative record.)

Appendix B of the PA includes information on archaeological and tribal field surveys, and describes cultural resources identified within and adjacent to the boundary of the 10,580-acre project site. More than 300 cultural resources were identified based on this evaluation. Under the PA, Powertech is also required to protect all unevaluated properties until a determination is made as to their eligibility for inclusion on the National Register of Historic Places, and additional investigations are required if changes in the project design could affect any unevaluated properties. PA at 5 (stipulation 3.a., 3.b.). The PA also includes provisions for halting ground-disturbing work and evaluating any previously unknown cultural resources discovered during implementation of the project. PA at 10 (stipulation 9).

As a signatory to the PA, EPA will have certain specified ongoing roles and responsibilities, including:

- Reviewing draft treatment plans and revised draft treatment plans for addressing adverse effects on historic properties.
- Review and comment on Powertech’s draft Monitoring Plan for monitoring during the project to ensure that PA requirements are met.
- Review and comment on annual Monitoring Plan reports.
- Participate in calls discussing PA implementation.
- Participate in dispute resolution if that is invoked.
- Review, comment, and agree on amendments to PA.

Participating in these ways will help ensure that the PA functions effectively to protect historic properties. In addition, EPA will support the NRC in its role as lead agency as appropriate by providing information and recommendations in connection with areas of the project where EPA has knowledge or expertise.

#### *EPA Responses to NHPA Issues Raised in Comments*

As a general matter, EPA’s responsibilities under section 106 are being addressed in accordance with the Programmatic Agreement, which was developed by the NRC and other signatory agencies, and which EPA has now signed. EPA’s signature on the PA is sufficient to establish the Agency’s compliance with the NHPA. See PA at 10 (stipulation 7); 36 C.F.R. §§ 800.2(a)(2), 800.14(B). Accordingly, EPA has no further NHPA compliance obligations in connection with the Dewey-Burdock project, although as noted we will participate in accordance with our role as a signatory to the PA. Also, consistent with the NRC’s

role as lead agency, and with our role as a signatory to the PA, EPA will forward to the NRC all comments relevant to the identification of historic properties or to impacts upon them.

EPA's decision to rely on NRC as the lead federal agency for NHPA compliance is a matter committed to agency discretion by the relevant regulations. See 36 C.F.R. § 800.2(a)(2) ("If more than one Federal agency is involved in an undertaking, some or all the agencies may designate a lead Federal agency."). And comments directed to the sufficiency of the NRC's section 106 compliance process are beyond the scope of this action. We note, however, that – contrary to the assertions of some commenters – the NRC's NHPA process has been upheld in response to administrative petitions, while the D.C. Circuit declined to consider the petitioners' challenge to the NHPA process. See *In re Powertech USA, Inc.*, 86 N.R.C. 167 (Oct. 19, 2017), *pet. for rev. denied*, 88 NRC 1 (2018) (granting summary disposition of administrative challenge on NHPA grounds); see also *In re Powertech (USA) Inc.*, 90 N.R.C. 287, 287 (Dec. 12, 2019), *pet. for rev. pending* (finding in favor of NRC staff on "sole remaining contention," related to National Environmental Policy Act (NEPA)); *In re Powertech USA, Inc.*, Memorandum and Order, NRC Docket No. 40-9075-MLA (Oct. 8, 2020) (finding that renewed challenges concerning NHPA were brought impermissibly late, and that NRC staff had satisfied NEPA responsibilities; affirming ASLB's December 12, 2019 decision); *Oglala Sioux Tribe v. U.S. Nuclear Regulatory Comm'n*, 896 F.3d 520, 527 n.4 (D.C. Cir. 2018) (noting that NHPA issues were not before the court). The NRC's administrative review process is complete. EPA has concluded that the interests of efficiency in government and historic and cultural resource protection are best served by designating NRC as the lead agency in accordance with the provisions of the PA.

### **National Environmental Policy Act**

**264. EPA received comments regarding EPA's compliance with the National Environmental Policy Act (NEPA) and EPA's compliance with NEPA's implementing regulations. EPA also received comments regarding statutory and regulatory exemptions for EPA compliance with NEPA. In addition, EPA received comments regarding the applicability of the doctrine of NEPA functional equivalency to EPA, the legal basis for the NEPA functional equivalence doctrine, and EPA's compliance with the NEPA functional equivalence doctrine. EPA also received comments regarding the Nuclear Regulatory Commission (NRC)'s NEPA analysis.**

Response #264:

EPA Compliance with NEPA and the NEPA Functional Equivalence Doctrine

EPA determined that its action on Powertech's applications for Class III and Class V Underground Injection Control (UIC) permits and the aquifer exemption pursuant to SDWA is exempt from NEPA consistent with EPA's longstanding view, as well as the U.S. Court of Appeals for the 8<sup>th</sup> Circuit's decision in *Western Nebraska Resources Council v. U.S. E.P.A.*, 943 F.2d 867 (8<sup>th</sup> Cir. 1991) and other relevant NEPA case law. EPA did not need to conduct a formal NEPA analysis prior to making its SDWA decisions on Powertech's applications for the UIC permits and aquifer exemption. October 23, 2020 Memo from Sarah Bahrman, Chief, Drinking Water Branch, EPA Region 8 to the File.

Ordinarily, federal agencies must prepare an Environmental Impact Statement (EIS) for, *inter alia*, “major Federal Actions significantly affecting the quality of the human environment...” NEPA § 102(C), 42 U.S.C. § 4332(C). However, certain statutes administered by EPA contain explicit exemptions from compliance with NEPA. See Section 511(c) of the Clean Water Act (CWA), exempting most EPA actions under the Clean Water Act from NEPA’s requirements, and Section 7(c) of the Energy Supply and Environmental Coordination Act of 1974 (15 U.S.C. 793(c)(1)), exempting all EPA actions under the Clean Air Act from the requirements of NEPA. Pursuant to those statutory exemptions, EPA need not undertake compliance with NEPA when undertaking certain actions.

In addition, courts have exempted certain EPA actions from the procedural requirements of NEPA through the “functional equivalence” doctrine. See 72 Fed. Reg. 53652, 53654 (Sept. 19, 2007). Under this doctrine, the courts have found EPA to be exempt from the procedural requirements of NEPA for certain actions under multiple statutes, including SDWA. *Id.* The courts reasoned that EPA actions under these statutes are functionally equivalent to the analysis required under NEPA because they are undertaken with full consideration of environmental impacts and opportunities for public involvement. *Id.*

The U.S. Court of Appeals for the 8<sup>th</sup> Circuit found the SDWA is the functional equivalent of NEPA and therefore formal NEPA compliance is not required by EPA when the Agency takes action pursuant to the SDWA. *Western Nebraska Resources Council v. U.S. E.P.A.*, 943 F.2d 867 (8<sup>th</sup> Cir. 1991) (finding that a formal NEPA analysis was not required for issuance of an aquifer exemption under the SDWA by EPA Region 7 because the SDWA and EPA’s aquifer exemption issuance in that case were the functional equivalent of NEPA).<sup>12</sup> The court agreed with “the many circuits that have held that EPA does not need to comply with the formal requirements of NEPA in performing its environmental protection functions under ‘organic legislation [that] mandates specific procedures for considering the environment that are functional equivalents of the impact statement process.’” *Id.* at 871-872 (quoting and citing *State of Ala. ex rel. Siegelman*, 911 F.2d 499, 504 (11<sup>th</sup> Cir. 1990) and cases cited therein). The 8<sup>th</sup> Circuit “further agree[d] that [the] SDWA is such legislation, and that the procedures employed and the analysis undertaken by EPA in this proceeding covered the core NEPA concerns.” *Id.* at 872. Therefore, EPA’s alleged non-compliance with NEPA did not provide a basis for the court to reverse the Agency approval of the aquifer exemption. *Id.*<sup>13</sup>

In addition to EPA actions under the SDWA constituting the functional equivalence of NEPA in accordance with the court’s decision in *Western Nebraska* and the NEPA functional equivalence doctrine, EPA consolidated permitting regulations at 40 CFR § 124.9(b)(6) promulgated in 1980 specifically exempt certain EPA permitting actions, including the issuance of UIC permits, from NEPA:

“... NPDES permits other than permits to new sources as well as all RCRA, UIC and PSD permits are not subject to the environmental impact statement provisions of section

---

<sup>12</sup> The Dewey Burdock project site is located in South Dakota. The U.S. Court of Appeals for the 8<sup>th</sup> Circuit has jurisdiction over South Dakota.

<sup>13</sup> In addition, EPA’s longstanding view is that regulatory actions taken under SDWA are exempt from NEPA’s EIS requirements. See 44 Fed. Reg. 64174 (Nov. 6, 1979).

102(2)(C) of the National Environmental Policy Act, 42 U.S.C. 4321.” 40 C.F.R. § 124.9(b)(6) (emphasis added).

In promulgating this regulation, EPA noted in the preamble to the final rule that “[w]hen these regulations were proposed, the preamble stated EPA’s position that [NEPA] does not require preparation of an [EIS] when permits are issued under the RCRA, UIC, or PSD programs, or when non-new source NPDES permits are issued... No comments opposing this position were received, and a number of comments supported it, either directly or by necessary implication. Accordingly, the same position has been adopted in the final regulations.” 45 Fed. Reg. 33290, 33406 (May 19, 1980) (internal citations omitted).

EPA’s Environmental Appeals Board (EAB or Board) has upheld the application of this regulatory exemption from NEPA to permitting actions in various contexts. *See e.g., In re IT Corp.* 1 E.A.D. 777, 1983 WL 192060 at \*1-2 (1983) (Resource Conservation and Recovery Act (RCRA)); *In re Chemical Waste Management, Inc.* 2 E.A.D. 575, 1988 WL 236329 at \*2 (1988) (RCRA); *In re U.S. Pollution Control, Inc.*, 3 E.A.D. 799, 1992 WL 82627 at \*1 (1992) (RCRA); *In re Knauf Fiber Glass, GMBH*, 8 E.A.D. 121, 171, 1999 WL 64235 at \*35 (1999) (Clean Air Act (CAA) citing 40 C.F.R. § 124.9(b)(6) re: prevention of significant deterioration (PSD) permit and noting CAA statutory exemption); *In re Am. Soda, LLP*, 9 E.A.D. 280, 290-292, 2000 WL 893129 at \*8-9 (2000) (SDWA) *In re Beeland Group, LLC*, 14 E.A.D. 189, 205-206, 2008 WL 4517160 at \*13-14 (2008) (SDWA); *In re Windfall Oil and Gas, Inc.* 16 E.A.D. 769, 811, 2015 WL 3782844 at \*30 (2015) (SDWA).

The EAB first addressed 40 C.F.R. § 124.9(b)(6) in the SDWA UIC permitting context in *In re Am. Soda, LLP*, 9 E.A.D. 280, 290-292, 2000 WL 893129 at \*8-9 (2000). In a challenge to EPA Region 8’s issuance of a SDWA UIC Class III area permit, the EAB analyzed EPA’s NEPA obligations and the functional equivalence doctrine. “Notwithstanding NEPA’s general application to major federal actions, courts have long recognized that NEPA’s primary goal is to require government to consider the environmental consequences of its decision...[and] courts have developed the doctrine of ‘functional equivalency’ to ensure that NEPA remains consistent with its primary goal and does not add one more regulatory hurdle to the process.” *In re American Soda* at 290.

The Board described the functional equivalency test as providing that “where a federal agency is engaged primarily in an examination of environmental questions, and where substantive and procedural standards ensure full and adequate consideration of environmental issues, then formal NEPA compliance with NEPA is not necessary, [and] functional compliance [is]... sufficient.” *In re Am. Soda* at 290-291 *citing Warren County v. North Carolina*, 528 F. Supp. 276, 286 (E.D.N.C. 1981).

The Board also noted that in *In re IT Corporation*, 1 E.A.D. 777 (Adm’r 1982) (RCRA), “the Administrator observed, ‘[T]he courts have recognized that Federal regulatory action taken by an agency with recognized environmental expertise, when circumscribed by extensive procedures, including public participation for evaluation of environmental issues, constitutes the functional equivalent of NEPA’s requirements’” *In re Am. Soda* at 291 (citing *In re IT Corporation* at 778). The EAB further noted that the Administrator held in *In re IT Corporation* that 40 C.F.R. § 124.9(b)(6) codified the caselaw on NEPA functional equivalence and that the RCRA permitting program was the functional equivalent of NEPA. *Id.*

Ultimately, the EAB found that 40 C.F.R. § 124.9(b)(6) was dispositive of the question of the UIC permit program's functional equivalence to NEPA and under the plain language of the provision, Region 8 was not required to prepare an EIS in support of the UIC permit at issue in that case. *In re Am. Soda* at 291-292.

Similarly, in the context of an appeal of an EPA Region 5 permit authorizing construction and injection of a UIC Class I well, the EAB found that the "Part 124 permitting regulations codify the functional equivalence doctrine and exempt UIC permit actions from NEPA's environmental impact statement requirement" and held that 40 C.F.R. § 124.9(b)(6) is "dispositive on the question of the UIC permit program's functional equivalence to NEPA[,] and an environmental impact statement is not required for UIC permit issuance." *In re Beeland Group, LLC*, 14 E.A.D. 189, 205-206, 2008 WL 4517160 at (2008) (citing *In re Am. Soda*). *Accord, In re Windfall Oil and Gas, Inc.* 16 E.A.D. 769, 811, 2015 WL 3782844 at \*30 (2015) (citing *In re Am. Soda* in context of UIC permit authorizing construction of a UIC Class II well).

#### NEPA Functional Equivalence of EPA's Decision on UIC Permits

EPA's actions regarding Powertech's applications for SDWA Class III and Class V UIC permits are exempt from NEPA pursuant to 40 C.F.R. § 124.9(b)(6) as well as the functional equivalence doctrine and relevant caselaw, and therefore EPA did not need to complete a formal NEPA analysis prior to action on the UIC permits. In addition, in this instance, EPA conducted an extensive public process, including tribal consultation, regarding the proposed aquifer exemption and considered the environmental impacts of the UIC permits.

#### NEPA Functional Equivalence of EPA's Decision Regarding Aquifer Exemption

As discussed above, the U.S. Court of Appeals for the 8<sup>th</sup> Circuit, in the context of an EPA approval of an aquifer exemption, found that the SDWA is the functional equivalent of NEPA and therefore formal NEPA compliance is not required by EPA when the Agency takes action pursuant to the SDWA. *Western Nebraska Resources Council v. U.S. E.P.A.*, 943 F.2d 867 (8<sup>th</sup> Cir. 1991) (finding that a formal NEPA analysis was not required for issuance of an aquifer exemption under the SDWA by EPA Region 7 because the SDWA and EPA's aquifer exemption issuance in that case were the functional equivalent of NEPA).

EPA's action regarding Powertech's application for an aquifer exemption is therefore exempt from NEPA compliance under EPA's longstanding view, the NEPA functional equivalence doctrine and relevant caselaw. In addition, in this instance, EPA conducted an extensive public process, including tribal consultation, regarding the proposed aquifer exemption and considered the environmental impacts of the exemption. EPA therefore need not conduct a formal NEPA analysis prior to action on the aquifer exemption at issue here.

#### NRC NEPA Analysis

NRC conducted its own analysis to comply with NEPA. Comments regarding the NRC's NEPA documents should be directed to NRC and review of the adequacy of NRC's NEPA compliance is appropriately left to NRC and its administrative process. EPA considered NRC NEPA documents as well as many other



resources as part of EPA's SDWA decision-making process regarding the UIC permits and the aquifer exemption. As discussed above, EPA's actions regarding Powertech's applications for SDWA Class III and Class V UIC permits as well as the aquifer exemption are exempt from NEPA pursuant to 40 C.F.R. § 124.9(b)(6) as well as the functional equivalence doctrine and relevant caselaw.

### **Cumulative Effects Analysis**

#### **265. Comments submitted by Powertech: C3 through C92**

Response #265:

Any Powertech comments that are not addressed below are addressed in the Appendix.

#### **266. Two commenters raised security concerns related to the transportation of uranium. One commenter further stated that EPA must provide extra scrutiny to the packaging and transport of these wastes because other NRC-licensed ISL projects have sent unspecified liquid radioactive wastes in leaking trucks.**

Response #266:

EPA evaluated NRC's assessment of transportation impacts, including, transportation accidents and spills in Sections 5.5 (Overview of types of Transportation Accidents), 5.5.1 through 5.5.4 (describing impacts of each type of spill, such as yellowcake shipments, process chemicals and fuel, byproduct material, etc.), 13.1.1 (accidents involving yellowcake shipments), 13.1.2 (accidents involving resin-hauling trucks), 13.2 (other types of potential accidents) of the CEA and found them to be acceptable. As described in these CEA sections, Powertech will comply with guidelines and regulations of the U.S. NRC and U.S. DOT, as well as the South Dakota Department of Natural Resources and South Dakota Department of Transportation, to ensure the safe transport of hazardous materials. See e.g., SEIS Section 4.3.1.1.2. Further, the NRC's analysis considered previous accidents involving yellowcake releases that resulted in up to 30 percent of shipment contents being released and took into consideration Powertech's proposed measures to limit the risk of such accidents during transportation. Such measures include Powertech's proposal to transport all such materials in accordance with U.S. DOT and NRC regulations, such as handling them as low specific-activity materials, and shipping them with exclusive-use-only vehicles. NRC concluded that the consequences of such accidents would also be limited due to Powertech's proposal to develop emergency response procedures that its personnel and carriers will receive training on, should any transportation accidents occur during shipment to or from the proposed Dewey-Burdock ISR Project. Powertech also plans to provide these procedures to state and local agencies. SEIS Section 4.3.1.1.2, at 4-18.

Beyond analysis of impacts related to potential leaks and spills, it is not clear what commenters meant in referencing "security concerns" related to the transportation of uranium. If the commenters intended to reference the potential for criminal activity against trucks transporting uranium, these issues are outside the scope of the cumulative effects analysis required under 40 CFR § 144.33. It is not reasonable to expand the scope of this analysis to include purely speculative and hypothetical activity unrelated to the effects of the ISR uranium project.

**267. A commenter stated that the CEA did not specify the treatment of radioactive wastes from the drying cycle at the Central Processing Plant. The commenter referred to the statement in the CEA that “off-gases generated during the drying cycle will be filtered through a baghouse” (p. 86), and it also mentions a “sock filter” (p. 87). The commenter asserted that: “the CEA does not provide any information on where or how the wastes in the filters/baghouse would be disposed. It is assumed that these wastes will be radioactive, so should probably be 11e wastes. But readers (and the company) should not have to guess about such things.” The commenter asserted that the treatment of radioactive wastes should be the subject of comprehensive analysis, and that such an analysis should clearly explain the entire waste cycle. The commenter also noted that the Draft does not discuss potential accidents during processing (which have occurred), or the remediation or mitigation that might be needed as a result.**

Response #267:

The commenter misunderstands the discussions in Sections 9.0 and 9.4 on baghouse and sock filters described in the Cumulative Effects Analysis (CEA). These sections are not about radioactive waste but rather about how radionuclide particulates will be controlled.

EPA would direct the commenter to sections 3.3.4 through 3.3.4.2 for discussions on how radioactive wastes are dealt with on-site. These sections discuss Powertech’s proposed construction of ponds to treat and store the liquid waste fluids generated by ISR operations that will be injected into the Class V deep disposal wells or land applied under a Groundwater Discharge Permit (GDP). These ponds will contain water treated to below radioactive and hazardous waste limits. Sections 15.4 through 15.4.4 discuss the Class V deep well injection and land application disposal options related to solid and liquid byproduct materials. EPA disagrees with commenter’s assertion that the treatment of radioactive wastes and the radioactive waste cycle should be the subject of comprehensive analysis in the CEA, as some of these activities are outside the scope of the analysis required in 40 CFR § 144.33. EPA’s discussion of cumulative effects of radioactive waste is limited to those environmental effects at or near the project site that occur close in time with the drilling and operation of the injection wells. It does not include activities further in time or too far away from the project site.

EPA addressed potential accidents that could occur during uranium processing, and the remediation or mitigation that might be needed as a result in sections 5.3 and 13.2 of the CEA. Section 5.3 describes how the Central Processing and Satellite Facilities have the greatest likelihood of potential accidents or spills because it is the hub for production operations at the project, and also describes protective measures in place given these heightened risks. Section 13.2 describes additional potential accidents that have occurred in other ISR facilities, and measures that the NRC license and the proposed DENR Large Scale Mine permit also require Powertech to implement to prevent or mitigate system failures, that could potentially result in exceeding exposure limits.

**268. Powertech asserts that in the first sentence in this section, the statement is made that NRC evaluated the impacts of transporting “yellowcake slurry.” According to Powertech, slurry is an intermediate product in the yellowcake production cycle that is dried to produce the final yellowcake product, and notes that this is described in Section 3.2.3.1 of the NRC Safety Evaluation Report (SER): “The [Central Processing Plant] will also contain 2 vacuum dryers for drying yellowcake slurry into its final powder form” (Exhibit 014 at p.**

**96). Powertech requests removing the word “slurry” since yellowcake slurry will not be shipped from the Dewey-Burdock Project site.**

Response #268:

EPA agrees that “yellowcake slurry” as referred to in Section 13.1 (“Transportation Accidents”) should be “dried yellowcake,” as stated in Section 3.2.3.1 of the NRC Safety Evaluation Report (SER). EPA has updated the first sentence of Section 13.1 accordingly. EPA has reviewed the description of the yellowcake production process in the license application report and confirmed that there will be no yellowcake slurry transportation on-site.

**269. A commenter raised concerns with the proposal under the land-application disposal option to fence the area where contaminated water will be applied to keep out livestock and people. The commenter expressed the following specific concern: “how will you assure that deer and pronghorn do not enter this area and consume grass with high levels of arsenic and radioactive elements, which can then enter the human food chain via hunting and consumption of these animals?”**

Response #269:

The commenter misunderstands EPA’s role with regard to land application disposal. EPA does not have authority under the Safe Drinking Water Act (SDWA) to include permitting requirements for land application. Our only role under the SDWA is to consider this issue to determine whether effects related to the drilling and operation of additional injection wells are acceptable. See 40 CFR § 144.33(c)(3). As described in the CEA, requirements surrounding the land application disposal method are under the purview of the South Dakota DENR and a groundwater discharge permit, and not within EPA’s UIC permitting authorities. In Section 8.5 of the Groundwater Discharge Permit application, Powertech committed to working with affected landowners to prevent grazing on land application areas during land application and mentioned fencing as a mitigation measure. For more detail see: [https://denr.sd.gov/des/gw/Powertech/Powertech\\_GW\\_Discharge\\_Permit.aspx](https://denr.sd.gov/des/gw/Powertech/Powertech_GW_Discharge_Permit.aspx) (last visited October 9, 2020).

As for the commenter’s concerns related to entry of certain animals such as deer and pronghorn into the human food chain through hunting and/or other consumption, EPA has disclosed the potential for impacts and mitigation measures to the extent possible based on requirements under the NRC license and the proposed SD GDP as described in the CEA. The land application areas, including the ponds, will be fenced in to prevent access. Based on EPA’s review of this information, we determined these effects to be acceptable.

**270. A commenter asserted that while Section 10.1 Overview of Operations of the Class III permit states that Powertech may use land application in conjunction with deep disposal wells or by itself as waste disposal options, the Administrative Record does not analyze the potential for combined disposal methods (deep well and land application), or the potential for onsite disposal of wastes produced off site.**

Response #270:

The commenter is referring to Section 10.1, Overview of Operations of Powertech's Class III Permit Application. EPA disagrees with the commenter because the CEA does discuss the potential for combined disposal methods (deep well and land application) in several sections, including Sections 4.7 (Impacts from Deep Injection Well and Land Application Disposal Options for Treated ISR Waste Fluids) and 15.5.4 (Disposal Via Combination of Class V Injection and Land Application). Section 15.5.4 describes how the land application facilities and infrastructure will be constructed, operated, restored, and decommissioned on an as-needed basis depending on the deep injection well disposal capacity. Therefore, only a portion of land application facilities and infrastructure (e.g., irrigation areas and storage ponds) will be constructed, operated, and decommissioned for the combined disposal option. Further, the CEA documents EPA's review of potential impacts to a variety of receptors associated with the Dewey-Burdock Project based on these two disposal options. Where appropriate, the document evaluates the cumulative impacts of injection and land disposal of treated ISR waste fluids, e.g., as they relate to impacts on surface waters and wetlands (in Section 4.0) and soils (in Section 7.0). EPA also evaluated the impacts of waste management activities at the site (in Section 15).

Further, as explained in the CEA, Powertech will only use the land application disposal method of treated ISR waste fluid disposal if the Class V Area Permit cannot be used or if the deep disposal wells cannot accommodate the volume of the treated ISR waste fluids produced by the Dewey-Burdock ISR project.

Finally, there is no need to analyze onsite disposal of waste produced off-site, as this is not allowed under the Class V Area Permit. Part IV, Section K.1 of the Class V Area Permit specifies that injection fluid is limited to waste fluids from the ISR process generated by the Dewey-Burdock Project.

**271. A commenter stated that EPA should also include a detailed analysis of the plan for disposal of radioactive and toxic waste that will be generated as part of the water treatment at the site.**

Response #271:

EPA disagrees with the commenter's implication that the CEA did not include a detailed analysis of the disposal plan for radioactive waste generated as part of water treatment at the site. This is described in Sections 3.3.4 and 15.0 of the CEA. EPA cannot more specifically respond to this comment, as the comment does not include adequate detail about why the analyses in these sections are inadequate. Please see Response #330 below for further explanation of why EPA did not consider permanent disposal of solid byproduct waste taken off-site in its CEA analysis.

**272. One commenter asserted that the likelihood of land application would be greater in comparison to waste disposal by means of injection of treated ISR waste fluid and that accordingly, Powertech's application does not address the cumulative impacts of land application of toxic waste fluid including selenium. The commenter adds that selenium is highly toxic to people and wildlife, and that a full and complete analysis of these impacts is needed. Another commenter stated that plant and vegetative forage root systems will**

**take up any contaminants in soil solution from the land application of treated ISR waste fluids and contaminants can migrate through soil to shallow groundwater or nearby surface water, further increasing wildlife's exposure to harmful constituents. A commenter referred to Powertech's December 8, 2016 statement regarding concerns that removing the Deadwood Formation as an option for injection of treated ISR waste fluids would greatly diminish the capacity for waste fluid disposal, and then Powertech's subsequent withdrawal of its request to inject in the Deadwood Formation.**

Response #272:

EPA's CEA addressed the issue of cumulative effects of land application. EPA agrees that it is important to monitor impacts to soil and groundwater from land application of treated ISR waste fluid, including the potential for metals such as selenium, to accumulate in the soils and vegetation. As described in Section 7.3 of the CEA, Powertech's proposed land application operations will have to meet applicable state standards for the protection of the environment including groundwater, soils, vegetation, biota, and wildlife, in accordance with the proposed DENR Groundwater Discharge Permit (GDP). GDP application Table 5.8-2 provides estimates of metals concentrations expected to be in the treated ISR waste fluids that will be land applied. Powertech anticipates that metal concentrations will be at or below human health standards set by South Dakota's water quality regulations. Selenium concentration is expected to be less than 0.2 mg/L. Powertech acknowledges the potential for buildup of metals over time in the land application areas. Powertech has committed to mitigating potential impacts by monitoring soil concentrations during operations and implementing a contingency plan if soil concentrations approach trigger values. Table 8.3-1 lists the proposed trigger value for selenium in surface and subsurface soil as the baseline average concentration plus two standard deviations. DENR will conduct monitoring and associated regulatory oversight (including issuing enforcement actions or requiring corrective actions) for the duration of the project, which will help to limit potential short-term and long-term impacts to soils.

EPA disagrees that removing the Deadwood Formation injection zone increases the likelihood that land application will be necessary for the disposal of treated ISR process waste fluids. As described in a previous response, it is unlikely that the land application disposal method will be needed due to a lack of capacity of the deep disposal wells method. See Section 15.5.4 of the CEA. The final Class V Area Permit allows the Permittee to construct up to four injection wells completed in the Minnelusa Formation injection zone if additional injection capacity is required.

**273. Powertech requests clarification of the following statement made in the CEA: "During groundwater restoration, contaminated water is pumped from the wellfield injection interval, treated with reverse osmosis, and most of the clean permeate from the reverse osmosis treatment process is reinjected." Powertech requests clarification in the CEA that reverse osmosis would only be used in the deep disposal well option.**

Response #273:

EPA agrees with the commenter that reverse osmosis would only be used in the deep disposal well option, and that further clarification is needed regarding the sentence that the commenter refers to in the CEA (Section 3.1.1 and the "Inyan Kara Aquifers"). At the point in the document where the

statement appears, the two disposal options for waste fluids had not been discussed. Thus, EPA agrees that some explanation needs to be added in the CEA and has added the following to replace the sentence that the commenter refers to in Section 3.1.1:

During groundwater restoration, the amount of Inyan Kara groundwater that is recirculated, as opposed to withdrawn and not returned to the aquifer, depends on the waste fluid disposal method. If waste fluids are injected into the Class V injection wells for disposal, contaminated groundwater pumped from the wellfield injection interval during groundwater restoration will be treated with reverse osmosis. The clean permeate from the reverse osmosis treatment process will be reinjected. If Powertech is not able to use the Class V injection well option for the disposal of waste fluids, then the water that is withdrawn from the wellfield injection interval during groundwater restoration will not be returned to the aquifer.

**274. Powertech raised two comments that referred to the following statement in the CEA: “Powertech estimates the maximum volume of liquid wastes injected into the deep injection wells during aquifer restoration will be 155 gpm (see Section 3.1.1 of this document).” According to Powertech, the reference to Section 3.1.1 is for estimated Inyan Kara water consumption during concurrent operations and aquifer restoration, rather than the maximum injection volume. Powertech further explains that the correct maximum volume of liquid waste injection during concurrent operations and aquifer restoration is 232 gpm, as stated on page 144 (3rd paragraph) of this document. Powertech asserts that this amount is consistent with Figure 7.1 of the Class III permit application and Table 5.3-2 of the proposed Large Scale Mine Permit. Powertech states that the word “volume” should be replaced with “flowrate” in this same sentence. Therefore, Powertech requests correcting this statement as follows:**

**Powertech estimates the maximum ~~volume~~-flowrate of liquid wastes injected into the deep injection wells during aquifer restoration will be 232 ~~155~~ gpm (see Section 15.3.1-1 of this document).**

Response #274:

EPA agrees with Powertech’s comment that the correct maximum volume of liquid waste here should be 232 gpm, and that the cross-reference needs to be updated to Section 15.3.1. EPA also agrees that "flowrate" is the appropriate term rather than "volume." EPA has made the corresponding changes in the CEA.

**275. Powertech states that in the first paragraph in this section, the statement is made that “Powertech estimates that typical liquid waste flow rates during groundwater sweep under the land application option during aquifer restoration will be approximately 507 gpm as shown in Table 5, Section 3.1.2 of this document.” Powertech states that similar to the last comment, the reference to Section 3.1.2 is for estimated Madison usage, not wastewater disposal requirements under the land application option. Powertech explains**

that Figure 7.1 of the Class III permit application and Table 5.3-2 of the Large Scale Mine Permit Application show that the maximum anticipated liquid waste flow rate during concurrent operations and aquifer restoration under the land application option is 582 gpm. Powertech requests correcting this statement as follows:

**Powertech estimates that typical liquid waste flow rates during groundwater sweep under the land application option during aquifer restoration will be approximately 582 507 gpm as described shown in Table 5, Section 15.3.1.2 of this document.**

Response #275:

EPA agrees with Powertech's proposed changes in this comment and has made edits in the CEA as Powertech proposes in this comment. The 582 gpm flow rate is derived by adding up the waste stream flows from Figure 7.1 of the Class III permit application. The 582 gpm flow rate is the total of Burdock Liquid Waste (Stream ID I) during the uranium recovery phase for the land application disposal option (54 gpm), plus Burdock Liquid Waste (Stream ID I) for the Restoration phase, with Groundwater Sweep, land application disposal option (250 gpm) outlined in green in the Figure S below, plus Dewey Liquid Waste (Stream ID N) during the uranium recovery phase for the land application disposal option (28 gpm), plus Dewey Liquid Waste (Stream ID N) for the Restoration phase, with Groundwater Sweep, land application disposal option (250 gpm) outlined in blue in the Figure S below. Those numbers add up to 582 gpm.

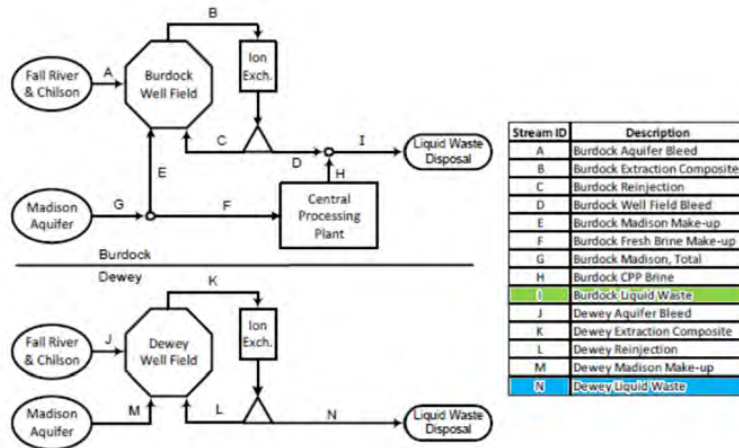

Water Balance Flow Rates (gpm)				Burdock							
Operation Phase	Aquifer Bleed Option	Disposal Option	Stream ID								
			A	B	C	D	E	F	G	H	I
Recovery	0.875%	DDW	42	4800	4758	42	0	12	12	12	54
		LA	42	4800	4758	42	0	12	12	12	54
Restoration	Without Groundwater Sweep	DDW	2.5	250	175	75	73	0	73	0	75
		LA	2.5	250	0	250	247.5	0	247.5	0	250
	With Groundwater Sweep	DDW	42	250	175	75	33	0	33	0	75
		LA	42	250	0	250	208	0	208	0	250

Water Balance Flow Rates (gpm)				Dewey				
Operation Phase	Aquifer Bleed Option	Disposal Option	Stream ID					
			J	K	L	M	N	
Recovery	0.875%	DDW	28	3200	3172	0	28	
		LA	28	3200	3172	0	28	
Restoration	Without Groundwater Sweep	DDW	2.5	250	175	73	75	
		LA	2.5	250	0	247.5	250	
	With Groundwater Sweep	DDW	42	250	175	33	75	
		LA	42	250	0	208	250	

Figure S. Anticipated Project-Wide Flow Rates during Uranium Recovery and Groundwater Restoration

276. Powertech states that in the first paragraph, the statement is made that the maximum liquid byproduct material quantity requiring disposal in the deep well injection option will be 197 gpm. Powertech notes that “as described in comment #C35 and as correctly listed in the 3rd paragraph in this section, the correct maximum volume of liquid waste injection during concurrent operations and aquifer restoration is 232 gpm.” Powertech requests correcting the maximum liquid waste generation rate in the deep disposal well option from “197 gpm” to “232 gpm.”

Response #276:

EPA agrees with Powertech’s comment that the correct maximum volume of liquid waste here should be 232 gpm and has made the corresponding change in the CEA.

277. Powertech raises a comment regarding the following statement: “Powertech proposed the construction of two Minnelusa injection wells, DW No. 1 in the Burdock Area and DW No. 3 in the Dewey Area.” According to Powertech, this statement does not



**appear to be consistent with the Class V permit application or Draft Class V Area Permit, both of which discuss up to four Minnelusa injection wells. Powertech requests updating the discussion to account for the four Class V injection wells included in the Class V Area Permit.**

Response #277:

EPA agrees that additional clarification is needed in the CEA so that there is consistency with the Class V area permit (on p.7) and its discussion of Minnelusa injection wells. The Class V permit says that “up to four injection wells for Minnelusa formation only” may be constructed. Accordingly, EPA replaced the statement that Powertech refers to in this comment with the following sentence: “Powertech has proposed the construction of one Minnelusa well in the Burdock Area; however, the Class V Area Permit allows the construction of up to four Minnelusa wells if required for disposal of the volume of waste fluids produced at the site.”

**278. Powertech asserts that the CEA makes the statement that the maximum production of liquid byproduct material in the land application option will be 547 gpm. Powertech asserts that as described in another comment, (comment #C36), the correct maximum volume of liquid waste injection during concurrent operations and aquifer restoration is 582 gpm. Powertech requests correcting the maximum liquid waste generation rate in the land application option from “547 gpm” to “582 gpm.”**

Response #278:

EPA agrees with Powertech’s proposed revision and has changed the maximum liquid waste generation rate reference in Section 15.3.2 from 547 gpm to 582 gpm. Powertech proposed a higher flow rate in the UIC Class III permit application than they had proposed in their NRC License application. Therefore, EPA agrees it is appropriate to replace 547 gpm in Section 15.3.2 with 582 gpm, consistent with Powertech’s Class III permit application.

**279. Powertech requests clarifying that the 66 cubic yards of solid byproduct material is an annual estimate during operations, and that this comment also applies to Section 15.4.4.**

Response #279:

EPA agrees with Powertech’s comment that clarification is needed and has added “annually” after “66 cubic yards” in both Sections 15.3.4 and 15.4.4 of the CEA where the reference to the annual estimated solid byproduct material is made.

**280. Powertech raised a comment regarding the following sentence: “Powertech proposes to manage aquifer restoration wastewater (i.e., liquid byproduct material) by treating the wastewater by reverse osmosis and reinjecting the treated water (i.e., permeate) back into the aquifer production zone undergoing restoration as described in**

SEIS Section 2.1.1.1.4.1” (emphasis added). Powertech requests clarification that the water withdrawn from the wellfields during groundwater restoration is not wastewater; it is treated by reverse osmosis (in the deep disposal well option), and the resulting reject is treated and disposed as wastewater. According to Powertech, the water withdrawn from the wellfield and the treated water (permeate), while still considered 11e.(2) byproduct materials under NRC regulation, are not wastewater. Powertech requests modifying this sentence as follows:

**Powertech proposes to manage water pumped from the ISR wellfields during aquifer restoration ~~wastewater~~ (i.e., liquid byproduct material) by treating the ~~wastewater~~ by reverse osmosis and reinjecting the treated water (i.e., permeate) back into the aquifer production zone undergoing restoration as described in SEIS Section 2.1.1.1.4.1.**

Response #280:

EPA agrees with the commenter that clarification is needed and updated the CEA with the commenter’s proposed edits.

**281. Powertech states that in the eleventh line in this section, the statement is made that “The NRC, the DENR and EPA will require liquid byproduct material be treated prior to injection and treatment systems be approved, constructed, operated, and monitored to ensure release standards ... are met.” Powertech is not aware that EPA has any permit requirements for the land application of treated wastewater and requests clarification on this statement or removal of EPA from the list of agencies authorizing land application.**

Response #281:

EPA believes that the CEA statement that the commenter refers to mistakenly referred to “injection” in “injection and treatment systems.” Rather, EPA’s intent was to refer to “land application and treatment systems” rather than “injection.” EPA agrees with the commenter that EPA should be removed from the list of agencies authorizing land application. EPA has updated the CEA accordingly to replace the sentence that the commenter refers to in Section 15.4.2 with the following: “The NRC and the DENR will require liquid byproduct material be treated prior to land application and treatment systems be approved, constructed, operated, and monitored to ensure release standards in 10 CFR Part 20, Subparts D and K and Appendix B are met.”

**282. Powertech requests explanation of the reference for the statement that “The NRC will update this evaluation as part of the pre-operational analysis for the Dewey-Burdock Project Site, and certify that binding contractual arrangements and commitments for providing capacity for the proposed Dewey-Burdock ISR Project have been made with one or both of these landfill options prior to beginning construction.”**

Response #282:

EPA agrees that the statement that the commenter refers to is incorrect and the CEA needs to be updated. EPA had misinterpreted the extent of the NRC's pre-operational analysis, which does not extend to the disposal of solid waste that is not by-product material. Therefore, this statement has been deleted in the final CEA document.

**283. Powertech raises a comment regarding the following statement: "Powertech will be required to have an agreement in place with White Mesa Mill for the disposal of solid by-product waste." Powertech asserts that although White Mesa Mill has been identified as the preferred location for disposal of solid byproduct material, the NRC license does not require an agreement with any particular 11e.(2) byproduct material disposal facility. According to Powertech, the requirements in NRC License Conditions 12.6 and 9.9, as stated on page 150 of this document, require Powertech to submit to the NRC a disposal agreement with a licensed disposal site before beginning operations and to maintain an agreement throughout operations. Powertech requests revising this sentence as follows:**

**Before the NRC will authorize commencement of ISR operations, Powertech will be required to have an agreement in place with a facility that is licensed by the NRC or an NRC Agreement State to receive byproduct material, such as the White Mesa Mill ~~for the disposal of solid by-product waste.~~**

Response #283:

EPA incorrectly stated in Section 15.6 of the CEA document that Powertech will be required to have an agreement in place with White Mesa Mill for the disposal of solid by-product waste. While, NRC License requirement 9.9 states "The licensee shall dispose of solid byproduct material from the Dewey-Burdock Project at a site that is licensed by the NRC or an NRC Agreement State to receive byproduct material," it does not specify a particular licensed facility. EPA updated the statement in CEA Section 15.6 to be consistent with this requirement.

**284. A commenter stated that the Draft Cumulative Effects Analysis was difficult to read because the Draft neither had a Table of Contents nor an Index.**

Response #284:

EPA included a Table of Contents in the final CEA.

**285. Several commenters asserted that the CEA should consider cumulative impacts of additional mines that are adjacent or near the proposed mine site. Some commenters discussed the potential for uranium mining to expand onto Powertech/Azarga's contiguous claims on the Wyoming side of the state line (the Dewey Terrace uranium project), as well as Powertech's claims to the east of the current project boundary.**

**According to the commenters' research, the company has approximately 744 federal claims in Wyoming, with the majority being across the border from the Dewey-Burdock project area. Commenters also recommended that the cumulative impacts of two neighboring uranium projects—particularly on water—be fully considered if both the Dewey-Burdock project and the Dewey Terrace project are approved, because it would result in the impact on the Minnelusa aquifer and other groundwater and surface water resources being doubled. The commenter asserted that these adjacent projects both threaten the water resources of the Black Hills, a region that straddles the state line, and that because both South Dakota and Wyoming are within Region 8, EPA is in a position to consider and evaluate these adjacent uranium projects in conjunction with each other.**

Response #285:

The commenters do not specify which two neighboring uranium projects they are referring to. The closest uranium projects to the Dewey Burdock site are: Crow Butte, 65 miles away; Strata Ross, 88 miles away; and Smith Ranch, 88 miles away. These projects are far away and do not have cumulative environmental impacts in common with the Dewey Burdock site.

With regard to the potential uranium development to the east and west of the Dewey Burdock project, consideration of these future projects is outside the scope of the cumulative effects analysis required by the UIC regulations at 40 CFR § 144.33(c)(3), as they are merely speculative. Should Powertech wish to expand its project in the future, EPA may need to modify the current area permit (if the projects are under our program and not a state's program), re-evaluate the cumulative effects on the environment under this permit, or both. If modifications to the Dewey Burdock area permits are necessary due to an expansion, they would be subject to a public participation process in accordance with 40 CFR part 124.

**286. A commenter noted that the need for assessment of the nearby uranium mines is even greater for the Class V draft permit, which might allow wastes from other mines to be injected into ground water in the Dewey-Burdock area.**

Response #286:

Response #285 above discusses EPA's consideration of nearby uranium mines. In addition, the commenter's concern about other mine waste being injected at Dewey Burdock has been addressed because the Class V Area Permit limits injection fluid to waste fluids from the ISR process generated by the Dewey-Burdock Project.

**287. A commenter stated that sedimentation ponds from the ISR mining operation will leak and contaminate ground water (which they have in other ISR locations), that migratory birds will land in these ponds, insects will obtain water from them to become food for birds, and West Nile virus will become more prevalent because of the breeding opportunities for mosquitoes among other things.**

Response #287:

EPA considered these issues and addressed them. The commenter does not identify any specific concerns with EPA's approach. As the CEA explains in Section 3.3.4.2, the requirements of Clean Air Act subpart W may apply to the structures at the proposed Dewey-Burdock uranium recovery facility that are used to contain the uranium by-product material. Subpart W requirements would apply to impoundments or ponds where uranium byproduct material is stored or treated, including those storing treated uranium byproduct material prior to either land application or deep well injection. Section 3.3.4.2 explains that EPA's concerns regarding potential leaks from ponds would be addressed by ensuring that the impoundments or ponds would meet pond construction requirements under subpart W. Therefore, EPA imposed a permit condition in each of the UIC area permits, which states that authorization to inject will not be issued until Powertech submits information about the ponds and EPA makes an applicability determination under subpart W; if subpart W requirements are applicable, the permit condition requires Powertech to receive the necessary construction approvals. Subpart W requires ponds to be constructed in accordance with 40 CFR § 264.221. Section 264.221(c) requires ponds to comply with stipulated lining requirements, installation of a leak detection system, and a leachate collection and removal system between such liners. Sections 264.221(g) and (h) require a surface impoundment to be designed, constructed, maintained, and operated to prevent overtopping resulting from normal or abnormal operations and other causes, and the massive failure of the dikes. EPA's conclusion remains unchanged that impacts to groundwater and surface water impacts will be acceptable with the inclusion of this permit condition.

As for the commenter's assertion that sedimentation ponds have leaked and contaminated groundwater in other ISR locations, the commenter provides no specific information for EPA to consider. Additionally, what has occurred at other ISR locations based on other operators' noncompliance is not relevant to this project site.

Finally, the commenter's concerns about further attenuated impacts on migratory birds and the insects it eats, etc., are both too speculative and too remote in time to be included within the scope of the analysis. However, EPA notes that the UIC permit includes measures to mitigate potential adverse impacts to federally-listed species for purposes of compliance with the Endangered Species Act. An example of such a mitigation measure is the UIC permit condition that requires Powertech to install netting, and to use bird balls or other acceptable bird deterrent method to prevent birds and bats from accessing the ponds. While this permit requirement is intended to protect the federally-listed species, it will have the incidental benefit of similarly deterring other migratory birds or bats from accessing the ponds.

**288. Some commenters recommended that the various types of ponds should not be built where there are old drill holes. The commenter also recommended that best practices should be followed for all ponds to avoid leakage either through the bottom or through flooding and to include at least the following: thick, high-quality double liners, clay liners, leak detection systems, procedures for frequent checking of leak detection systems, and the maintenance of substantial empty space in the ponds to accommodate flood events.**

Response #288:

EPA considered effects from the ponds and determined that they are acceptable given the permit condition included in the Area Permits as described above in Response #287. Sections 3.3.4.1 and 3.3.4.2 of the CEA address this issue. EPA conducted an analysis on old boreholes and ponds and made the following conclusions for the Burdock and Dewey areas: Regarding the Burdock Area, the CEA concluded that based on the Class III permit application the Burdock ponds do not appear to be located where any historic boreholes have penetrated the Graneros Shale. See Figures 14a and 14b in Sections 3.3.4.2 of the CEA. Therefore, the CEA concluded that there was no concern regarding leakage into deeper aquifers through improperly plugged boreholes.

Regarding the Dewey Area, the CEA concluded that there are no concerns related to historic boreholes based on Figure 9a (See Section 3.3.4.1 of the CEA) under the deep injection well disposal method. However, under the land application disposal method, Figure 9b of Section 3.3.4.1 indicated that there were some drillholes in the proposed location of the storage ponds and one drillhole located in the spare storage pond. Given this co-location, the CEA concluded “as currently proposed, [the ponds] do not have a secondary HDPE liner over the clay liner, no leak detection systems and the drillholes could be a potential breach in the Graneros confining zone if not plugged in a manner that prevents leaks.”

EPA does not directly regulate ponds through the Safe Drinking Water Act Underground Injection Control Program and cannot incorporate recommended best practices for them under our permits. However, because leaking ponds can endanger USDWs, the Class III and V permits require the Permittee to submit information to EPA for a Clean Air Act (CAA) applicability determination prior to receiving authorization to inject. Subpart W of the CAA includes the standards that dictate the design, construction, and installation of applicable impoundments (40 CFR § 192.32(a)(1)). These rules typically apply to structures such as those at the proposed Dewey-Burdock uranium recovery facility, including all impoundments or ponds where uranium byproduct material is stored or treated. Such ponds would include those storing treated uranium byproduct material prior to either land application or deep well injection.

Regarding the potential for floods, EPA determined that the combination of sediment control structures to protect ponds, additional spare ponds, and the requirements under 40 CFR §§ 264.221(c), 264.221(g), 264.221(h), and 40 CFR § 192.32(a)(1) provide adequate assurance to protect the ponds against the impacts of flood events.

**289. Some commenters recommended that the building of ponds in the 500-year floodplain should be prohibited, given the increase in flooding incidents in the area. They recommended that the design of sediment control structures should protect the ponds from events larger than a 5-year, 24-hour precipitation event, especially because the mine and the ponds will be present for up to twenty years. The commenters did not agree with EPA that impacts would be minimal because a flood could wash-out sediment structures or overflow a pond containing hazardous materials.**

Response #289:

The ponds that are located in a potential flood plain are the land application storage ponds at the Dewey Site. These ponds will contain treated process water ready for release through the land application disposal method. The water quality in these ponds must meet the requirements of the DENR proposed Groundwater Discharge Permit. The design criteria for a five-year, 24-hour precipitation event that the commenters mention are applicable only to the sediment control structures, such as sediment ponds and traps, associated with wellfield construction. Diversion channels, not sediment control structures, are the features that will be used to divert stormwater around the treatment and storage ponds. Diversions of ephemeral channels, such as the drainage channel located at the Dewey land application storage ponds, will be designed to have the ability to contain the discharge from a 100-year, 24-hour precipitation event. In addition, the ponds will be protected by berms that will most likely be subject to the requirements of 40 CFR part 61, Subpart W. These construction standards are found at 40 CFR § 264.221, which includes the following requirements that will minimize potential impacts to stormwater:

40 CFR § 264.221(g) A surface impoundment must be designed, constructed, maintained, and operated to prevent overtopping resulting from normal or abnormal operations; overfilling; wind and wave action; rainfall; run-on; malfunctions of level controllers, alarms, and other equipment; and human error.

40 CFR § 264.221 (h) A surface impoundment must have dikes that are designed, constructed, and maintained with sufficient structural integrity to prevent massive failure of the dikes. In ensuring structural integrity, it must not be presumed that the liner system will function without leakage during the active life of the unit.

Section 4.3.1 of the CEA discusses EPA's review of Powertech's analysis of potential flood events at the Dewey-Burdock Project Area. Powertech's analysis is discussed in more detail in Section 3.5.2.3 of Powertech's Large Scale Mine Proposed Permit. Powertech's flood analysis includes estimates of peak flood discharges and water levels produced by floods on Pass Creek, Beaver Creek and local small drainages that could potentially impact the Dewey-Burdock Project Area. Powertech used three models to evaluate flood impacts on the Beaver Creek drainage. Two of these models produced flood estimates including results for the 100-year, 500-year and an extreme event greater than the 500-year flood event. These results are summarized in Tables 3.5-1 and 3.5-3 of the Large Scale Mine Permit proposed permit.

EPA also reviewed the proposed diversion and berm structures that Powertech has designed to divert stormwater around the pond locations. Section 4.2.3 discusses the diversion channels that Powertech proposes to use to direct stormwater flow around the processing facilities, ponds, and wellfields. Based on this review, EPA maintains that impacts from floods at the Dewey-Burdock site will be acceptable.

**290. A commenter stated that the Administrative Record is silent on the ecologic impact of process ponds containing toxic solutions, and the viability of the mitigation measures. Specifically, the commenter notes that Section 14.0 "Impacts to Ecological Resources" did not include analysis of direct and cumulative impacts to migratory birds and bats exposed to toxic solutions that the projects' process-related ponds contain.**

Response #290:

EPA disagrees with the commenter's assertion that the administrative record is silent on the ecologic impact of process ponds. The Biological Assessment does address chemical constituents in the process ponds—as it relates to the three federally-listed ESA species—and includes mitigation measures that are requirements of the Class III and Class V area permits to avoid, minimize, or mitigate potential impacts that the SDWA actions may have on these three federally-listed ESA species. For example, the Class III and Class V area permits require Powertech to install netting, use bird balls, or other acceptable bird deterrent methods to prevent ESA-listed species from accessing the ponds as a mitigation measure. While this permit requirement is intended to protect the federally-listed species, it will have the incidental benefit of similarly deterring other migratory birds and bats.

With respect to Endangered Species Act federally-listed species potentially affected by EPA's actions: the northern long-eared bat; the rufa red knot; and the whooping crane, Section 14.1 of the CEA references the ESA consultation process. EPA has prepared a Biological Assessment and has concluded the consultation process with the Fish and Wildlife Service in accordance with Section 7(a)(2), 16 U.S.C. §1536(a)(2) of the Endangered Species Act. While the CEA does not specifically discuss impacts to migratory birds and bats, EPA considered this issue and finds that potential impacts of the SDWA actions, including the process ponds, on ecological resources are acceptable, based on: its review of information that Powertech has submitted to date, including the wildlife and vegetative surveys; the ESA-required pond deterrent measures included in our permits; and the requirements Powertech has to comply with under South Dakota law for a large scale mine permit as described in Section 14.3 of the CEA.

**291. Powertech asserted that no justification appears to be provided for the statement that a leak from a pond storing treated water will result in “extensive impact ... which will be difficult and expensive to remediate” by the time the leak is detected in the pond detection monitoring system required by the NRC. According to Powertech, the pond detection monitoring system required by License Condition 12.25 in SUA-1600 will be designed as an early warning system using non-hazardous indicator parameters, similar to what is done for excursion monitoring in the wellfields. Powertech further asserted that based on this requirement, the fact that the ponds with single HDPE liners overlying clay liners will only store treated water, and the fact that the ponds will be about 1 mile away from Pass Creek, there is a low likelihood of an “extensive impact” from a pond leak. Powertech requests revising this discussion to address these considerations.**

Response #291:

EPA does not agree with Powertech about the potential impacts from a pond leak in this area. EPA performed an analysis of the geological conditions underlying the Burdock Area Ponds to evaluate impacts from the potential leaking of ponds. EPA has concerns that although the ISR waste fluids would have been treated to remove radium, the stored water would still contain byproduct material and high TDS reject water from the reverse osmosis treatment system. Leaking from ponds in this area have the potential to affect alluvial aquifers. Plate 3.6-10 in the Groundwater Discharge Permit Application shows cross-sections of the Pass Creek alluvium and Appendix 3.6-A contains logs from Pass Creek alluvial



wells. Figures T and U shows the Pass Creek alluvium cross section near the locations of the Burdock Area treatment and storage ponds. Figure T shows the Burdock Area Pond locations for the Class V disposal option; Figure U shows the Burdock Area Pond locations for the land application disposal option. Although the Pass Creek alluvium is dry at the pond locations, a pond leak could potentially travel along the base of unconsolidated alluvial silty clay to reach the sand and gravel lens shown in Figure T.

Because of EPA’s concern about potential effects to these alluvial aquifers, EPA included a condition in Part II, Section I.4.a of the Class III Area Permit requiring the Permittee to submit information to the EPA Region 8 Air and Radiation Division to determine the applicability of the 40 CFR part 61, subpart W regulations, and if necessary, receive construction approval from EPA. If CAA subpart W applies to these ponds, Powertech will need to meet subpart W requirements. The surface impoundment design, construction, and operating requirements are found under 40 CFR § 264.221(c) which requires two or more liners, installation of a leak detection system, and a leachate collection and removal system between such liners.

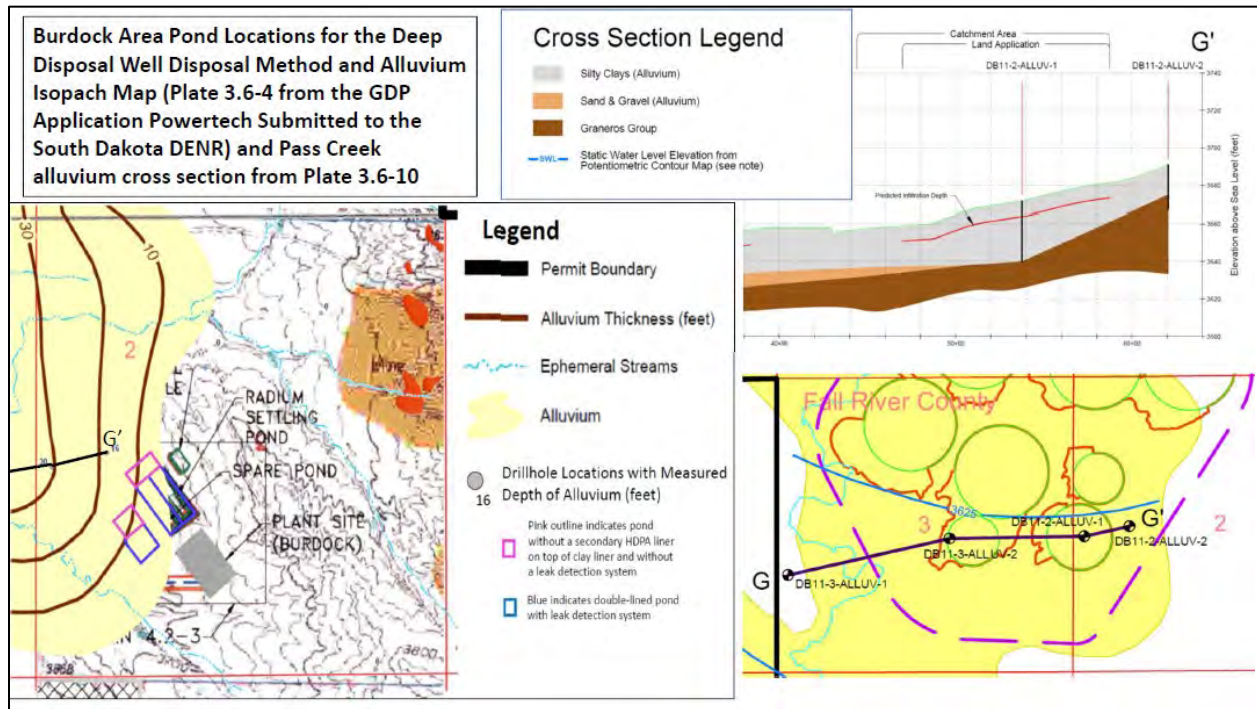

Figure T. Pass Creek alluvium cross-section and the Burdock Area Pond locations for the Class V disposal option.

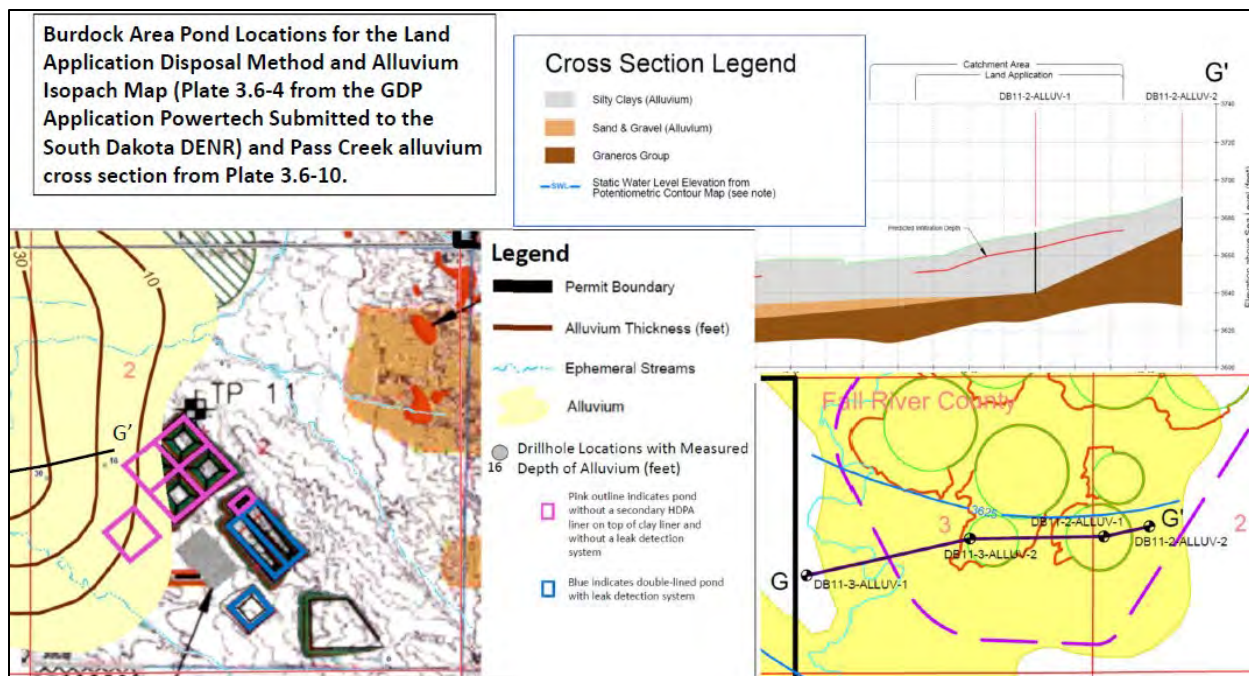

Figure U. Pass Creek alluvium cross-section and the Burdock Area Pond locations for the land application disposal option.

292. A commenter asserted that the mitigation measures are merely plans to be submitted in the future to address other impacts, including air impacts, land disposal of radioactive waste, wildlife protections, and BMPs for storm water control. The commenter also raised concerns that such future mitigation plans are outside of the public process and shielded from public review or comment, and that such assurances, without any details as to the mitigation to be proposed and without evaluation of how effective these restorations efforts are expected to be, do not satisfy EPA’s obligations. The commenter further stated that: “many of the most crucial mitigation proposals are simply proposals to develop mitigation plans in the future. Reliance on a future, as yet-unsubmitted, mitigation to prevent/mitigate adverse impacts to the resources at the site fails to provide the detail necessary to gauge the impacts of the proposed mining operation.”

Another commenter stated that another example of a mitigation plan that is left to future development are the avian and wildlife impact and mitigation plans that are being developed in concert with state and federal agencies necessary to keep wildlife from being exposed to potential contamination risks from mine site facilities. The commenter was critical that: details of these plans are not proposed to be developed until approved by the South Dakota Department of Environment and Natural Resources and Game and Fish as a permit condition before any construction begins. Thus, the commenter was critical that instead of analysis in EPA documentation, the Agency simply lists possible mitigation measures without a meaningful review of the details or the effectiveness of the proposed measures. This in turn leaves the public without the ability to provide meaningful input on the mitigation plans.

Response #292:

EPA is mindful that some of the mitigation measures identified in the cumulative effects analysis are only required in draft, not final, state permits. However, this is the most current information regarding the intent of both the State and Powertech with respect to mitigative permit conditions. EPA determined that the available information contains adequate detail and was appropriate to include in the Cumulative Effects Analysis because it represents the applicant's intent to follow the proposed requirements and mitigation measures, which are under the NRC and the SD DENR's regulatory authorities. These regulatory entities will also hold their own public processes prior to finalization of their actions.

Based on the information before us, EPA determined that with the mitigation measures discussed in the CEA, environmental effects from the project are acceptable. If the requirements and mitigation measures relied upon to make this conclusion change, EPA will have an opportunity to re-evaluate the cumulative impacts on the environment, and if they are no longer acceptable, EPA can modify the UIC permits. See 40 CFR § 144.39(a)(1). Such a modification would be subject to a public participation process in accordance with 40 CFR § 144.39 and Part 124.

**293. Several commenters stated that many key aspects of this CEA rely upon non-existent "permits." A commenter stated:**

**[E]xamples are almost too numerous to count, but suffice it to say that unless these non-existent 'permits' are actually issued, information based on them should be omitted from EPA's documents. EPA documents also refer repeatedly to the requirements of an NPDES permit that has not even been applied for. And they refer frequently to a state Large Scale Mine Permit that has just barely begun the hearing process and is far from issuance. To rely on non-existent regulatory instruments for large portions of the permitting documents indicates both problems with the regulatory process and a lack of analysis of the proposed mine, deep disposal wells, and aquifer exemption. Some other examples of the reliance upon non-existent "permits" for key aspects of the Cumulative Effects analysis can be found pages 36, 39, 51, 53, 54, 55, 60, 61, 67, 71, 72, 74, 75, 79, 83, 88, 96, 109, 125, 132, 137, 138, 139, 140, 142, and 143. Until if and when the suggested permits are issued, information based on non-permits should be omitted from EPA's documents. A realistic, complete EPA analysis should be done.**

Response #293:

As explained above in Response #292, EPA acknowledges that the CEA describes mitigation measures based on draft, rather than final, state permit conditions. Please refer to Response #292.

**294. A commenter asserted that the CEA relies upon the GDP and NPDES permits for statements that the land waste disposal option will be safe and that there will be no contamination. The commenter asserts that such statements run counter to the research on this topic, which indicates a build-up of highly toxic selenium at a similar site.**

Response #294:

The commenter refers to the CEA's discussion of the proposed DENR Groundwater Discharge Permit (GDP) and construction and industrial stormwater NPDES permits related to EPA's assessment of the land application disposal option. EPA relied on the proposed permits because these activities are regulated by other agencies which would have the best information on these topics.

As discussed in Response #272 above, Powertech anticipates that metal concentrations in the land applied fluids will be at or below human health standards set by the South Dakota water quality regulations, but acknowledges there is potential for buildup of metals and metalloids over time in the land application areas. Powertech has committed to mitigating potential impacts by monitoring soil concentrations during operations and implementing a contingency plan if soil concentrations approach trigger values. Table 8.3-1 of the GDP presents the proposed trigger values for arsenic and selenium in surface and subsurface soil, which are baseline average concentrations plus two standard deviations. Additionally, as described in Section 4.7.2 of the CEA, the NRC License requires that radioactive constituents in liquid effluents applied to land application areas be within allowable release limits. Further, the draft DENR GDP requires Powertech to comply with applicable state discharge requirements for land application of treated wastewater and requires that such application activities occur so that no ponding and no runoff of effluent (e.g., wastewater solutions) occur.

Based on the information before us, EPA determined that with the mitigation measures discussed in the CEA, environmental effects from the project are acceptable. If the requirements and mitigation measures relied upon change, EPA will have an opportunity to re-evaluate the cumulative impacts on the environment, and if they are no longer acceptable, EPA can modify the UIC permits. See 40 CFR § 144.39(a)(1). Such a modification would be subject to a public participation process in accordance with 40 CFR § 144.39 and Part 124.

**295. A commenter asserted that the application material and EPA analysis inappropriately defers meaningful review of mitigation until later permits to be considered by the State of South Dakota. The commenter noted that these deferred analyses include detailed monitoring and mitigation plans for the state of South Dakota permits associated with the potential land application of wastes, as well as the groundwater discharge permit for the land application. According to the commenter, definition of critical features is left to the future, such as the monitoring program with wells that define the perimeter of operational pollution.**

Response #295:

EPA reviewed the groundwater discharge permit application for the land application option and the South Dakota Ground Water Quality Program's [December 12, 2012 Conditions for the Land Application Disposal System](#) in evaluating cumulative effects.

The first condition the Ground Water Quality Program imposed stated: *The Ground Water Discharge Plan application, along with any amendments and technical revisions shall become part of these conditions, with the exception of those items specifically added, deleted, or amended in these conditions to the plan*, which means Powertech's commitments in the Groundwater Discharge Permit application

are enforceable permit conditions. Even though the permit has not been approved as final by the South Dakota Water Management Board, the proposed permit requirements are reasonable for EPA to consider as part of the cumulative effects analysis. If the Groundwater Discharge Permit requirements that EPA relied on change, the UIC regulation at 40 CFR § 144.33(d) specifies that if the Director determines that cumulative effects are unacceptable, the permit may be modified under § 144.39.

Section 6.0 of the Groundwater Discharge Permit application includes details about the monitoring plans designed to comply with the requirements under South Dakota's groundwater quality regulations. The requirements included in South Dakota's regulations provide additional information EPA included in its analysis. Section 6.0 of the GDP provides a description of the operational monitoring plan including sampling frequency, sampling methods, analytes and analytical methods. Section 6.1.1.4 discusses the permit compliance limits. Section 6.1.2 discusses the bedrock aquifer groundwater monitoring plan for the Fall River Formation. Section 6.1.3 discusses the plan for monitoring in the vadose zone (the unsaturated area above the groundwater table).

Figure 6.1-1 of the GDP application shows the locations of the proposed Perimeter of Operational Pollution (POP) areas and proposed alluvial monitoring wells for the Dewey land application area. Well DC-1 DC-2, DC-3 and DC-4 have already been constructed and groundwater monitoring data from these wells are available. Figure 6.1-2 shows the POP area and locations of the proposed alluvial monitoring wells for the Burdock land application area. Wells BC-1 and BC-2 and have already been constructed and groundwater monitoring data from these wells are available. A third well, BC-3, not shown in Figure 6.1-2, but shown in Plate 3.1 of the Class III Permit Application, has also been constructed with groundwater data available. Alluvial well monitoring results are available on the Ground Water Program website: [https://denr.sd.gov/des/gw/Powertech/Powertech\\_GW\\_Discharge\\_Permit.aspx](https://denr.sd.gov/des/gw/Powertech/Powertech_GW_Discharge_Permit.aspx) (last visited: October 9, 2020).

In Section 6.1.2 of the GDP application Powertech explains that due to the thickness and confining properties of the Graneros Group shales, which separate the proposed land application systems from Fall River aquifer (the first bedrock aquifer encountered below the Graneros Shale), no compliance monitoring wells are proposed in Fall River aquifer. Powertech refers to Plates 3.6-3 and 3.6-5 through 9 to demonstrate that the thickness of the Graneros Group is never less than 25 feet in the land application areas.

EPA reviewed drillhole data along northeastern POP boundary in the Burdock Area. Figure V shows the Burdock POP boundary from Groundwater Discharge Permit application. Figure 6.1-3 contains an excerpt from Plate 6.12 of the Class III Permit Application showing available cross-sections in the Dewey-Burdock Area. According to Class III Permit Application Plate 6.18 Cross-Section F-F', logs of drillholes TRM 33 and TRM 34 show 10 feet of Graneros Shale. Because the Graneros Shale has been eroded away in this area, logs of drillholes DRJ 70 and DRJ 90 show the Graneros Shale is absent above the Fall River Formation. Because these drillhole locations are located outside the POP boundary, they do not necessarily indicate the Graneros is less than 25 feet thick within the land application areas. Groundwater Discharge Permit application Plates 3.6-9 Cross-Section E-E' and Plate 3.6-8 Section D-D' show that the Graneros shale is 25 feet or more within the land application areas. Cross-Section F-F' in Plate 6.12 of the Class III Permit Application also shows that the Upper Fall River is not saturated at the locations of drillholes TRM 34, DRJ 70 and DRJ 90. Powertech proposes vadose zone monitoring at catchment areas (which are shown in Figures 6.1-2). EPA considered whether monitoring wells should



be completed in the Fall River aquifer at the northeastern POP boundary and determined that the catchment area vadose zone monitoring at the northeastern edges of the Burdock land application area will also serve as monitoring for the Fall River aquifer in this area. In addition, the Upper Fall River aquifer monitoring wells associated with Burdock Wellfield 8 will also provide monitoring for TDS, specific conductance, and alkalinity at the northeastern POP boundary.

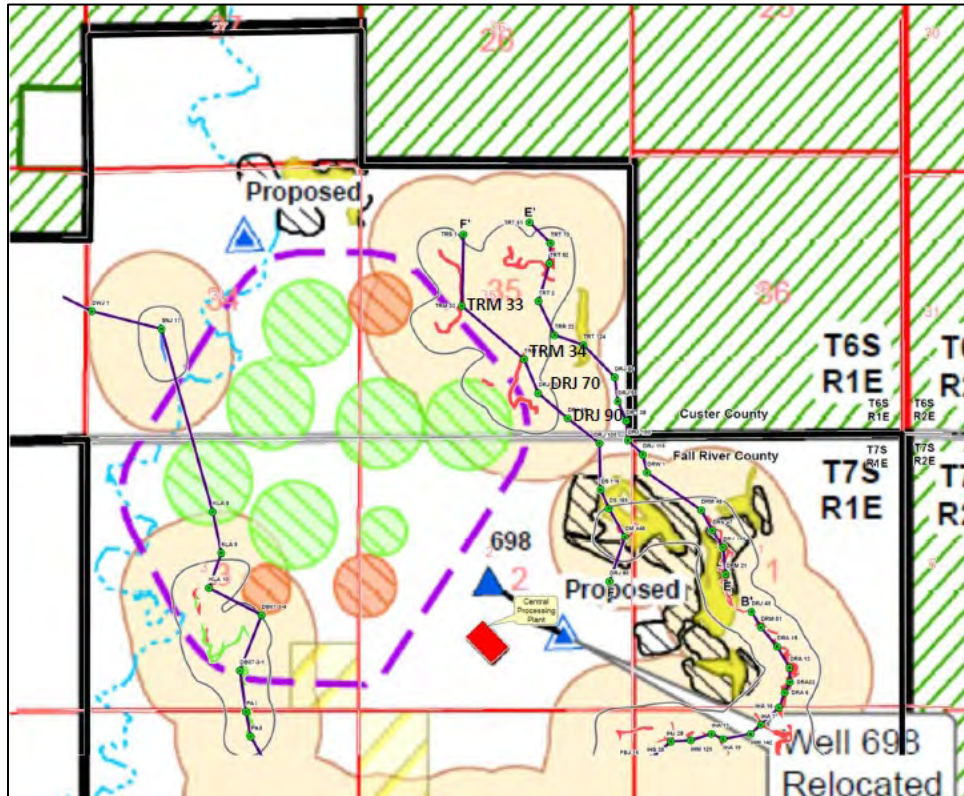

**Figure V. Burdock Area Land Application Area and proposed Perimeter of Operational Pollution (Sources: Groundwater Discharge Permit application Figure 6.1-3 and Class III Permit Application Plate 6.12)**

Powertech will also conduct operational groundwater monitoring as required under the NRC License and Part IX, Section B.3.c of the Class III Area Permit. Powertech proposes providing DENR with the results from operational monitoring wells in the Fall River Formation. Figure 6.1-3 shows the locations of the Fall River monitor wells currently proposed in the Burdock Area.

Section 7.0 of the GDP application provides information about the Proposed Perimeter of Operational Pollution (POP). As stated in the Groundwater Discharge Permit application, the POP zones must meet the requirements of ARSD 74:54:02:17 to protect groundwater resources. Each of the proposed POP zones is within one-quarter mile of the Dewey and Burdock land application areas and within the Dewey-Burdock Project Boundary. The proposed POP zones around the land application areas are shown in Figures 6.1-1 and 6.1-2 for the Beaver Creek and Pass Creek alluvial deposits, respectively. The locations of the compliance and interior monitoring wells are also shown in these figures. The monitoring strategies for the compliance and interior monitoring wells are discussed in Section 6.1.1.1 of the Groundwater Discharge Permit. Section 8.1.1 includes a contingency plan should the water quality in the interior monitor wells indicate an increasing trend in constituent concentrations that could potentially trigger a permit limit violation at a compliance well.

Section 5.7 of the Groundwater Discharge Permit application discusses how Powertech used Soil-Plant-Atmosphere-Water (SPAW) modeling to estimate disposal capacity for the land application system and to estimate the water budget for the storage ponds and catchment areas. The SPAW modeling process was designed by and available from the US Department of Agriculture, Natural Resources Conservation Service. According to the [USDA, Natural Resources Conservation Service website](#), it is a water budgeting tool for farm fields, ponds and inundated wetlands. The SPAW model performs daily hydrologic water budgeting using the SCS Runoff Curve Number method. Soil Water Characteristics is a program included with the SPAW installation. It is used to simulate soil water tension, conductivity and water holding capability based on the soil texture, with adjustments to account for gravel content, compaction, salinity, and organic matter. SPAW climate data files are also available on the website.

Section 8.0 of the Groundwater Discharge Permit application includes detailed descriptions of mitigation measures for protection of alluvial groundwater, Fall River aquifer groundwater, surface water, soil (contamination prevention and protection of fertility), vegetation, and livestock and wildlife. Mitigation measures are a summary of permit requirements for land application control, monitoring and contingency plans to prevent contamination. Section 8.1.3 discusses how Powertech used the SPAW model to estimate the potential post-closure impacts of the land application system by determining if there would be a potential for continuing downward migration of water and salts after cessation of land application operations.

Based on the information available in the Groundwater Discharge Permit application discussed in this response, EPA concludes that meaningful review of monitoring and mitigation plans for the land application of ISR waste fluids is possible without waiting until the Groundwater Discharge Permit is final. EPA concludes that critical details about monitoring and mitigation plans are available for EPA analysis of impacts from the potential land application of wastes. These critical details described in the permit application/permit include the monitoring program with wells defining the perimeter of operational pollution that were specifically mentioned by the commenter and the alluvial monitoring plan and location of alluvial monitoring wells.

**296. A commenter stated that instead of presenting well-developed mitigation plans and analyzing their effectiveness in eliminating impacts, EPA and the applicant simply list and mention mitigation measures and assert that they may be successful in eliminating or substantially reducing the Project's adverse impacts. The commenter asserts that these lists lack any detail necessary for the decisionmakers or public to assess the likely effectiveness of these measures. The commenter explains that under relevant administrative law, a competent cumulative impact review requires that assertions of effectiveness must be supported by substantial evidence in the record. The commenter asserts that without the necessary analysis in the impact review, EPA conclusions are arbitrary and capricious in relying on mitigation to conclude that there would be no significant impact to impacts resources. Further, many of the most crucial mitigation proposals are simply proposals to develop mitigation plans in the future. Reliance on a future, as yet-unsubmitted, mitigation to prevent/mitigate adverse impacts to the resources at the site fails to provide the detail necessary to gauge the impacts of the proposed mining operation. Despite having none of this information or plans developed,**

EPA nevertheless concludes that the risks of this type of contamination are expected to be small. Such unsubstantiated conclusions based on unsubmitted, unreviewed, and even undeveloped mitigation plans are not allowable under the SDWA, UIC regulations, NEPA, or APA.

The commenter includes the following examples of mitigation measures that are not fully developed:

- 1) Such basic and critical things as post-permit issuance aquifer pumping tests in each wellfield to examine the hydraulic integrity of the Fuson Shale, which separates the Chilson and Fall River aquifers;
- 2) There is no discussion on what methodology or effectiveness criteria accompanies the pump tests or monitoring well systems.
- 3) Delay on obtaining data to be included in the hydrologic wellfield packages which encompass mitigation for a broad scope of impacts, including such basic elements as to determine the ability to contain mining fluids.
- 4) A commitment from the applicant to locate unknown boreholes or wells identified through aquifer pump testing, and commitment to plugging and abandoning historical wells and exploration holes, holes drilled by the applicant and any wells that fail mechanical integrity tests.
- 5) There is no discussion or analysis provided to explain how an applicant might go about identifying abandoned holes or analyzing the effectiveness of long-after-the-fact plugging and abandonment.
- 6) Other proposed groundwater impact mitigation that lacks reasonably complete review and analysis as to effectiveness include a proposed, but unevaluated, monitoring well network for the Fall River aquifer in the Burdock area for those wellfields in which the Chilson aquifer is in the production zone in order to address uncertainties in confining properties of the Fuson Shale because leakage may occur through the Fuson Shale and draw-down induced migration of radiological contaminants from abandoned open pit mines in the Burdock area.
- 7) Similar gaps in the analysis exist in the failure of EPA analysis to assess a plan to review groundwater restoration only for a period of 12 months. There is no support of basis for this time period, nor any discussion of the basis or effectiveness of such a time period. Further, no alternative time periods were analyzed.
- 8) Historic evidence demonstrates that ISL uranium mines have a very poor record of restoring ground water aquifers – in fact, none have ever actually restored an aquifer used to conduct ISL uranium mining. EPA cannot provide information to the public concerning unmitigated impacts where groundwater mitigation plans have not been developed or analyzed for effectiveness.

Response #296:



EPA's obligation to review cumulative effects for area permits comes from 40 CFR § 144.33(c)(3) which allows issuance of an area permit if: "[t]he cumulative effects of drilling and operation of additional injection wells are considered by the Director during evaluation of the area permit application and are acceptable to the Director." The mitigation measures discussed in the CEA were among the things considered by EPA in finding that cumulative effects are acceptable. As discussed in Responses #292 and #295 above, while these measures have not been finalized in permits, this represents the best information on the mitigation that will likely occur. If the information on which we made this decision changes, EPA can modify the permits pursuant to 40 CFR § 144.39(a)(2). The commenter also lists eight examples of mitigation measures he believes are not fully developed. In the interest of providing information to the public, we respond to each below. However, EPA does not agree that these items are mitigation measures nor do they need to be complete in order to find that cumulative effects are acceptable.

- 1) *Such basic and critical things as post-permit issuance aquifer pumping tests in each wellfield to examine the hydraulic integrity of the Fuson Shale, which separates the Chilson and Fall River aquifers.* Aquifer pump testing is not a mitigation measure. It does not need to be completed to assess potential effects and mitigation measures. As discussed in Responses #20 and #35 above, UIC regulations contemplate the collection of data after permit issuance but prior to EPA's issuance of an authorization to inject for the injection wells. In addition, the UIC Class III Area Permit must be issued as final in order for the detailed permit requirements related to design and implementation of the wellfield aquifer pump tests and design of the associated wellfield monitoring system to be enforceable. Part II of the Class III Area Permit provides adequate detail about how the requirements provide the necessary information about the hydraulic integrity of the Fuson Shale. In addition, Section 5.0 of the 2019 Fact Sheet for the draft Class III Area Permit provides a detailed explanation about how the wellfield aquifer pump tests and wellfield monitoring system will provide information about the effectiveness of the Fuson confining zone, and other confining zones in controlling injection zone fluids.
- 2) *There is no discussion given to what methodology or effectiveness criteria accompanies the pump tests or monitoring well systems.* As stated above, the aquifer pump test is not a mitigation measure. EPA included information about the methodology and effectiveness criteria for the wellfield aquifer pump tests and monitoring well systems in the Class III Area Permit and Fact Sheet for the draft Class III Area Permit. Part II, Section D of the Class III Area Permit includes the requirements for the Design and Construction of Wellfield Monitoring Well System. Section 5.2 of the draft Class III Area Permit Fact Sheet, *Monitoring System Design*, explains the criteria the monitoring well system must meet and how compliance is determined.

Part II, Section F of the Class III Area Permit includes the Wellfield Pump Test Requirements. Section 4.2.3 of the Fact Sheet for the draft Class III Area Permit discusses three strategies that the Permittee has used or will use to locate improperly plugged historic drillholes. One strategy includes identification of locations where groundwater is flowing to the surface, for example at the alkali area. Another strategy is to provide a detailed investigation of the Pass Creek and Beaver Creek alluvium to look for areas where groundwater from underlying aquifer is upwelling into the alluvium. The third strategy is implementation of wellfield pump tests to locate improperly plugged historic drillholes so they can be mitigated before the commencement of

injection activities. There will be two methods for detecting leaky historic drillholes during the wellfield pump tests. The first is detailed mapping of the aquifer potentiometric surfaces. With the high density of delineation drillholes and pump test wells, any leakage across confining zones due to improperly plugged drillholes will become apparent while preparing potentiometric surface maps based on water levels measured in the delineation drillholes and the wellfield pump test wells. However, in the areas where the potentiometric surfaces of the Fall River and Chilson aquifers are at nearly the same elevation, this method will not be useful. The second is the detection of any water level responses in the pump test monitoring wells completed in overlying or underlying aquifers during the aquifer pump test.

Section 5.4 of the Fact Sheet for the draft Class III Area Permit explains the set-up, purpose and method for the wellfield aquifer pump tests and how the pump test procedure will also test the adequacy of the wellfield monitoring well system for meeting the permit requirements. This section also explains how a confining zone breach, such as an improperly plugged historic exploratory drillhole, is identified.

- 3) *Delay on obtaining data to be included in the hydrologic wellfield packages which encompass mitigation for a broad scope of impacts, including such basic elements as to determine the ability to contain mining fluids. See Response 1) above.*
- 4) *A commitment from the applicant to: a) locate unknown boreholes or wells identified through aquifer pump testing; b) commitment to plugging and abandoning historical wells and exploration holes; and c) holes drilled by the applicant and any wells that fail mechanical integrity tests.*
  - a) The actions to address improperly plugged historic drillholes are required by the Class III Area Permit in Parts II and III. The Class III Area Permit must be issued as final for these permit requirements to be enforceable. If the Permittee does not meet these permit requirements, EPA will not issue authorization to inject into the wellfield.
  - b) Part II, Section C.2.h requires the Permittee to plug and abandon all water supply wells within one quarter of a mile of the perimeter monitoring well ring or incorporate them into the monitoring system for the wellfield pump test to determine if they have potential to be impacted by ISR operations or to impact ISR operations. If the wells are improperly constructed and cause a breach through confining zones, the Permittee must plug and abandon the wells or perform corrective action on the well to remove any breaches in confining zones. (The requirement to plug historic exploration boreholes is addressed under 4a above).
  - c) Part II, Section D.4.e of the Class III Area Permit states: The Permittee must plug and abandon any monitoring well for which mechanical integrity cannot be demonstrated. The plugging and abandonment procedures shall be conducted according to the requirements under Part XI.

Part II, Section, B.3 of the Class III Area Permit requires the Permittee to plug and abandon wellfield delineation drillholes that are not used for injection, production or monitoring well construction. Plugging methods must ensure that the integrity of all intersected confining

zones remains intact. The integrity of intersected confining zones must be demonstrated by the results of the wellfield pump test required under Part II, Section F.

Part VI, Section B.5 of the Class III Area Permit states: If mechanical integrity cannot be successfully demonstrated following a workover, the well must be plugged and abandoned according to the approved plugging and abandonment plan in Part XI, Section C.

- 5) *There is no discussion or analysis provided to explain how an applicant might go about identifying abandoned holes or analyzing the effectiveness of long-after-the-fact plugging and abandonment.* This information is included in 2) above.
- 6) *Other proposed groundwater impact mitigation that lacks reasonably complete review and analysis as to effectiveness include a proposed, but unevaluated, monitoring well network for the Fall River aquifer in the Burdock area for those wellfields in which the Chilson aquifer is in the production zone in order to address uncertainties in confining properties of the Fuson Shale because leakage may occur through the Fuson Shale and draw-down induced migration of radiological contaminants from abandoned on pit mines in the Burdock area.*

Response 2) above explains the strategies for dealing with uncertainties about the integrity of the Fuson Shale confining zone. EPA concludes that there will be no impacts to Fall River groundwater quality in the Burdock Area from ISR operations in the Chilson. The NRC license, the DENR proposed Large Scale Mine Permit and Part IX, Sections B.2.c and d of the Class III Area Permit require the Permittee to install monitoring wells in SWNE Section 34 T6S, R1E downgradient from the Triangle Mine and at NWSE Section 2, T7S, R1E downgradient of the Darrow pits to monitor any changes in Fall River aquifer groundwater quality during ISR operations.

As discussed in Response #247 above, EPA evaluated potential impacts from the abandoned uranium mines during evaluation of the area permit and determined EPA does not anticipate cumulative effects in common with the Dewey Burdock project. EPA's consideration of this issue can be found in the Fact Sheet for the draft Class III Area Permit Section 4.8. As stated above, in order to verify this conclusion and ensure protection of adjacent USDWs, including the Fall River aquifer, EPA included a requirement for monitoring wells downgradient of the Triangle and Darrow pits to evaluate any impacts from the abandoned uranium mines during ISR operations.

The Triangle pit is filled with groundwater from the Upper Fall River aquifer. Burdock Wellfield 10, located downgradient from the Triangle pit, is targeting ore in the Lower Fall River. The extent of the confining zone between the Upper and Lower Fall River aquifer has been demonstrated through exploratory drillhole logs as shown in the cross-section plates Powertech submitted with the UIC Class III Permit Application. As stated in the Fact Sheet for the draft Class III Area Permit Section 4.8, the inward groundwater gradient that must be maintained during uranium recovery operations and subsequent groundwater restoration at Burdock Wellfield 10 has the potential to pull the Triangle Pit water down-gradient at a faster rate than is already occurring under the natural groundwater flow regime. The NRC license, the DENR propose Large Scale Mine Permit, and Part IX, Sections B.2.c and d of the Class III Area Permit require the Permittee to install a monitoring well in the Fall River aquifer in SWNE Section 34 between the

Triangle Mine and Burdock Wellfield 10 to detect in changes in Fall River groundwater quality downgradient from the Triangle Mine

- 7) *Similar gaps in the analysis exist in the failure of EPA analysis to assess a plan to review groundwater restoration only for a period of 12 months. There is no support or basis for this time period, nor any discussion of the basis or effectiveness of such a time period. Further, no alternative time periods were analyzed.* Because ISR operations will be occurring in exempted portions of the Inyan Kara aquifers, which are not protected under the SDWA, the Class III Area Permit contains no requirements for groundwater restoration. Section 11.0 of the Class III Area Permit discusses the groundwater restoration process Powertech proposed for the NRC License for informational purposes only. The NRC License anticipates wellfield groundwater restoration to take about two years. License condition 10.6 states if the licensee determines that these activities are expected to exceed 24 months for any particular production area, the licensee shall submit an alternate schedule.

The commenter may be referring to the stability monitoring phase that occurs after NRC has determined that groundwater restoration is completed. License condition 10.6 states that the licensee shall conduct sampling of all constituents of concern on a quarterly basis during restoration stability monitoring. The sampling shall include the specified production zone aquifer wells. The applicant shall continue the stability monitoring until the data show that the most recent four consecutive quarters indicate no statistically significant increasing trends for all constituents of concern that would lead to an exceedance above the respective standard in 10 CFR part 40, Appendix A, Criterion 5B(5). Stability monitoring may take longer than 12 months before four consecutive quarters of monitoring data indicate no statistically significant increasing trends for all constituents of concern.

The Class III Area Permit contains monitoring requirements for the post-restoration stability monitoring phase in order to provide groundwater quality data for development of a geochemical model for each wellfield. Part IV, Section C.1.b requires that once post-restoration stability monitoring begins, the Permittee must conduct quarterly water quality monitoring for parameters listed in Table 8 in accordance with Part IX, Section B.4. Part IV, Section D.1.a states: After the post-restoration stability phase is completed and the geochemical model has been calibrated, the Permittee must conduct reactive transport modeling to evaluate the long-term geochemical stability of the restored wellfield and the potential for ISR contaminants to cross the aquifer exemption boundary. The Permittee must submit this information for EPA review as part of a Wellfield Closure Plan described under Part IV, Section D of the Class III Area Permit.

- 8) *Historic evidence demonstrates that ISL uranium mines have a very poor record of restoring ground water aquifers – in fact, none have ever actually restored an aquifer used to conduct ISL uranium mining. EPA cannot provide information to the public concerning unmitigated impacts where groundwater mitigation plans have not been developed or analyzed for effectiveness.* EPA agrees with the commenter's assessment that previous groundwater restoration efforts at uranium ISR sites have not been able to restore all ISR contaminants to pre-mining concentrations or MCLs. As stated in the previous response, EPA has no role in evaluation of groundwater restoration and stability monitoring. EPA applies the Class III Area Permit limits at

the aquifer exemption boundary and requires that no ISR contaminants cross the aquifer exemption boundary into the USDW.

**297. Two comments asserted that the CEA should have discussed cultural resources. One stated generally that the CEA “does not reference cultural matters.” Another commenter asserts that the mitigation measures portion of the CEA insufficiently discusses cultural resource impacts, because “the mitigation analysis consists largely, if not exclusively, of a list of plans to be developed later, outside the permitting process and the public review.” The commenter states that “with regard to the cultural resources impacts, the agency concedes that consultation is not complete, although that is the process through which impacts are assessed and mitigated.” The commenter further asserted that “reliance on a discredited Programmatic Agreement (‘PA’) is insufficient. Indeed, the PA itself simply defers mitigation planning to some future time.”**

Response #297:

Under EPA’s regulations, in issuing a UIC area permit, the “cumulative effects of drilling and operation of additional injection wells” must be “considered” by the official issuing the permit, and these effects must be found “acceptable” by the official signing the permit. 40 C.F.R. § 144.33(c). EPA does not agree that this regulation extends to cultural resources. However, even if this regulation were to extend to cultural resources, EPA has considered effects to cultural resources in the review of these area permits, as outlined below. Note that the regulation does not mandate that consideration of cumulative effects be captured in one document. Therefore, EPA did not include a cultural resources discussion in the CEA.

A list of potential cultural resource concerns raised by commenters follows, with a summary of how the agency has considered potential impacts on those resources, and including where appropriate, cross-references to other responses:

- **Water resources:** Some commenters have asserted a cultural interest in aquifers and other water bodies, and in tribal reserved water rights. EPA’s consideration of potential impacts on water resources is addressed at Response #215 and #224-226 above.
- **Animal species:** One commenter referred to “sacred species that depend on the aquifer.” To the extent this comment raises a cultural resource concern, EPA concludes that our consideration of water resources as described above will sufficiently address the need to protect species dependent on the aquifer. Additional consideration of impacts on some species occurs through the agency’s compliance with the ESA and the agency’s review of requirements Powertech must comply with to assess impacts to other species under state law and the Large Scale Mine Permit, as discussed in Section 14.3 of the CEA.
- **Plant species:** A commenter stated that some plant species are important to tribal practices and customs, such as medicinal plants and timsila (prairie turnips). EPA’s consideration of potential effects on plant species generally is discussed at Response #367.
- **Cultural and spiritual interests in the Black Hills as a sacred site:** The EJ Analysis describes and considers potential impacts to Tribal cultural and spiritual interests in the Black Hills as a sacred site. See section 9 of the EJ Analysis and Responses #243-245 above.

- Historic properties considered under the National Historic Preservation Act (NHPA): Many commenters cited concerns about impacts on historic properties, including ancient migration sites, prayer sites, grave sites and burial mounds, sacred objects, petroglyphs, ceremonial or cultural objects, stone rings, burial mounds, village or battlefield artifacts, and unspecified sacred/spiritual sites, cultural and religious resources, and historic properties. EPA has concluded that these cultural resources have been considered in connection with the NRC's compliance with the NHPA, and that implementation of the NRC Programmatic Agreement will ensure that effects on these resources are minimized. See Responses #234 and #263.

**298. Some commenters stated that EPA relies too heavily on information from Powertech, and other agencies, and doesn't do enough of its own independent research. A commenter stated that the danger of ceding this responsibility to others, especially the mining industry itself, is that permit decisions can be made on the basis of conclusions that look like science, but in reality are technical rationalizations of raw, misguided and dangerous self-interest dangerous to public well-being, for sure, if not to Powertech's bottom line. Another commenter noted that EPA's documents defer repeatedly to the NRC's SEIS for the Dewey-Burdock project, and that the NRC's SEIS document echoed Powertech/Azarga's submissions in all important respects, rather than taking a hard look at the situation. Another commenter stated: To rely on non-existent regulatory instruments and what are essentially the applicant's documents for large portions of the permitting documents indicates both problems with the regulatory process and a lack of analysis of the proposed mine, deep disposal wells, and aquifer exemption. For example, the commenter asserted that EPA signed off on Powertech's proposal to grow crops on the land disposal sites without any analysis of the safety of this practice for wildlife, domesticated animals, or humans.**

**Similarly, a commenter stated that throughout these documents, EPA is legally required to conduct its own environmental analysis, and not just rely on the analyses of other agencies such as the NRC and SD Department of Environment and Natural Resources draft permits/analyses. The commenter further stated that EPA should not rely on the NRC's analysis, recommendations, or regulations. The commenter noted that the processes by the two agencies should be independent, so that the benefits of the expertise and different regulatory focuses of both agencies would be utilized for the proposed operations, as well as the aquifer exemption and other issues. Commenters further noted that reliance on these analyses is improper because they are inadequate; or that though DENR permits have not been issued, and that while the NRC license is technically issued, it is currently in litigation.**

Response #298:

EPA acknowledges the importance of accurate information. The UIC regulations include specific requirements for information that the UIC applications must include and how EPA should consider this information in developing permit requirements. The UIC regulations also have specific signatory

requirements that include a certification by the applicant that any information submitted is complete, true, and accurate. The certification acknowledges that there are significant penalties for submitting false information. See 40 CFR § 144.32(d). The UIC regulations do not require EPA to obtain additional technical information independently. However, EPA's experts take the information submitted by the applicant and independently review that information, using their expertise and referring to outside sources where applicable and necessary.

EPA disagrees with the commenter that EPA relied on Powertech or other agencies' analyses inappropriately, or that EPA did not conduct independent research adequately. As described in previous responses, not only is it appropriate for EPA to rely on such information from other regulatory agencies such as the NRC and SD DENR under their regulatory authorities, and reach its own conclusions on the basis of such review; the UIC regulations do not require EPA to conduct the analysis itself. Reliance on information that other regulatory entities such as NRC and SD DENR are necessary because these are the entities with jurisdictional authorities over several components of the larger Dewey-Burdock ISR operation. In addition to information that Powertech submitted, and that the NRC and SD DENR analyses provide, EPA also considered other sources of information in the course of its review, as referenced in the CEA.

- 299. Several commenters recommended that the mitigation sections of EPA documents offer a complete and detailed analysis of the required mitigation that is site-specific at the Dewey-Burdock location. Several commenters asserted that EPA's references to mitigation measures lacks adequate specificity and are vague, incomplete, or based on stock language picked from other documents, including:**
- a) discussion of soil impacts mitigation**
  - b) reliance on the future submission and potential issuance of a National Pollution Discharge Elimination Standards ("NPDES") permit to specify mitigation measures and best management practices ("BMPs") to prevent and clean up spills lacks adequate specificity.**
  - c) EPA's generic reference to working BLM mitigation and reclamation guidelines**
  - d) EPA's reference to sound abatement controls.**
  - e) EPA's reference to mitigation of evaporation pond impacts that are and deferred to later analysis under the Clean Air Act's Hazardous Air Pollution provisions.**

Response #299:

EPA determined that the available information contains adequate detail and was appropriate to include in the Cumulative Effects Analysis because it represents the applicant's intent to follow the proposed requirements and mitigation measures, which are under the NRC and the SD DENR's regulatory authorities. The CEA included the most current information regarding the intent of both the State and Powertech with respect to mitigative permit conditions.

- a) EPA acknowledges that the mitigation measures for impacts to soil listed under Section 7.6 on pages 89 through 91 of the CEA are not very detailed; this is because Section 7.6 is a summary of mitigation measures discussed in more detail under Sections 7.1 through 7.5. Section 7.6 also provides references to sections of the proposed South Dakota Large Scale Mine Permit that EPA

reviewed as part of the analysis of impacts to soils for more detail. EPA has changed the incorrect references to Section 7.0 of the CEA under mitigation measures #4 and #5 in Section 7.6 to Section 4.1 Operational Surface Water Monitoring and Stormwater Permitting Requirements and Section 4.2 The Large Scale Mine Permit Water Management and Erosion Control Plan.

- b) In Section 5.8 of the CEA, which provides a summary of prevention and mitigation of potential impacts from spills and leaks, EPA relies on the list Powertech provided in the proposed Large Scale Mine Permit because it is a good summary of the information discussed in more detailed earlier in the section. In analyzing impacts to surface water and impacts from leaks and spills where the UIC Program lacks regulatory authority, it is appropriate for EPA to rely on requirements in South Dakota permits and the regulations where South Dakota has statutory authority to regulate activities at the Dewey-Burdock site. Section 4.0 of the CEA contains many references to South Dakota regulations and sections of the proposed Large Scale Mine Permit that EPA reviewed for evaluating impacts to surface water and wetlands. EPA has added 4.1.2 Stormwater Discharge Permit Requirements to the CEA, which summarizes EPA's review of the construction and industrial general permits that are available on the DENR Stormwater Permitting website. Best Management Practices are proposed for stormwater management and erosion control in general, not just in the context of leaks and spills. Section 4.2 of the CEA provides detailed descriptions of the BMPs Powertech plans to implement under the Stormwater Management Plan. Examples of these BMPs are shown in Large Scale Mine Permit Plates 5.3-6 through 5.3-19, which show the structures that will be used for surface runoff control and erosion control. The CEA provides further detail about the implementation of these BMPs.

Leaks and spills are discussed in the following areas of the CEA:

- 3.3.5 Potential Groundwater Impacts from Spill and Leaks
- 4.6 Potential Surface Water Quality Impacts from Spills and Leaks
- 5.0 Impact from Spills and Leaks

- c) The CEA did not reference existing BLM mitigation and reclamation guidelines. The NRC SEIS references this information.
- d) The CEA did not reference sound abatement controls. The NRC SEIS references this information.
- e) Because the UIC Program does not have regulatory authority over pond construction, it is appropriate to reference 40 CFR part 61, subpart W regulations and defer to the EPA Region 8 Air and Radiation Division for subsequent analysis. The CEA has updated the description of subpart W requirements to be consistent with the final rule. The CEA states that the UIC Area Permits require Powertech to submit information to the EPA Region 8 Air and Radiation Division (Division) to determine the applicability of the subpart W regulations, and if necessary, receive construction approval the Division before EPA will issue an authorization to inject.



**300. A commenter raised concerns with the CEA's discussion on groundwater mitigation where Powertech excluded such mitigation measures from its proposal or merely assumed compliance with applicable requirements.**

Response #300:

It is not clear what groundwater mitigation measures and applicable requirements this comment references. CEA Section 3.5, Summary of Mitigation Measures to Prevent Inyan Kara Groundwater Impacts, references UIC permit requirements and NRC License requirements. It is appropriate for EPA to rely on these requirements. Powertech will be in violation of the UIC Permit or the NRC License if these requirements are not met.

**301. A commenter asserted that the administrative record must not reference a state large scale mine permit. According to the commenter:**

**Wildlife mitigative strategies presented in the Administrative Record are tiered to Powertech's proposed mine permit. EPA must recognize Powertech has only applied for a state mine permit. The proposed state mine permit application has no state standing. Under the SD Mined Land Reclamation Act (SD Codified Law Chapter 45-6b), the Board of Minerals and Environment (BME) is charged with issuing state permits and requirements for ISR facilities. In November of 2013, the BME discontinued hearings on Powertech's proposed state mine permit application until other state and federal agencies finalized their respective permitting. Powertech proposed mine permit application is still pending and no state mine permit exists.**

Response #301:

EPA is mindful that the CEA describes impacts based on draft, rather than final, state permits. The UIC regulations do not prohibit EPA from relying or referencing a state's permit, even if in draft or proposed form. EPA's CEA relies on the most current information regarding the intent of both the State and Powertech with respect to the permit conditions. EPA evaluated this information and determined that the available information contains adequate detail and was appropriate to include in the Cumulative Effects Analysis because it represents the applicant's intent to follow the proposed requirements and mitigation measures, including for the state Large Scale Mining Permit, which is under the SD DENR's regulatory authorities.

As explained above in Responses #292 and #295, if there are changes to the information EPA relied on in finding cumulative effects acceptable, EPA can re-evaluate the cumulative impacts on the environment, and if they are no longer acceptable, EPA can modify the UIC permits. See 40 CFR § 144.39(a)(2). Such a modification would be subject to a public participation process in accordance with 40 CFR § 144.39 and Part 124.

**302. A commenter asserted that plans to account only for a 100-year flood are inadequate and that the plan failed to take into account global warming, mega storms, floods, tornadoes, droughts etc. and raised concern that the plan proposes to stop the flooding**

with a few well placed hay bales and ditches and berms. The commenter referred to Figures 3.4-17 and 3.4-20 which show the open pit mines, the number of well holes and the down gradient and how the ore bodies on the east will flow directly into Pass Creek, and thence to Beaver Creek while the ore bodies on the west side will flow directly into Beaver Creek. The commenter also asserted that in Section 34.5.3.9 Powertech's plans will account only for a 100-year flood.

Another commenter stated that because floods are becoming more destructive and frequent in this area with climate change, adjustments should be made to the "100-year flood" scenario that account for the increased severity and frequency of flooding events. The commenter recommended that additional protections should be put in place for the radioactive settling ponds (and other ponds), land application of wastes, deep disposal wells, catchment areas, and mining structures.

Response #302:

As discussed in Response #289 above, Powertech used three models to evaluate flood impacts on the Beaver Creek drainage. Two of these models produced flood estimates including results for the 100-year, 500-year and an extreme event greater than the 500-year flood event. These results are summarized in Tables 3.5-1 and 3.5-3 of the Proposed Large Scale Mine Permit. Powertech was not able to model the Pass Creek drainage because it is an ephemeral drainage system and there are no United States Geological Survey (USGS) stream gages along Pass Creek drainages to provide data for a model.

As discussed in updated Section 11.2 of the final CEA, EPA evaluated climate change impacts on the increased frequency of high intensity precipitation events in the Dewey-Burdock Area based on information in the [Fourth Climate Change Assessment](#) (2017). As illustrated in CEA Figure 31, the area in southwest South Dakota where the Dewey-Burdock Project Site is located is expected to experience a 0.1 to 0.2 day increase in days with precipitation exceeding 1 inch, which is considered to be a heavy precipitation event.

The commenter referred to Figure 3.4-17 of the Large Scale Mine Proposed Permit, which shows wells for which historical records exist but were not located during Powertech's field reconnaissance of plugged and abandoned wells. The commenter also referred to Figure 3.4-20 of the Large Scale Mine Proposed Permit, which shows wells located upgradient, near, and downgradient of proposed ISR wellfields. The existence of these wells does not indicate that there will be hydraulic connections between the uranium ore bodies and the Pass Creek and Beaver Creek drainage.

Finally while commenters recommended that additional protections be put in place for the radioactive settling ponds (and other ponds), land application of wastes, deep disposal wells, catchment areas, and mining structures, from this list, EPA only has authority under the UIC program to regulate deep disposal wells. The commenters did not provide specifics on the types of additional protections that might be appropriate, nor did they identify concerns with the Class V area permit.

**303. A commenter asserted that there are numerous national research council reports detailing the fact that there are still challenges and technical gaps associated with remediating contaminated groundwater with metals and radon. These technical gaps are**

**not prepared for extreme natural events such as hurricanes, earthquakes, intense rainfall events, and drought and have the potential to lead to the release of contaminants if facilities are not designed and constructed to withstand such events or fail to perform as designed.**

Response #303:

It is not clear what link the commenter is making between groundwater remediation and weather impacts at the surface. The commenter did provide the following citation: *Uranium Mining in Virginia: Scientific, Technical, Environmental, Human Health and Safety, and Regulatory Aspects of Uranium Mining and Processing in Virginia*, in which the webpage for the publication includes the following:

Significant potential environmental risks are associated with extreme natural events and failures in management practices. Extreme natural events (e.g., hurricanes, earthquakes, intense rainfall events, drought) have the potential to lead to the release of contaminants if facilities are not designed and constructed to withstand such events, or fail to perform as designed.

Section 4.0 of the CEA discusses impacts to surface water and wetlands, including impacts from storm events. Section 4.3 discusses Potential Impacts from Floods at the Dewey-Burdock Project. Section 11.2 discusses Local Effects of Climate Change including changes in precipitation at the Dewey-Burdock Project Site.

**304. A commenter states that EPA's CEA discounts the actual risk posed to water quality in the Cheyenne River watershed. The commenter asserts that the CEA fails to calculate the combined impact of the risk posed by the Dewey-Burdock wells with the impoundment of the Cheyenne River at the Bureau of Reclamation Angostura Unit. According to the commenter:**

**Angostura Dam diminishes the water flows of the Cheyenne River on the Pine Ridge Indian Reservation. It interrupts the high spring flows needed for cottonwood regeneration, diminishing the abundance of important plant species used by the Lakota people in ceremonies. Operation of the dam also degrades wildlife habitat on the Pine Ridge Indian Reservation. The return flows from irrigation contain pesticides, heavy metals, and sodium.**

Response #304:

EPA considered cumulative impacts that the project activities will have on surface water and wetlands, including the Cheyenne River. This is discussed in Section 4.0 of the CEA. As stated in Response #239, there will be no surface water impacts from either the Class III or the Class V injectate to the Cheyenne River, the Cheyenne River Indian Reservation, the Pine Ridge Indian Reservation, or other downstream communities. The point source discharges from the project to surface waters will be from construction and industrial stormwater flows and must comply with South Dakota DENR's construction and industrial stormwater NPDES permits. Under Section 402 of the Clean Water Act and its implementing regulations, those permits must ensure that permitted discharges do not cause or contribute to exceedances of South Dakota's surface water quality standards. Under Section 303(c) of the Clean Water Act, water

quality standards must “protect the public health or welfare, enhance the quality of water and serve the purposes of [the Act].” Moreover, those standards reflect EPA’s Section 304(a) national recommended water quality criteria, which themselves reflect the latest scientific knowledge of the identifiable effects on health and welfare of pollutants in water. Therefore, surface water impacts from the Dewey-Burdock Project have no cumulative effects in common with the Angostura Reservoir or Dam.

**305. A commenter states that the continued pollution of the Cheyenne River will continue to impact the Wild Horse Sanctuary and other lands that border the Cheyenne River as well as the town of Edgemont. The commenter stated:**

**Section 5.6.2.1 of the application states that the slope of the permit area is 2 to 6 degrees to the SW. Due to the location of Pass Creek and Beaver Creek, this slope will force any drainage from leaks and spills and land applications of contaminants plus precipitation to flow SW into these creeks and thus to the Cheyenne River and to Angostora, the Pine Ridge and the Missouri River. This is especially true during heavy downpours such as we experienced this summer which created a 4 foot wall of water that derailed dozens of RR cars and the damaging flooding in the Boulder area which released gallons and gallons of contaminants.**

Response #305:

EPA considered cumulative impacts that the project activities will have on surface water and wetlands, including the Cheyenne River as discussed in Section 4.0 of the CEA. Based on considerations in Responses #239 and #304, EPA concludes there will also be no impacts to lands bordering the Cheyenne River from the Dewey Burdock project.

The commenter misinterprets Section 5.6.2.1 of the South Dakota Large Scale Mine Proposed Permit and the risk of drainage into creeks. The slopes described in this section are 0-2 percent slopes in the Beaver Creek drainage area and 0-6 percent slopes in the Pass Creek drainage area, not 2 to 6 degrees to the southwest, as the commenter claims. The document does refer to “2 to 6 degrees to the southwest,” but this describes the dip of the geologic strata in the Dewey-Burdock Project Area, which is unrelated to the surface topography at the site.

In Section 4.3.2 of the CEA, EPA discusses the July 2013 flood that occurred northwest of the unincorporated community of Dewey. EPA compared the topography of the Project Site and surrounding areas with the topography of the area northwest of Dewey where the July 2013 flood occurred. The area northwest of Dewey, where the July 2013 flood occurred, is a narrow valley with a broad, high topographic feature located to the east of the valley. The flood water source area has a broad, high topographic feature with a maximum elevation of 4949 ft. above mean sea level at Twin Buttes. Precipitation falling on this broad, high feature was directed into the narrow valley through tributaries to Beaver Creek that traveled through incised stream channels which did not provide very much area to dissipate the flood water volume and velocity before reaching the railroad. In contrast, the Dewey Area wellfields are located in a broader valley. Although there is a higher elevation topographic feature located to the east of the Dewey-Burdock Project Area, this feature is of a smaller surface area than the high elevation topographic area further north where the flood occurred. Stormwater drainage

from this high topographic feature does not run through narrow, incised channels, but is more dispersed. The Dewey Area ponds and wellfields lie in a wide-open valley that will allow stormwater flowing from the topographic high area to the east to spread out, dissipating flood water flow speed and water depth.

The commenter also references the 2013 floods in the Boulder, Colorado area. The 2013 floods in Colorado are outside the scope of the Dewey-Burdock permitting actions and not relevant to the analysis at this site.

**306. A commenter asserted that EPA CEA needs to assess the additional risk that the Dewey-Burdock project will cause to an already-impaired Cheyenne River watershed. The commenter asserted that the cumulative impact of the risk posed by the injection of waste from in situ Uranium extraction with the degradation and the accumulation of heavy metals and radionuclides caused by the Angostura Unit is necessary. In support of the assertion, the commenter cites to an excerpt from a study by researchers from the S.D. School of Mines and Technology (Sharma, et al), claiming that the study uncovered that uranium and mining waste have contaminated the upper Cheyenne River. According to the commenter, the study also found that contaminants have migrated to Angostura Reservoir, and the active transportation process threatens the Pine Ridge Indian Reservation downstream. As a result, the commenter concludes that the Draft Cumulative Effects Analysis fails to accurately describe the risk posed to the Oglala Sioux Tribe.**

Response #306:

Please see Responses #239, #304 and #305 above for EPA's assessment of impacts to the Cheyenne River.

**307. Commenters stated that the climate change discussion in the CEA does not include information on all fuel and electricity use and the resulting GHG emissions emitted during mining operations and throughout the uranium enrichment process: from exploration; mining; transportation of the raw uranium for processing; enrichment; fuel rod manufacture and installation in nuclear reactors; power generation; decommissioning; and the eventual transport of spent fuel rods for permanent disposal. According to the commenter, these emissions are significant and should be identified at each stage of the production, power generation, and disposal chain and included in the discussion on the cumulative impacts of this project. The commenter notes that while EPA discusses the process, which uses gasoline or diesel and large amounts of electricity—some of which is presumably generated using fossil fuels—it omits the GHGs emitted throughout this process completely.**

Response #307:

Section 11.3 of the CEA summarizes NRC's analysis of three sources of GHGs related to the Dewey-Burdock Project Site. These three sources are: 1) estimated carbon dioxide emissions associated with facility sources (including stationary sources and facility fugitive emissions from the uranium recovery process); 2) mobile sources (i.e., construction and drilling equipment and commuter vehicles); and 3) indirect emissions from electricity consumption (e.g., emissions associated with the production of the electricity that the proposed project consumes). As the CEA notes, the NRC determined in its SEIS that the majority of greenhouse gas emissions from the Dewey-Burdock Project Site will be carbon dioxide. Some methane and nitrous oxide emissions will occur, but chlorofluorocarbon and hydrochlorofluorocarbon greenhouse gas emissions are not expected from the project. The NRC's analysis also assessed the emissions from these three sources for the four phases of the proposed project: construction, operation, aquifer restoration and decommissioning. The peak years are those years when all four phases are occurring simultaneously as shown in Figure 32 of the CEA, and the NRC determined that the annual estimated greenhouse gas emissions for a peak year is 38,621 metric tons (42,572 short tons). For a more detailed breakdown of emissions related to each of these four phases, and as attributed to the three sources, please see the figure in Section 11.3 of the CEA and/or refer to the report prepared by Inter-Mountain Laboratories, Inc., Air Science division (IML), (IML Report) that the CEA cites to.

However, as the commenter correctly points out, the CEA does not quantify potential downstream GHG emissions from later steps in the uranium fuel cycle that are remote in time and distance from the injection wells. The CEA quantifies emissions from yellowcake production in Section 11.3.4. According to the IML report, air impacts from transportation of yellowcake offsite, including GHG emissions, are quantified only for transport on the unpaved roads near the project area. (IML at 6). While EPA describes the subsequent steps in the uranium fuel cycle in Section 11.4, it does not quantify emissions from: transporting yellowcake to the conversion facility beyond the unpaved roads near the Project Site, the emissions resulting from the process of yellowcake to uranium hexafluoride gas, the enrichment process to increase the concentration of uranium-235, nor any other subsequent steps in the uranium fuel cycle up to the end use of the uranium by nuclear power plants. EPA's discussion of cumulative effects of greenhouse gases under 40 CFR § 144.33(c)(3) is limited to those cumulative effects from the construction and operation of additional injection wells. Therefore, environmental impacts that are remote in time from the construction and operation of additional injection wells and/or far away geographically from the wells, such as emissions from the downstream steps in the uranium fuel cycle, are outside the scope of the consideration of cumulative effects required under 40 CFR § 144.33.

**308. A commenter stated that aquifer depletions and water quality impacts from ISL mining should be discussed with climate change impacts.**

Response #308:

The permitting actions' impacts on aquifer depletions and water quality impacts are discussed in detail in several sections of the CEA. Section 3.0 discusses impacts to USDWs, including potential groundwater consumption and water quality impacts on the Inyan Kara and Madison aquifers that may result from the project's operational and decommissioning activities. Section 4.0 discusses impacts to surface water from ISR operations at the Dewey-Burdock Project Site. CEA Section 3.1.1 discusses impacts of groundwater consumption on the Inyan Kara Aquifers; CEA Section 3.1.2 discusses impacts of

groundwater consumption on the Madison aquifer. In the 2017 and 2019 draft CEA documents, these sections referenced Chapter 19 of the Third National Climate Assessment released in 2014 by the U.S Global Change Research Program. Chapter 19 discussed the impacts of climate change in the Great Plains region. According to this report, winter and spring precipitation was projected to increase in the northern states of the Great Plains region, which indicates that the recharge to the Inyan Kara aquifers would not decrease from the recharge values used by the DENR Water Program during evaluation of Powertech's Inyan Kara water rights permit.

To update the final CEA, EPA reviewed Chapter 22 of the Fourth National Climate Assessment, Volume II: Impacts, Risks, and Adaptation in the United States produced by the U.S Global Change Research Program. This chapter discusses the impacts of climate change in the Northern Great Plains region. (Conant, R.T., et al., 2018, *Northern Great Plains*. In *Impacts, Risks, and Adaptation in the United States: Fourth National Climate Assessment, Volume II* [Reidmiller, D.R., C.W. Avery, D.R. Easterling, K.E. Kunkel, K.L.M. Lewis, T.K. Maycock, and B.C. Stewart (eds.)]. U.S. Global Change Research Program, Washington, DC, USA, pp. 941–986. doi: 10.7930/NCA4.2018.CH22). EPA also reviewed Chapter 7, Precipitation Change in the United States, in Climate Science Special Report, Volume I of the Fourth National Climate Assessment (Easterling, D.R., et al., 2017, Precipitation change in the United States. In: Climate Science Special Report: Fourth National Climate Assessment, Volume I [Wuebbles, D.J., D.W. Fahey, K.A. Hibbard, D.J. Dokken, B.C. Stewart, and T.K. Maycock (eds.)]. U.S. Global Change Research Program, Washington, DC, USA, pp. 207-230, doi: 10.7930/J0H993CC). According to information in these reports, winter and spring precipitation is projected to increase in southwestern South Dakota where the Dewey-Burdock Project Site is located. (Conant, R.T., et al., 2018, at 954; Easterling, D.R., et al., 2017, Figures 7.1 and 7.5) Based on this information, the recharge to the Inyan Kara and Madison aquifers will not decrease from the recharge values used by the DENR Water Rights Program during evaluation of Powertech's Inyan Kara and Madison water rights permit.

The CEA provides adequate analysis on aquifer depletions and water quality impacts as part of its climate change assessment of the CEA, and further analysis is not necessary.

**309. A commenter stated that after the CEA section skips several GHG sources, it states that nuclear power plants are “net neutral GHG emitters.” The commenter asserted that the treatment turns the situation on its head in an apparent attempt to justify the use of nuclear power plants.**

Response #309:

The commenter misconstrues the intent of this statement. As indicated in Section 11.5 of the CEA, the statement that EPA considers nuclear power plants to be net neutral GHG emitters was based on EPA guidelines for the GHG reporting rule. These guidelines say that EPA considers only GHG production at the point at which the emissions occur. For power plants, this point would be where the fuel is combusted to produce the electricity. This statement does not express any preference on methods of power generation.

**310. A commenter stated that the climate change discussion minimizes the amount of drawdown in area aquifers as a result of the expected warmer summers and increased evaporation by simply stating that such drawdown will be offset by increased winter and spring precipitation, without providing any measurements or scientific basis.**

Response #310:

EPA disagrees with the commenter's assertion that the climate change discussion minimizes the amount of drawdown in area aquifers. As described in the response above, Section 11.2 of the CEA does not say that the drawdown of the Inyan Kara and Madison aquifers will be offset by greater precipitation. Rather, it cautions that an offset may not occur due to other implications of climate change. This section explains that if spring precipitation occurs only as large-volume, high-velocity surface run-off events, there may not be time for surface infiltration to increase aquifer recharge. An increase in winter snowfall events followed by slow melting are more likely to result in aquifer recharge. However, quick thawing of snow will also result in a large-volume, high-velocity surface run-off event that may not result in increased aquifer recharge. In assessing these impacts on the aquifers, EPA relied on modeling predictions by the US Global Change Research Program's Fourth National Climate Assessment, Chapter 22, which was released in 2017. These modeling predictions projected climate change impacts in the Great Plains region under different modeling scenarios. As described further in Section 11.2 of the CEA, the modeled scenarios are bracketed by a best-case scenario resulting from a projected lower emission of greenhouse gases, identified as the Representative Concentration Pathways (RCPs) 4.5 scenario, and a higher emission scenario identified as the RCP 8.5 scenario, which potentially represents a "worst-case" scenario for climate change impact.

**311. A commenter stated that the cumulative impacts do not adequately consider the proposed project's use of large amounts of water because EPA documents downplay the actual amount of water that would be consumed by this project, or the long-term impacts that this water use could have on the environment and economy of the southwestern Black Hills.**

Response #311:

The CEA provides a discussion of EPA's consideration of water use of the project. Section 3.0 of the CEA discusses EPA's review of Powertech's proposed consumptive use of the Inyan Kara and Madison aquifers, as it relates to the drilling and operations of the injection wells proposed under the UIC area permits.

The UIC regulations specifically require that EPA consider cumulative effects on the environment. See 40 CFR §§ 144.33(c)(3); 144.39(a)(2). Consideration of economic issues is outside the scope of the cumulative effects analysis.

**312. A commenter asserts that for the sections on ground water use in the Draft Cumulative Effects Analysis, EPA should have consulted other people rather than being overly-reliant on the opinion of one person, the former South Dakota State Engineer.**

Response #312:



EPA consulted several sources in order to analyze ground water use for the CEA, one of which was the South Dakota State Engineer, or Chief Engineer. This position resides in the Water Rights Program in the South Dakota Department of Environmental and Natural Resources. This program has expertise on South Dakota water use.

In addition, EPA reviewed information supporting the first two conditions for Powertech's Inyan Kara and Madison water rights permits. The USGS and the South Dakota Geologic Survey have published many studies on aquifers in South Dakota available as references to Water Rights Program staff for aquifer evaluations. The staff reports for the Powertech Inyan Kara and Madison aquifers included a summary of available pertinent information for each aquifer, including a list of references reviewed.

EPA also reviewed additional reports on Inyan Kara and Madison aquifers that are available in the administrative record for EPA final permit decisions. EPA did not find any information to contradict information in the staff reports during the review of documents listed in the administrative record.

The commenter did not submit any other information for EPA's consideration or names of other people to consult with on this issue.

**313. A commenter raised concerns with the potential demand for twice as much water. The commenter explained:**

**Powertech has asked for the water rights for 9000 gallons per minute in South Dakota, although they -- and in places EPA -- minimize this by talking only about bleed rates and water recycling. If the company is successful at the state level, they will have the rights to use 9000 gpm of South Dakota water, regardless of bleed rates or recycling -- they will be able to control and use that much water. If they duplicate that just across the border in Wyoming, what would be the impact? As a federal agency, EPA should certainly be considering cross-boundary issues, especially since Wyoming is also in Region 8.**

Response #313:

EPA is aware that Azarga Uranium owns the mineral rights to the Dewey Terrace property in Wyoming across the state boundary from the Dewey-Burdock Project Site. As discussed above in Response #285, the Dewey Terrace project is outside the scope of the cumulative effects analysis required by 40 CFR § 144.33(c)(3) because these future activities are both too speculative and too remote in time to be included within the scope of the analysis. If in the future, the operation expands to Dewey Terrace, EPA may re-evaluate the Area Permits to determine whether the cumulative impacts of any additional wells are acceptable. This may result in a modification, revocation and/or reissuance of the Area Permits under 40 CFR section 144.39. Such a modification would be subject to a public participation process in accordance with 40 CFR part 124.

EPA discusses the impact of groundwater withdrawal on the aquifers as part of the Cumulative Effects Analysis. The impact to each aquifer is caused by the net withdrawal from each aquifer, not the total flow rate. The impacts of groundwater withdrawal from the Inyan Kara and Madison aquifers are

discussed in Section 3.1 of the CEA. Table 4 of the CEA, which is from Powertech's Inyan Kara water rights application report, shows that Powertech proposed to use a maximum pumping rate for ISR of 8,000 gpm. EPA is aware that this pumping rate is twice the flow rate Powertech proposed in its NRC License application.

**314. Powertech requests correcting typographical errors as follows: "Table 6 is Table 2-1 in Powertech's Report to Accompany Madison Water Right Permit Application shows a different breakout of the maximum estimated Madison usage as shown in Table 5 4. The maximum anticipated Madison usage is one gallon per minute more in Table 65 than in Table 54."**

Response #314:

EPA agrees with Powertech's comment and has corrected the typographical errors related to the description accompanying Tables 5 and 6 in Section 3.1.2 ("Madison aquifer") in the CEA as proposed in this comment.

**315. Powertech raised a comment regarding the following statement in the CEA: "EPA reviewed the information Powertech provided about the potentiometric surface drawdowns of the Inyan Kara Aquifers expected from the maximum gross pumping rate of 8,500 gpm." Powertech stated that since it is the net pumping rate and not the gross pumping rate that affects drawdown, Powertech requests correcting this as follows: "EPA reviewed the information Powertech provided about the potentiometric surface drawdowns of the Inyan Kara Aquifers expected from the maximum net ~~gross~~ pumping rate of 170 ~~8,500~~ gpm Powertech is requesting from the DENR Water Rights Program."**

Response #315:

EPA agrees that the characterization of potentiometric surface drawdowns discussed here in Section 3.2.1 be characterized in a "net" pumping rate, rather than a "gross" pumping rate. EPA also agrees that the net withdrawal that Powertech has requested in the Inyan Kara water rights application is 170 gpm.

**316. Powertech raised a comment regarding the following statement in the CEA: "the potentiometric surface elevations are expected to recover to within one to two feet at the locations of the pumping well after decommissioning of the project" (emphasis added). Powertech asserted that this sentence is inconsistent with the permit application and Section 3.2.1.2 of this document, which correctly states that the elevations are expected to recover within one to two feet after ISR operations end, as opposed to after decommissioning, which may take years after ISR operations end depending on the length of stability monitoring, regulatory approval of successful groundwater restoration, and post-restoration groundwater monitoring, if required. Powertech stated that this comment also applies to the similar statement on the bottom of page 15. Powertech**

**requests changing “after decommissioning of the project” to “after ISR operations” in both instances.**

Response #316:

EPA agrees that the two statements that Powertech refers to in Sections 3.2.1 and 3.2.1.2 and in this comment need to be revised for consistency with the permit application. EPA agrees that the potentiometric surface drawdowns will begin to recover earlier in the ISR life-cycle than “after decommissioning of the project” as stated in the draft CEA. EPA, however, replaced “after decommissioning of the project” for these two sentences in Sections 3.2.1 and 3.2.1.2 with “after the completion of groundwater restoration of the project” rather than “after ISR operations” as proposed by Powertech because the groundwater potentiometric surface will begin to recover in a wellfield once the inward hydraulic is no longer required after the completion of the groundwater restoration phase, rather than at the end of ISR operations.

**317. Powertech raised a comment regarding the statement in the CEA that estimated drawdown of the Madison aquifer at 551 gpm pumping is “86.8 feet at the Dewey-Burdock site.” Powertech requests clarifying that this is the estimated drawdown at the pumping well, not across the project site. Powertech stated that this is correctly stated on page 18, which indicates that the DENR “calculated the drawdown in the Madison aquifer potentiometric surface from the Madison water supply wells to be 86.8 feet at the well locations within the Dewey-Burdock Project Area.”**

Response #317:

EPA agrees with the commenter’s proposed edits and has revised the CEA in Section 3.2.2 to state: “551 gpm from the Madison aquifer...the graphs shows a drawdown of the aquifer water level of 86.8 feet at the well locations within the Dewey-Burdock Project area,” (emphasis added) and have clarified that the drawdown will occur at the well locations, rather than at the Dewey-Burdock site.

**318. A commenter asserts that EPA’s admission in Section 4.7.1 of the CEA (p. 52) that injectate from the Class V wells will mingle with Madison aquifer water and come to the surface at Cascade Springs, about 20 miles away, should result in EPA’s denial of the Class V UIC permit. The commenter notes that while EPA says this will happen “on the scale of 10,000 years” in its CEA, calculations of water movement underground at the site vary widely. According to the commenter, the information presented in the documents indicates that EPA apparently believes that water movement is many times slower than independent estimates, and to remember that the calculations of water movement underground at the Dewey-Burdock site vary widely. The commenter also asserted that information offered by Powertech’s contractor suggests that water movement is many times slower than independent estimates.**

Response #318:

As discussed in Response #120 above, EPA investigated groundwater flow directions in the Minnelusa aquifer at the Dewey-Burdock Project Site and at the springs, such as Cascade Springs, south of the Black Hills. Based on the potentiometric surface contours in Figure G under Response #120

above, the flow path of Class V injectate would be deflected to the south by the Chilson and Cascade anticlines and would have to flow uphill to reach these springs where Minnelusa and Madison groundwater flows to the surface. Therefore, EPA concludes that the Class V injectate will not contaminate the Madison aquifer and will not reach the area where the artesian springs are located.

**319. A commenter stated that there are other wells into the Minnelusa and Madison aquifers to the south and east, over the 20-mile span between the project site and Cascade Springs. The commenter asserts that this admission should negate the entire Class V application.**

Response #319:

As discussed in Response #109 above, USGS Hydrologic Investigations Atlas, Sheet 2 of 2, shows the Minnelusa potentiometric surface around the southern Black Hills. It shows water wells completed in the Minnelusa aquifer around Hot Springs, which is near the Minnelusa outcrop. (Strobel, et al., 2000, Potentiometric Surface of the Minnelusa Aquifer in the Black Hills Area, South Dakota, USGS Hydrologic Investigations Atlas HA-745-C, Sheet 2 of 2.) The map also shows Minnelusa water wells along the Cascade Anticline and one well on the Dudley Anticline, where the Minnelusa aquifer occurs at a shallower depth along the axes of the anticlines. Figure G under Response #120 shows the locations of some of these wells. The Minnelusa formation occurs at a higher elevation in this area than the Minnelusa injection zone at the Dewey-Burdock Project Site. Because the Class V injectate would have to flow uphill/upgradient to reach these wells, EPA concludes that the flow path Class V injectate will be deflected to the south and will not reach this area.

EPA specifically conducted an evaluation of water wells potentially downgradient from the Dewey-Burdock site and found that no water wells were completed in the Minnelusa Formation within about 18 miles downgradient from the site. Based on this evaluation, EPA has determined injection into the Minnelusa Formation at the Dewey Burdock site will not endanger existing water wells.

**320. A commenter asserted that Section 3.3.1 of the Cumulative Effects Analysis (p. 19) is vague on key aspects of the impacts that will occur to ground water quality in the ore zone. The commenter stated that the second-to-last sentence of this section says that the company “will monitor groundwater using standard industry practices.” The commenter noted that this sentence is repeated in the section on post-restoration monitoring (p. 22). The commenter states that these standard practices have been associated with all sorts of problems, including the ongoing failure to return even one ISL mine’s water to baseline. The commenter also states that EPA should provide a better explanation for how EPA defines “minimal” in its statement that EPA “concludes that impacts to ore zone water...should be minimal.” The commenter asks the following: Is it what EPA will allow? Is it minimal to the company? Or is it minimal to the impacted communities?**

Response #320:

As discussed in Response #16 above, EPA does not regulate the ISR wellfield groundwater restoration process or groundwater quality within the Inyan Kara ore zones because these areas are exempted

based on the presence of commercially producible uranium ore. However, EPA reviewed the NRC license and supporting information, which requires Powertech to conduct groundwater restoration within the wellfield injection zone consistent with NRC license requirements described in Section 6.1.3 of the NRC Safety Evaluation Report and Section 2.1.1.1.4 of the SEIS.

As stated in Section 6.1.3.5 of the NRC Safety Evaluation Report, during active aquifer restoration, each wellfield will be monitored on a frequency sufficient to determine the success of aquifer restoration, optimize the efficiency of aquifer restoration, and determine if any areas of the wellfield need additional attention. Based on this information, EPA stated in Section 3.3.1 of the CEA that Powertech will monitor groundwater using standard industry practices to determine the progression and effectiveness of restoration. EPA has determined this description of the groundwater restoration monitoring frequency is accurate. Furthermore, it is the groundwater restoration method, rather than groundwater restoration monitoring frequency, that affects the final concentrations of ISR contaminants in the ore-bearing areas at the completion of groundwater restoration. EPA did not change Section 3.3.1 of the CEA document based on this comment.

Section 3.3.1 of the final CEA discusses potential impacts to ore zone groundwater quality in more detail. The list of potential ISR contaminants included in NRC SEIS Table 7.3-1 Background Water Quality Parameters and Indicators for Operational Groundwater Monitoring is now included as Table 7 of the final CEA. Based on EPA review of constituents at different ISR wellfields in Texas, Wyoming and Nebraska, the constituents for which pre-operational concentrations EPA MCLs were not able to be reached include total dissolved solids, arsenic, boron, cadmium, calcium, fluoride, iron, lead, magnesium, manganese, mercury, potassium, selenium, uranium, radium-226, vanadium and zinc (Cameco Resources, 2018; Hall, 2009; Neupauer, 2010). However, in some ISR wellfields groundwater concentrations of arsenic, cadmium, fluoride, lead, mercury, and radium-226 decreased compared to pre-operational concentrations (Hall, 2009, at 30).

The ISR contaminants for which ACLs may be required in ISR wellfield groundwater depends on the trace minerals present in the ore deposit, the mineralogy of the aquifer unit before ore deposition occurred, and aquifer properties such as porosity and permeability which affect the circulation of groundwater restoration fluids. The metals identified in Dewey-Burdock uranium ore deposits, besides uranium, include vanadium, selenium, molybdenum, iron, calcium and radium-226 (2015 PEA). The presence of pyrite will result in residual iron and sulfate and the presence of calcite will result in residual calcium and carbonate (Johnson, 2012). Based on this information, impacts to the ore zone groundwater at the Dewey-Burdock Project Site may include concentrations of these constituents elevated above pre-operational concentrations.

The pre-operational groundwater quality within Inyan Kara ore zones already includes elevated concentrations of total dissolved solids, sulfate, iron, manganese, gross alpha, radium-226, radon and, in some locations, uranium (EPA, 2020, Memo to file documenting Inyan Kara groundwater quality). The poor groundwater in Inyan Kara ore zones render this groundwater to be unfit for drinking water. Based on pre-operational ore zone groundwater quality, ISR operations will not impact the suitability of ore zone groundwater for use as a source of drinking water. However, there will be small, but presently unknown, impacts from increased concentrations of ISR contaminants for which ACLs are approved by NRC. Therefore, EPA concludes that ISR impacts to ore zone ground water quality after completion of

groundwater restoration will be minimal compared to the pre-operational ore zone groundwater quality.

The CEA discusses the Class III Area Permit requirements, including the requirement that no ISR contaminants may cross the aquifer exemption boundary into the USDW; therefore, there will be no impacts to communities or users of Inyan Kara groundwater outside the aquifer exemption boundary. EPA has updated the CEA to include the information in this response and to clarify the ISR contaminants that may be present in concentrations above pre-operational levels after groundwater restoration.

**321. A commenter disagreed with the statement in Section 3.3.2.1 of the CEA, in which EPA says that an excursion can be left as is, if it is not corrected within 60 days; instead, the company can increase its financial assurance obligation in a manner that is suitable to the NRC (p. 21).**

Response #321:

The commenter is referring to a requirement in the NRC License. The commenter mischaracterizes EPA's reference to the NRC License requirement. Please refer to Section 3.3.2.1 of the CEA, which provides information about this requirement.

**322. A commenter stated that the permit application and the draft area permit are both silent on the issue of reduced groundwater flow in the Fall River and Chilson aquifers downgradient of the mining wellfields. The commenter recommended that a water budget analysis is conducted to estimate reductions in flow and a discussion of groundwater discharge from the Fall River and Chilson aquifers.**

Response #322:

The UIC Program does not have authority to regulate groundwater flow and adjudication of groundwater rights. The South Dakota, DENR Water Rights Program regulates groundwater rights and groundwater consumption in the State of South Dakota.

**323. A commenter stated concern that Powertech is essentially not planning on active treatment as part of the groundwater restoration and that instead they will rely on natural attenuation, which will be assessed by collecting cores and conducting laboratory column testing. The commenter asserted that if the leaching data does not indicate an adequate decrease in ISR contaminants –Powertech will need to submit a treatment plan. The commenter expressed concern about implementing this approach because the leaching data might very well be inconclusive and the time and money required to design and operate a treatment method may be unreasonable.**

Response #323:

NRC License requirement 10.6 requires Powertech to perform groundwater restoration in all ISR wellfields. The commenter refers to requirements for core collection and laboratory testing of core that

were in the first draft Class III Area Permit. These requirements for column leach testing of core were removed from the second draft Class III Area Permit and replaced with requirements for development of conceptual site models and geochemical modeling for each ISR wellfield so this comment is moot.

**324. Powertech referred to the statement in the CEA that: “if any [private Inyan Kara wells] are located close to an ISR wellfield and cause a breach in a confining zone ... Powertech will provide an alternative water source to well owners by installing a Madison water supply well, as discussed in Section 3.2.1.1.” According to Powertech the referenced section discusses two options for replacing a private well: installing a replacement well or alternate water supply such as a pipeline from a Madison well. Powertech asserted that a replacement well would not necessarily be installed in the Madison aquifer; for example, it could be installed in the Sundance/Unkpapa aquifer. Powertech requests updating this discussion for consistency with commitments in the Class III permit application.**

Response #324:

EPA agrees that consistent with the Class III permit application, Powertech’s commitment to provide an alternative water source to well owners in this context would not necessarily be installed in the Madison aquifer. Accordingly, the CEA has revised the sentence in Section 3.1.1: “Powertech will provide an alternative water source to well owners by installing a Madison water supply well, as discussed in Section 3.2.1.1” by striking the reference to “Madison” to refer to a water supply well more generally.

**325. Powertech expressed concern about the following statement: “The NRC license requires Powertech to conduct groundwater restoration to the wellfield injection zone to restore the groundwater to pre-ISR conditions (emphasis added).” Powertech noted that while it would be appropriate to characterize the NRC restoration requirements as consistent with pre-ISR conditions, the requirements in 10 CFR Part 40, Appendix A, Criterion 5B(5) are to restore the water to baseline or an MCL, whichever is higher, or an ACL through the rigorous ACL approval process. Powertech requests correcting this statement as follows:**

**The NRC license requires Powertech to conduct groundwater restoration to the wellfield injection zone to restore the groundwater to meet 10 CFR Part 40, Appendix A, Criterion 5B(5) requirements ~~pre-ISR conditions~~.**

Response #325:

EPA agrees with Powertech’s comment to revise the statement in the CEA and has revised the CEA to correctly characterize the requirement in the NRC license that Powertech will restore groundwater to meet Criterion 5B(5) under the NRC regulations, rather than to “pre-ISR conditions.”

**326. Powertech requests adding to the list of mitigation measures to prevent groundwater impacts the groundwater detection monitoring plan required by NRC License Condition 12.25 (Exhibit 016 at 14-15).**

Response #326:

EPA agrees with Powertech's comment that Section 3.5 Summary of Mitigation Measures to Prevent Groundwater Impacts is missing the groundwater detection monitoring plan (under NRC License Condition 12.25) in its summary. Therefore, EPA added the following statement as bullet #6 in the list of measures:

6. The NRC license requires development of a leak detection monitoring plan specifying the number, locations, and screen depths of groundwater monitoring wells that will be installed around the Burdock area and Dewey area ponds.

**327. A commenter disagreed with EPA's statement in the CEA that "radon-222 itself has very little radiological impact on human health or the environment" (p. 85, Cumulative Effects Analysis) because it both runs counter to common knowledge and to EPA's website on the topic: <https://www.epa.gov/radon/health-risk-radon>. The commenter recommended that the UIC Program conduct a comprehensive, science-based analysis of this issue.**

Response #327:

The commenter has taken the statement about the impacts of radon-222 out of context; the full statement identifies that there are potential impacts and potential exposure pathways. The full statement is: "As a noble gas, radon-222 itself has very little radioactive impact on human health or the environment. Radon-222 has a relatively short half-life (3.8 days) and its decay products are short-lived, alpha emitting, nongaseous radionuclides. These decay products have the potential for radiological impacts to human health and the environment. Potential exposure pathways include ingestion, inhalation, direct exposure, and adsorption." EPA notes also that it has updated this sentence in the CEA to state that the half-life should be 3.8 days rather than 3.2 days.

EPA considered this issue in Section 9.0 of the Cumulative Effects Analysis, which provides a summary of potential radiological impacts evaluated for the NRC Licensing process, including impact from radon. Radon emissions and risks resulting from the impoundments constructed pursuant to 40 CFR part 61, subparts A and W have been evaluated through the regulation development process and have been found to be acceptable if the requirements of subpart W are met. Specifically, unconventional impoundments are required to maintain liquid coverage which attenuates the release of radon from solids that settle to the bottom of the impoundment. Radium in solution and the resulting radon emitted to the atmosphere was evaluated and discussed in the document *EPA Risk Assessment Revision for 40 CFR Part 61 Subpart W: Risk Assessment [Radon Emissions from Operating Mill Tailings – Task 5 – Radon Emission from Evaporation Ponds](#)*. The use of barium compounds to reduce the radium concentration in the pond liquids will reduce the potential for radon emissions to the atmosphere.



**328. A commenter stated that EPA should clarify the following statement in its discussion of the Central Processing Plant where the Cumulative Effects Analysis says both that “ventilations systems will exhaust outside the building” and that there will be “open doorways” on processing buildings (p. 86). The commenter recommends that EPA fully-inform the potential employees that open doorways are nowhere near the exhausts for the safety of workers.**

Response #328:

The CEA includes consideration of this issue at Sections 9.3 and 9.4. For more information on requirements related to worker safety and exposure related to radon, please see condition 10.4 of the NRC License, which includes requirements related to in-plant radiation protection, as well as standard operating procedures that effectuates appropriate radiation safety practices to be followed in accordance with 10 CFR Part 20. Additionally, Section 4.3.3 (“Radon”) of the NRC SEIS provides further detail of NRC’s analysis and conclusion that Powertech’s design of the ventilation system and controls adequately meet NRC standards. Because the section of the CEA that the commenter refers to adequately summarizes the NRC’s review of this information and is sufficiently clear, EPA did not update the CEA.

**329. Several commenters asserted that EPA’s cumulative impacts analysis should include a detailed analysis of potentially leaking abandoned mine impacts on groundwater and surface water. A commenter referred to:(1) the September 2014 two-page announcement from U.S. EPA stating that it has completed a Preliminary Assessment (PA) of the Darrow/Freezeout/Triangle abandoned uranium mines located within the area of the proposed Dewey-Burdock project; and (2) the September 24, 2014 document from Seagull Environmental Technologies captioned as “Preliminary Assessment Report regarding the Darrow/Freezeout/Triangle Uranium Mine Site near Edgemont, South Dakota, EPA ID: SDN000803095.” Attached, labeled Ex. OST-026. According to the commenter:**

**EPA’s analysis must analyze the causation link not just between the unreclaimed surface mines and surface water contamination, but also ground water contamination. These EPA documents raise the issue of a causal link to the contamination of ground water and nearby ground water wells. The lack of analysis of these issues demonstrates a lack of basis for any findings regarding the baseline hydrogeology, and particularly groundwater connectivity issues at the site.**

Response #329:

EPA considered the abandoned uranium mines during evaluation of the area permit and does not anticipate cumulative effects in common with the Dewey Burdock project. Consideration of this issue can be found in the Fact Sheet for the draft Class III Area Permit Section 4.8. However, in order to verify this conclusion and ensure protection of adjacent USDWs, EPA included a requirement for monitoring wells downgradient of the Triangle and Darrow pits to evaluate any impacts from the abandoned uranium mines during ISR operations.

**330. A commenter stated that the CEA must fully analyze and address the impacts and alternatives of creation, storage, and disposal of mill tailings – aka 11e2 Byproduct Material. The commenter explained that permanent disposal of solid 11e2 byproduct material is a central feature of the proposed mining operation and a competent review must include an analysis of the impacts or alternatives to shipment and disposal at White Mesa. According to the commenter the NRC environmental documents confirm that White Mesa lacks a license approval from Utah to accept and dispose of the wastes created by the draft license or other NRC-licensed ISL facilities in the region. The commenter noted, however, that neither NRC’s nor EPA’s analysis includes a review of the impacts such disposition would entail, compares those impacts to other reasonable disposal alternatives, or assesses whether disposal at White Mesa facility can be accomplished in accordance with applicable State and federal requirements.**

Response #330:

EPA’s CEA considers radioactive waste in Sections 3.3.4 through 3.3.4.2 for discussions on how radioactive wastes are dealt with on-site. However, EPA disagrees with the commenter’s assertion that the permanent disposal of solid byproduct waste taken off-site must be considered under 40 CFR § 144.33(c)(3). This provision requires EPA to consider the cumulative effects “of drilling and operation of additional wells.” Therefore, the issues required to be considered are limited to those environmental effects at or near the project site that occur close in time with the drilling and operation of the injection wells. For this reason, while EPA’s draft CEA included a summary of NRC’s information on White Mesa Mill, it was for informational purposes only. Additional analysis on White Mesa Mill or any other potential disposal facilities off the Dewey Burdock site is not required. The potential use of the White Mesa Mill or other facility to dispose of 11e.2 byproduct material is later in time and too far away from the injection wells to be considered as cumulative effects under this regulation.

Additionally, it is EPA’s understanding that Powertech is not required to dispose of the 11e.2 byproduct material at a particular location; therefore, while it is possible they may use White Mesa Mill, it is not yet probable. In response to NRC’s May 19, 2010 and May 28, 2010 Requests for Additional Information (RAIs), Powertech identified the following facilities as possible locations for disposal of Dewey-Burdock 11e.(2) byproduct waste: White Mesa facility near Blanding, UT, Pathfinder Mines Corporation Shirley Basin Facility, the Energy Solutions LLC Clive Disposal Site near Clive, UT and the Waste Control Specialists LLC facility near Andrews, TX in response to RAI TR RAI MI-4(c).

**331. A commenter stated that EPA’s cursory discussion of the disposal of Powertech’s 11e2 material contains no analysis of whether or not Utah law or the Mill owner’s (Energy Fuels) license would allow the interstate transport and disposal of this waste given the history of leaks and violations at the White Mesa facility. The commenter noted that interstate transportation impacts across the Intermountain West are evident, but are dismissed without specific analysis. The commenter also asserted that EPA presents no information on the type of containers that would be required for the shipments to White Mesa and no corresponding information on the moisture content of the solid 11e2 byproduct materials or the anticipated decommissioning wastes.**

Response #331:

As explained in Response #330 above, transportation of waste off-site and final disposal of byproduct material is outside the scope of the cumulative effects analysis required by 40 CFR § 144.33(c)(3).

**332. A commenter asserted the following: You've issued a 151-page draft Cumulative Effects Analysis. I was hoping to see more than seven sentences on tribal concerns. Seven sentences is what was given to the Great Sioux Nation. Dakota Access, Keystone XL, Crow Butte, and Powertech, where is the cumulative effects analysis for all of the permits and aquifer exemptions that have the potential to impact the tribes of the Great Sioux Nation? I don't see your Agency fulfilling any type of trust responsibilities in this regard, and it falls on us to fight. It seems that all we do is fight for our water, for environment, for our survival.**

Response #332:

EPA has given a great amount of consideration to tribal concerns throughout the permitting process for the Dewey Burdock UIC wells. To the extent those concerns are about the cumulative effects on the environment from the additional injection wells, they are discussed in the CEA document. In addition to the CEA document, EPA considered environmental justice issues, National Historic Preservation Act issues, and engaged in an extensive tribal consultation process and an extensive public outreach process. Consideration of all these issues can be found in the administrative record.

The commenter implies that EPA is responsible for a cumulative effects analysis for all permits and aquifer exemptions that have the potential to impact the tribes of the Great Sioux Nation. EPA's obligation to consider cumulative effects is not this broad. The UIC regulation at 40 CFR § 144.33(c)(3) says that in order to be able to issue an area permit, "[t]he cumulative effects of drilling and operation of additional injection wells are considered by the Director during evaluation of the area permit application and are acceptable to the Director." None of the projects listed by the commenter share environmental effects in common with the Dewey Burdock project. Therefore, no further evaluation of those projects is necessary under 40 CFR § 144.33(c)(3).

**333. Powertech commented that the CEA's discussion about traditional subsistence practices such as hunting and wild plant gathering. Powertech suggests mentioning that the entire Dewey-Burdock permit area is either private land or BLM- managed federal land for which no public access roads exist. Therefore, Powertech asserts, there is no plausible use of lands within the proposed permit area for "traditional subsistence practices and the procurement of animals and plants for ritual, ceremonial, medicinal and other traditional needs." Powertech requests the addition of text to indicate that there is no public access to lands within the proposed permit area.**

Response #333:

The commenter is referring to a section that was formerly in the 2017 CEA, but that was superseded by the CEA issued for public comment in 2019 that removed this section (formerly 14.3 Tribal Concerns

about Impacts to Vegetation). Therefore, this comment is now moot and no updates have been made to the CEA.

**334. A commenter states that the CEA must include a thorough discussion of how the problem of wildfire impacts would be dealt with to protect the land, air, and water because wildfires are a common problem in the area, and the CEA omits this discussion. According to the commenter there have been at least three large wildfires in the area in the last five years. The commenter asserted that Crow Butte ISL mine - only about 65 miles from Dewey-Burdock--was evacuated in 2012 due to a wildfire. The commenter also noted that impacts on water, air, and land could be enormous, if a building containing nuclear materials, wellfields, or storage ponds were impacted by a wildfire.**

Response #334:

EPA considered the following information on wildfire impacts and has included it in the final CEA. In the proposed Large Scale Mine Permit submitted to South Dakota DENR, Powertech commits to the following plans to minimize impacts if any wildfires occur within the Dewey-Burdock Project Area. Powertech plans to remove vegetation around all facility buildings and cover the ground surface with crushed aggregate or asphalt. Powertech will maintain a vegetation-free state using appropriate weed-control measures. Powertech also plans to maintain a large enough buffer zone to act as a firebreak and prevent fire from damaging equipment that could lead to a chemical release.

Within the ISR wellfields, Powertech will control vegetation around each header house and around each well head cover to reduce the amount of combustible material adjacent to these structures. In the event of an approaching wildfire, operators will be trained to shut down wellfield operations and, if necessary, to evacuate facilities until the danger to personnel has passed. Damage, if any, will be assessed and remediated prior to re-starting operations.

Powertech plans to maintain firefighting equipment on site and provide training for local emergency response personnel in the specific hazards present within the Project Area.

The emergency response plan under the Occupational Safety and Health Administration regulations that Powertech must develop will include descriptions of the following as required under 29 CFR part 1910:

- Notification and evacuation procedures
- Personal protective equipment
- General firefighting safety rules
- Reporting procedures
- Electrical and gas emergencies

Trees are present in isolated areas but relatively sparse, greatly reducing chances of uncontrollable wildfire. The base map for Class III Permit Application Plate 3.1 is a topographic map which identifies tree cover as light green areas. As discussed in Section 3.6.1.1 of the NRC SEIS, trees cover about 23% of the Project Area along the portions of the Beaver Creek and Pass Creek drainages and on higher elevation hilltops. Based on EPA review of Plate 3.1 and aerial views from Google maps, there is no tree cover near the Burdock area central processing plant or the Dewey area satellite plant. There is sparse

tree cover near Dewey Wellfield 1 and Burdock Wellfields 9 and 10. There is sparse tree cover within portions of Burdock Wellfields 4, 5, 6, 7, 8 and 9.

**335. A commenter asserts that EPA’s statement that in 10,000 years the Minnelusa formation’s water will be uncontaminated at Cascade Springs, lacks a reference or study in support. The commenter also asserts that if impacts are to be considered 10,000 years from now, the well documented half-lives of relevant radionuclides and their impacts should certainly be a featured topic in the cumulative effects discussion.**

Response #335:

EPA stated in the CEA that the travel time for Class V injectate to reach the vicinity of Cascade Springs, based on the a general estimation of Minnelusa groundwater travel time would be on the scale of 10,000 years in order to provide a concept of the time scale involved. EPA has conducted a more in-depth analysis of the travel path of Minnelusa groundwater from the Dewey-Burdock site to the vicinity of Cascade Springs and has determined that the Class V injectate at the Dewey-Burdock Project Area will not reach Cascade Springs. As discussed in Response #120 above, EPA investigated groundwater flow directions in the Minnelusa aquifer at the Dewey-Burdock Project Site and at the springs, such as Cascade Springs, south of the Black Hills. Based on the Minnelusa potentiometric surface contours in Figure G, the flow path of Class V injectate would be deflected to the south by the Chilson and Cascade anticlines and would have to flow uphill to reach Cascade Springs where Minnelusa and Madison groundwater flows to the surface. Section 4.7.1 of the CEA has been updated with this information.

**336. A commenter requests clarification of the length of time that the proposed Dewey-Burdock project would be active, and that the draft permits and Cumulative Effects Analysis discuss the full range of potential impacts and scenarios accordingly. The commenter notes that the estimate in the proposed State Mining Permit is seven to 20 years of uranium recovery, maybe more, with the Central Processing Plant likely to operate longer. The commenter also notes that the Class III draft permit is for the “operating life of the facility” (p. 7). According to the commenter, 14 wellfields, each operating for two years, this could be as long as 28 years, if the company ran them consecutively. The commenter notes also that there is also the potential for the company to expand the project to include its contiguous claims to either the east or west of the current project area, and that there’s a difference between regulating a project that lasts seven years and regulating a project that lasts over 20 years.**

Response #336:

The Class III Permit Application includes the project timeline in Figure W showing an estimated life of the project to be 14 years. Not all 14 wellfields will be in operation at the same time, because Powertech plans to initiate wellfield phases (construction, operation, restoration, closure and decommissioning) sequentially for each wellfield. Figure X shows an example of this sequential approach for Burdock Wellfields 1 through 10.

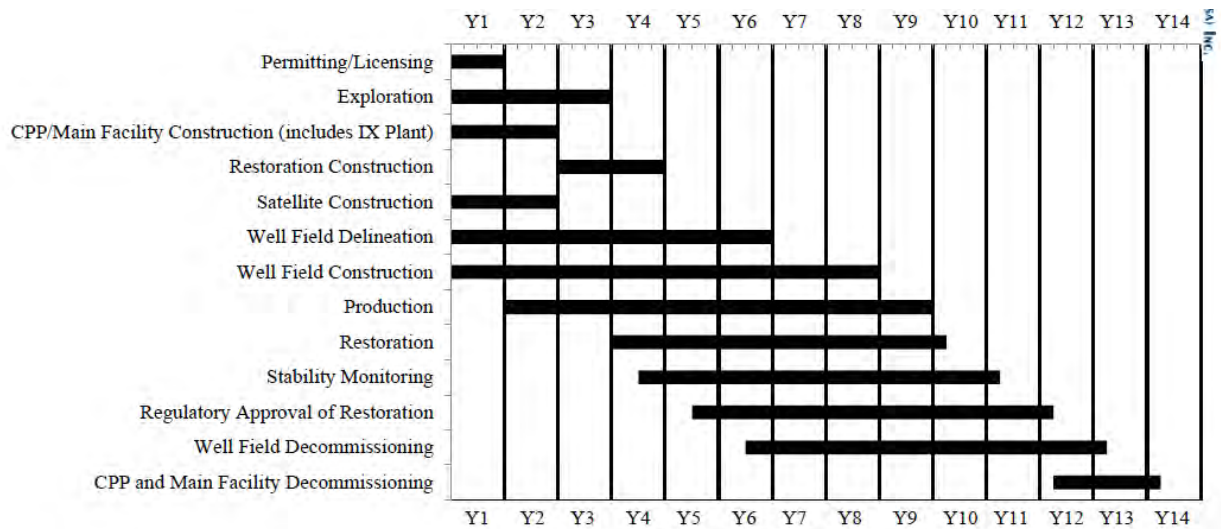

**Figure W Projected Construction, Operation and Decommissioning Schedule (Source: Figure 10.2 in the Class III Permit Application.**

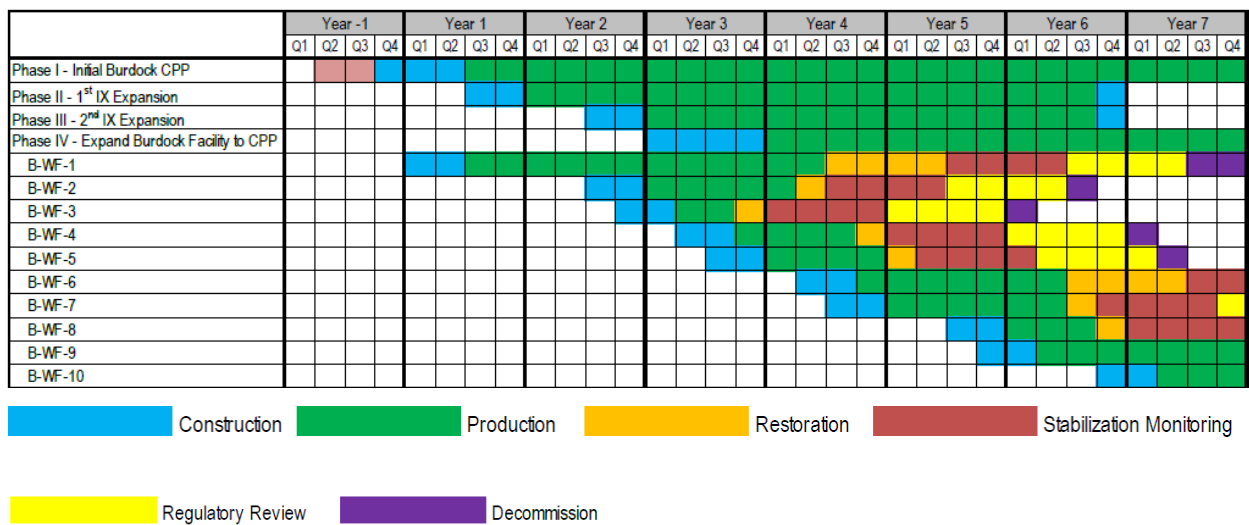

**Figure X. Life of Mine Schedule (Figure 1.3 from the 2015 Preliminary Economic Assessment. (Source: Graves and Cutler, 2015)**

Although the Class III Area Permit has been issued for the life of the project, if Powertech proposes additional wellfields, the company must apply for a major permit modification, which will trigger an updated CEA that will address additional wellfields and the extended project life. A major permit modification will also require another public comment period. Conducting an analysis before that time would be based on speculation instead of actual data. The Class V Area Permit expires after 10 years. Renewal of the Class V Area Permit will provide another opportunity for public comment and an updated CEA. By the time a Class V permit renewal or Class III permit modification occurs, operational information should be available on the amount of time actually needed for each wellfield phases to better inform the life of the project.

**337. Powertech raised a comment regarding the statement in the CEA that Powertech expects to install 4,000 injection and production wells. Powertech requested reference to comment #E1 in Table 3, which describes how Powertech currently estimates that approximately 1,461 injection wells and 869 production wells will be required over the life of the project.**

Response #337:

EPA agrees that the CEA needs to be updated to reflect consistency with the Class III permit. Therefore, EPA has updated the CEA by replacing “Powertech currently estimates that approximate 4,000 injection and production wells” with “Powertech expects to install approximately 1,461 injection wells and 869 production wells over the life of the project.”

**338. A commenter asserts that questions remain on the rate of pumping water during the mining process, and thus further research and analysis is needed before further action is taken on the proposed project. The commenter refers to Section 5.2.1 of the Draft Cumulative Effects Analysis, where the text says that the “header piping [would be] designed to accommodate injection and production flow rates of 2,000 gpm....” (p. 56). The commenter refers to the next page where the document says that there would be 100 wells per header house. According to the commenter, the schedule for the project indicates that as many as five wellfields will be active at one time. The commenter notes that as each wellfield is likely to have more than 100 wells, these numbers add up to more than the 8,500 gpm that the company has asked to use in its more recent documents.**

Response #338:

The ISR wellfields will not be operational at the same time. EPA performed a more detailed flow rate analysis that takes into account when wellfields become active and are closed. Please see the spreadsheet entitled ProjectFlowRates.xlsx that is included as part of the administrative record.

**339. A commenter asserted that the Draft Cumulative Effects Analysis extends well beyond EPA’s regulatory requirement under 40 CFR § 144.33(c)(3), since many aspects do not relate to drilling and operation of the Class III or V injection wells. The commenter also asserts that EPA’s cumulative effects analysis represents a duplication of the NRC’s previous efforts of an already-completed NEPA assessment for the project as documented in the supplemental environmental impact statement. The commenter further explained: while Powertech believes such a cumulative impact analysis should not be a part of these draft permit documents, comments are included in [the] event EPA decides to further pursue this analysis and, in such an event, the following comments should be considered. The commenter also asserted that NRC has already completed a NEPA assessment for the project, documented in the supplemental environmental impact statement (Exhibit 008), which EPA has already reviewed and provided comments.**

Response #339:

EPA's obligation to consider cumulative effects can be found at 40 CFR § 144.33(c)(3). As discussed in other responses, this regulation directs EPA to evaluate the cumulative effects of the drilling and operation of additional injection wells included under the UIC area permits. This obligation is separate from NRC's NEPA obligation. While EPA reviewed NRC's SEIS and other sources of information on cumulative effects, EPA must independently consider these effects during evaluation of the application and make its own determination about whether effects are acceptable in order to meet the obligation under 40 CFR § 144.33.

Importantly, the regulation requires EPA to consider the *cumulative effects on the environment* from the drilling and operation of additional injection wells. See 40 CFR §§ 144.33(c)(3); 144.39(a)(2). Therefore, as described in previous responses, EPA has considered a broad array of impacts that the Area Permit activities (construction, operation, and decommissioning) will have on various media including on air, water (groundwater and surface water), and soil. Nothing in the regulation prohibits EPA from considering information on environmental effects, and EPA maintains discretion on the information it deems necessary to consider.

**340. Powertech requested that EPA update the discussion in the CEA on Powertech's compliance with subpart W of the Clean Air Act, based on the final rule on subpart W that EPA issued in 2017, and Powertech's 2014 commitment to modify impoundment designs to comply with the final rule. Powertech noted that for example, Section 1.0 (Executive Summary) of the draft CEA states that "Powertech's current design for the treatment and storage of ISR waste fluids do not appear to meet the requirements under Clean Air Act regulations found out 40 CFR part 61, subpart W." The commenter requests that EPA update the discussion on compliance with subpart W considering the final rule that was issued in January 2017 and Powertech's November 2014 commitments to modify impoundment designs to comply with the final rule.**

Response #340:

EPA has updated the cumulative impact analysis to include the updated final rule requirements for subpart W which no longer include a limitation on the number of ponds or acreage for unconventional impoundments. As for Powertech's November 2014 commitments to modify impoundment designs, EPA will evaluate the applicability and compliance with subpart W requirements for the impoundment designs when an application for construction has been submitted. EPA did not update the CEA to include the information in Powertech's November 2014 letter.

**341. Powertech requests updating the statement that "EPA is considering revisions to 40 CFR Part 61, subpart W" in light of the final rule release in January 2017. Powertech also suggested updating the discussion to reflect the provisions in the final rule, especially that there are no longer maximum size limits or maximum number of impoundments for non-conventional impoundments such as would be constructed at the Dewey-Burdock Project. Powertech requests clarifying for the public the determination in the final rule that radon**



emissions from non-conventional impoundments that maintain a minimum liquid level are nearly indistinguishable from background. According to Powertech since Powertech will treat the wastewater to remove radium and its byproducts, radon emissions from treated water storage ponds will be minimal. Powertech also requests updating the discussion to recognize its November 2014 commitments regarding modifications to the pond designs to comply with final subpart W provisions (Powertech 2014; Exhibit 032). In response to a request from EPA staff, Powertech committed to modifying the single-lined wastewater storage and treatment impoundments in the Burdock area to minimize the potential for contamination to reach alluvial groundwater. That letter also documents NRC staff's determination that the existing pond designs are adequately protective of human health and the environment and the NRC license conditions related to pond leak detection monitoring, routine pond inspections and development of a standard operating procedure (SOP) for potential pond releases. In addition, Powertech requests that EPA document Powertech's commitment in its November 2014 letter to submit an application to EPA for approval to construct wastewater storage and treatment impoundments at least 60 days prior to construction of the impoundments.

**Powertech explains that this application was not submitted previously to EPA due to the risk that it would further delay the UIC permitting process, which has already taken more than 8 years yet is incomplete, and due to the uncertainty in the provisions of the final subpart W rule, which was not released until January 2017.**

Response #341:

EPA has updated the cumulative effects analysis to include the updated final rule requirements for subpart W which no longer include a limitation on the number of ponds or acreage for unconventional impoundments. Radon emissions from these ponds is generated from solid tailings that settle to the bottom of the pond which is effectively minimized by maintaining fluid coverage. In addition, radon emissions are generated by dissolved radium in the solutions that are within the water column overlying the solids in the ponds. The radon flux is dependent on the radium concentration within the solution as well as the ambient temperature and wind speed. Whether or not radon emissions will be expected to be indistinguishable from the background concentration is uncertain at this time. EPA will evaluate the applicability and compliance with subpart W requirements for the ponds and pond liners when an application for construction has been submitted.

EPA clarifies that in the case of the Dewey-Burdock ponds, the solids at the bottom will not be tailings but the barium-radium compound generated by the barium chloride treatment process removing radium from the waste fluids.

EPA notes that Powertech's November 2014 letter is in the administrative record but did not find it necessary to discuss in the CEA since the Permits require Powertech to submit information to EPA to determine applicability of CAA subpart W prior to receiving an authorization to inject.

**342. Powertech raises a comment regarding the following statement: that "Powertech will use a phased approach to wellfield development beginning with wellfield 1 in the Dewey**

and Burdock Areas.” The commenter referred to a previous comment which describes how this statement is inconsistent with Section 10.10 (p. 10-13) of the Class III permit application, which states that Powertech may develop either the Burdock or Dewey area wellfields first, followed by those in the other area. Powertech’s current plans include developing Burdock area wellfields prior to those in the Dewey area (Exhibit 026). The commenter also noted that this comment also applies to a similar statement on page 70. Powertech requests updating the text on p. 48 as follows:

**Powertech will use a phased approach to wellfield development beginning with wellfield 1 in the Dewey and Burdock Areas. ~~The Burdock B-WF1 wellfield and Dewey D-WF1 wellfield will be constructed during the initial construction phase of the project.~~ Alternately, Powertech may develop either the Burdock or Dewey wellfields first, followed by those in the other area.**

Similarly, Powertech requests updating the text on p. 70 as follows:

**Powertech anticipates that the initial construction of processing facilities, infrastructure (e.g., pipelines, access roads, power lines, and storage ponds), and the two initial wellfields is expected to be completed within two years. Powertech will develop the wellfields in a progressive manner, beginning with Dewey and Burdock wellfields #1. Alternately, Powertech may develop the wellfields and processing facilities in either the Dewey or Burdock area first, followed by those in the other area.**

Response #342:

EPA agrees with Powertech’s proposed revisions and has revised the text in the CEA in the two locations that Powertech describes in its comment. The phased approach that Powertech describes was not immediately clear based on the permit applications. EPA appreciates the clarification provided regarding development of the wellfields in a progressive manner.

**343. Powertech raised a comment regarding the statement in the CEA that “The Class III injection, production and monitoring wells will have casing screen.” Powertech explained that as described under comment #29 in Table 1, Section 11.2 of the Class III permit application specifies that the well screen assembly and filter sand may or may not be used. The commenter noted that the omission of well screen and filter sand would only be done where the screened interval was sufficiently competent; therefore, there would be no impacts to geology with or without the well screen. Powertech requests deleting this sentence.**

Response #343:

EPA agrees with Powertech’s comment to delete the sentence, “The additional casing and cement will not impact the geology beyond the extent of the well bore” because as the commenter points out, the

language in the Class III permit has been updated. The CEA has therefore been updated for consistency with this Class III permit update regarding the well screen.

**344. Powertech raised a comment regarding the statement in the CEA that “Because the Dewey Road is a county road, presumably it is maintained by Custer and Fall River Counties.” Powertech asserts that these counties do maintain their respective portions of the Dewey Road. Powertech also stated that moreover, Powertech executed an agreement with Fall River County to provide equipment, materials, and/or financial assistance to cover a portion of the total road maintenance cost for Fall River County roads used by Powertech during construction and operation (Powertech 2007; Exhibit 038). Powertech requests revision of the text to reflect this commitment.**

Response #344:

EPA agrees with Powertech’s comment and has updated the CEA to delete “presumably” in the sentence that commenter refers to because as commenter explains, the Counties will maintain Dewey Road.

**345. Powertech asserts that the statement in the CEA that "EPA is proposing approval of the aquifer exemption for Burdock wellfields 6 and 7 after well 16, which is a former drinking water well completed in the proposed aquifer exemption area, is plugged and abandoned" is not correct. Powertech notes that there are now three approaches in the Revised Draft Class III Permit and Aquifer exemption record of decision to address this. Powertech adds that as noted in E-14, Powertech believes that as written option three provides a reasonable and suitable approach to address well 16. Powertech requests that this statement be updated accordingly.**

Response #345:

EPA is not approving the exemption of Inyan Kara aquifers in the area of Burdock Wellfields 6, 7 and 8, which also includes the location of well 16. Therefore, this comment is moot. (See #23 under *Changes to the Class III Area Permit* and the Aquifer Exemption Record of Decision for explanation of this decision.)

EPA agrees that the CEA should be updated to be consistent with the final Aquifer Exemption Record of Decision. EPA has updated the CEA accordingly.

**346. Powertech raises comments regarding two statements in the CEA: "The header house components will be connected to programmable logic controllers that send data to the control systems components will be connected to programmable logic controllers that send data to the control systems," and the statement that "In addition, the flow rate of each production and injection well will be measured automatically. Measurements will be collected and transmitted to both the Central Processing Plant and Satellite Facility control systems." Powertech asserts that these statements are inconsistent with the permit**

**application and the Revised Draft Class III Permit which says flows will be recorded daily (Part VIII. F.4.b.iii.).**

Response #346:

EPA agrees with Powertech's comment that flow rates will be transmitted to both the Central Processing Plant and Satellite Facility control systems, and that such flows will be recorded daily. EPA has made updates accordingly in Section 5.2.4 of the CEA.

**347. A commenter raised concerns about erosion as well as concerns about statements in Powertech's proposed Large Scale Mine Permit: that Section 5.3.9.2 states only that erosion of disturbed areas will be minimized. According to the commenter, there are three problems with this assurance: a) Powertech's admission of the disturbed areas in the first place; b) that they will not try to prevent any erosion outside of the disturbed areas only minimize the erosion inside the disturbed areas; and c) the admission that they will not even attempt to repair the erosion to its original state. The commenter asserts that public health is not served by this cavalier attitude towards runoff prevention. The commenter also adds that Section 5.3.4.4 of the Large Scale Mine Permit states that "all grades will provide for natural runoff" which as we have seen only further guarantees the flowing of contamination into the creeks and rivers.**

Response #347:

The commenter is referring to sections of South Dakota's draft Large Scale Mine Permit. Section 5.3.9.2 discusses Powertech's plan for erosion control. The commenter included only a portion of the information from this section of the permit. The first paragraph of Section 5.3.4.4 states:

Powertech (USA) will minimize erosion of disturbed, reclaimed and native areas through proper land management and farming techniques. Typically, following ground disturbance, areas will be prepared and seeded as soon as possible to reduce the possibility of erosion. Also, erosion control measures will be used to reduce overland flow velocity, reduce runoff volume or trap sediment. Examples include rip-rap, vegetative sediment filters, check dams, mulches, cover crops, and other measures. Plates 5.3-6 through 5.3-8 show the sediment control measures that will be used in the permit area.

As described in Section 7.0 of the Cumulative Effects Analysis, the greatest impacts to soils will occur during the construction phase, primarily from earthmoving activities during construction of ISR surface facilities, roads, wellfields, and pipelines. The Permittee will be required, under Section 5.6.2 of South Dakota's proposed Large Scale Mine Permit, to implement mitigation measures to limit potential soil erosion impacts. Potential soil impacts during the ISR and aquifer restoration phases may result from pipeline leaks (which are not covered under the UIC permits); these would be mitigated by routine monitoring and mandated spill reporting and recovery actions. The decommissioning phase will impact soils in a manner similar to that of the construction phase. Therefore, EPA has concluded, based on a review of information in South Dakota's proposed Large Scale Mine Permit and the NRC's SEIS, that there will be no long-term impact to soils. Section 4.2 of the CEA discusses South Dakota's Large Scale Mine Permit Water Management and Erosion Control Plan in more detail.

The commenter also refers to Section 5.3.4.4 of South Dakota's proposed Large Scale Mine Permit, which is about pond construction. The statement being referenced is:

*Finishing: Finished grades shall slope uniformly between given spot and contour elevations. All grades shall provide for natural runoff of water without low spots or pockets.*

The statement refers to grading for natural runoff for the purpose of preventing low spots that would collect stormwater as opposed to directing stormwater flow from the pond area. As discussed in Section 5.6 of the CEA, Powertech plans to construct control structures, such as collector ditches and berms around the ponds, to direct stormwater overland flow away from the ponds.

**348. Powertech states that in the paragraph above Section 10.4.1, the statement is made that "The peak year accounts for the time when all four ISR project life-cycle phases (construction, operations, aquifer restoration, and decommissioning) are occurring simultaneously and represents the highest amount of emissions the project will generate in any one year." According to Powertech, if post-restoration groundwater monitoring is required for this project, it would delay decommissioning by many years if not decades, such that the decommissioning phase would not overlap with any of the other project phases. Powertech states that therefore, this worst-case scenario would not occur. Powertech requests updating this discussion if post-restoration groundwater monitoring is required.**

Response #348:

Post-restoration groundwater monitoring is no longer required; therefore this comment is moot, and no update in the CEA is needed. The discussion that the commenter refers to describes NRC's analysis of the impacts on air quality during the peak year to evaluate the maximum impacts to air quality. The peak year accounts for the time when all four ISR project life-cycle phases (construction, operations, aquifer restoration, and decommissioning) are occurring simultaneously and represents the highest amount of emissions the project will generate in any one year. EPA notes that decommissioning had a small impact compared to sources that were projected to have the greatest impact. The estimates are a reasonable worst case scenario which is appropriate for inclusion regardless of whether decommissioning would actually be delayed. (See Responses #64 and #68 for a discussion of the requirements that replaced the post-restoration groundwater monitoring in the Class III Area Permit.)

**349. Powertech raises a comment regarding the statement, "the NRC ... did not use the most recent regulatory-approved version of the [AERMOD and CALPUFF] model software platforms." According to Powertech, the AERMOD version used by IML Air Science (IML) in the project modeling was updated by IML's software vendor, Lakes Environmental, multiple times after the original modeling protocol was developed. Powertech asserted that as a practical matter, any model version is likely to be out of date by the time an EIS is published. According to Powertech this is particularly true when follow-up model runs are required. Powertech also stated that the important consideration is that the versions of AERMOD and its associated software tools were current and mutually compatible when**

**the model was implemented, and that to preserve comparability the model was not changed mid-stream. Powertech requests updating the discussion to document that the versions of AERMOD and its associated software tools were current and mutually compatible when the model was implemented.**

Response #349:

EPA agrees with Powertech's comment. There was initially a typographical error with regard to the version of AERMOD used by Inter-Mountain Laboratories, Inc. (IML) and noted by EPA in our 4/17/2013 comments for the EIS modeling analysis. Responses to our comments and the IML report (IML 2013a provided as Exhibit 033) indicate that AERMOD version 12345 was used for the modeling analysis. For CALPUFF, the IML 2013a report indicates that the regulatory model (version 5.8) was used for the modeling analysis. EPA has updated the CEA by deleting the following phrase "did not use the most recent regulatory-approved version of the model software platforms" in Section 10.4.1.

**350. Powertech raises a comment regarding the statement in the CEA that "EPA did not find that NCR [sic] provided sufficient information to support the use of dry depletion in the AERMOD analysis." According to Powertech precedent has been established by state and federal agencies for using the dry depletion option in AERMOD to model short-term impacts from fugitive dust emissions. Powertech notes for example that a coal lease application in Utah triggered PM10 modeling that included a refined analysis using deposition and plume depletion (IML 2013; Exhibit 033). Powertech notes that Page 9 of Appendix K in the Alton Coal Lease DEIS states, "deposition was only considered for assessing the final PM10 modeled ambient air impacts. Deposition was not considered for any other pollutants ..." Powertech also refers to P. 10 of the same document which states "the primary pollutants of concern are fugitive dust." (BLM 2015; Exhibit 034).**

**Powertech asserts that the Colorado Department of Public Health and Environment (CDPHE) uses dry depletion to model PM10 impacts from fugitive dust sources at mining facilities seeking air quality construction permits (IML 2013; Exhibit 033).**

**Powertech notes also that recent projects for which this option was used include the Lafarge Gypsum Ranch Pit, Oxbow Mining's Elk Creek Mine, and Bowie Resources' Bowie N.2 Mine. Powertech also asserts that the Wyoming Department of Environmental Quality stated that it would accept the use of plume depletion algorithms in AERMOD as long as an applicant justifies the inputs, including particle size, particle density and mass fraction (IML 2013; Exhibit 033). Powertech adds that both Colorado and Wyoming operate EPA-approved air permitting and enforcement programs.**

**Finally, Powertech asserts that a recent modeling analysis was triggered by high fugitive dust impacts in the Salt River area of Arizona. Maricopa County was reclassified as a serious PM10 nonattainment area on June 10, 1996. According to Powertech the primary sources of particulate pollution in this area are "fugitive dust from construction sites, agricultural fields, unpaved parking lots and roads, disturbed vacant lots and paved roads"**

**(IML 2013; Exhibit 033). Powertech adds that cited among the “general characteristics that make AERMOD suitable for application in the Salt River Study area” is the claim that “gravitational settling and dry deposition are handled well.” Powertech requests that EPA update this discussion in light of the evidence presented in this comment.**

Response #350:

While the commenter provides examples of cases that used dry deposition, these cases have no relevance to EPA concerns related to the modeling conducted for this action. Consistent with Section 7.2.7(b) of Appendix W of 40 CFR part 51 (hereafter referred to as “Appendix W”), gravitational settling and deposition may be directly included in a model if either is a significant problem and when particulate matter sources can be sufficiently quantified. In other words, dry deposition/depletion may be utilized in AERMOD as long as the particle size distribution is known reasonably well for each source and sufficient data is available to develop the required inputs for this configuration option (i.e., particle diameter and density and mass fraction). EPA did not find that sufficient information was provided to support the approach used to apply dry deposition. In particular, dry deposition was not applied to only PM10 sources associated with fugitive dust emissions. Instead, dry deposition was applied to all PM sources (PM2.5 and PM10). Therefore, AERMOD was not configured in a manner consistent with EPA’s modeling guidelines.

**351. Powertech raises a comment regarding the statement in the CEA that “The dry depletion option may be appropriate to use in AERMOD when sufficient data are available to determine the particle size distribution and other particle information reasonably well for each source.” Powertech asserts that sufficient justification was provided in the IML 2013 modeling (Exhibit 033), as summarized below:**

**The original PM10 particle size distribution was obtained from the modeling protocol for the Rosemont Mine in Arizona (IML 2013; Exhibit 033). The modelers for the Rosemont project acquired this distribution from AP-42 Section 13.2.4 and applied it to fugitive dust emissions from haul roads. Because Section 13.2.4 applies to aggregate handling and storage piles, other sources were consulted to validate the use of this particle size distribution for haul road dust. A study by Watson, Chow and Pace referenced in a New Jersey Department of Environmental Protection report found that 52.3% of the particulate from road and soil dust is less than 10 µm in diameter. Of this particulate 10.7% was found to be smaller than 2.5 µm in diameter and the remaining 41.6% fell between 10 and 2.5 µm. Assuming that fugitive dust particle sizes follow a lognormal distribution, these two data points were transformed into a multi-point particle size distribution for comparison to the original particle size distribution. The geometric mass mean diameter for the original distribution is 6.47 µm, while the mean diameter for the lognormal distribution is 5.76 µm. EPA’s AP-42 Section 13.2.2 and supporting studies characterize PM30 from unpaved road dust (the dominant source at Dewey-Burdock) as 30.6% PM10 and 3.06% PM2.5. Again, assuming a lognormal particle size distribution, the mean diameter would be 6.77 µm. CDPHE has approved a mean coarse particle diameter for road dust of 6.25 µm (Trinity 2016;**

Exhibit 035). Since these values are clustered around the original PM10 size distribution, it was retained for both CALPUFF and AERMOD dry deposition modeling.

As stated above, the mass mean diameter of PM10 particles with the chosen size distribution referenced above is 6.47  $\mu\text{m}$ , or approximately 65% of the top diameter. Applying this ratio would yield about 1.5  $\mu\text{m}$  for the mean PM2.5 particle size. Hence, the choice of 1  $\mu\text{m}$  mean particle size diameter for PM2.5 was conservative in that it increases atmospheric entrainment and decreases settling. In contrast to PM10 modeling, the plume depletion option had only a minor effect on modeled PM2.5 impacts. Aluminosilicate clay minerals that characterize soil dust in the project area typically have particle density near 2.65 g/cm<sup>3</sup>. As indicated in IML's final report (IML 2013; Exhibit 033), the Environmental Science Division of Argonne National Lab states, "A typical value of 2.65 g/cm<sup>3</sup> has been suggested to characterize the soil particle density of a general mineral soil. Aluminosilicate clay minerals have particle density variations in the same range." Another study of fugitive dust from unpaved road surfaces, by Watson and Chow, also cites 2.65 g/cm<sup>3</sup> for soil particle density (IML 2013; Exhibit 033). In a more recent analysis, the CDPHE-approved particle density for road dust is 2.655 g/cm<sup>3</sup> (Trinity 2016; Exhibit 035).

**Powertech requests that EPA update this discussion in light of the evidence presented in this comment.**

Response #351:

Although a rationale was presented with regard to particle size, EPA's concerns were not focused on particle density, diameters and distribution. EPA had concerns with other aspects of the approach used to apply dry deposition that did not align with EPA's modeling guidelines (Appendix W). In particular, dry deposition was not applied to only PM10 sources associated with fugitive dust emissions. Instead, dry deposition was applied to all PM sources (PM2.5 and PM10). Therefore, AERMOD was not configured in a manner consistent with EPA's modeling guidelines. Sufficient information was not provided to support the approach applied by the commenters. As for the second part of the comment that is focused on IML's choice for PM2.5 size used in dry depletion modeling and the request that we update the discussion regarding particle density assumptions made by CDPHE, EPA will not change the analysis discussion because our concerns related to the configuration of AERMOD still remains outstanding.

**352. Powertech raises a comment regarding the statement in the CEA that "dry depletion should have been applied to all receptors within the model domain." Powertech notes that using the dry depletion option, IML modeled all receptors with predicted 24-hour PM10 impacts in the initial modeling run that, when added to background, were greater than the NAAQS of 150  $\mu\text{g}/\text{m}^3$ . According to Powertech this threshold was chosen to demonstrate ultimate compliance of all initially high receptors. Powertech also explains:**

**the regulatory default settings were used to screen potential problem receptors, and the dry depletion option was used to refine the model results only for those receptors. Since**



**the dry depletion option has the effect of reducing (never increasing) predicted impacts, it was deemed unnecessary to apply this option to receptors already demonstrated to be below the NAAQS threshold. The predicted concentrations would only have decreased beyond those obtained under the regulatory default option.**

**Powertech requests that EPA update this discussion in light of the evidence presented in this comment.**

Response #352:

EPA modeling guidelines should be followed for the configuration of dry deposition in AERMOD. In reassessing the necessity of a consistent receptor network between the simulations with and without dry depletion, the refined receptor network for the simulation with dry depletion could have been acceptable. However, EPA continues to have concerns with the simulation with dry depletion because it was applied to all sources. Instead, dry depletion should have only been applied to those sources associated with fugitive dust emissions to ensure that the impacts associated to PM10 are predicted properly. Therefore, AERMOD was not configured in a manner consistent with EPA's modeling guidelines.

**353. Powertech refers to the following statement in the CEA: "the approach used by NRC will not account for the diesel engine exhaust PM10 particles that will not settle out as quickly as the mechanically generated fugitive dust emissions." According to Powertech most of the non-fugitive sources of particulate emissions at Dewey-Burdock are diesel engines. Powertech states that EPA is correct that some error may be introduced by including combustion sources of PM10 in the dry depletion runs. Powertech explains that most particulate matter in diesel exhaust falls within the PM2.5 category and exhibits a much slower deposition rate than PM10. Nonetheless, Powertech asserts, fugitive sources are dominant at Dewey-Burdock, where diesel exhaust constitutes only 1% of the total PM10 emissions. Powertech states that for this reason, and to avoid further complicating the final model run, IML grouped all PM10 sources together. Powertech requests that EPA update this discussion in light of the evidence presented in this comment.**

Response #353:

Combustion related PM<sub>10</sub> emissions should not have been included in the simulations with dry deposition or excluded from the CALPUFF runs. However, EPA updated Section 10.4.1 by adding the following clarification sentence: "The emission inventory showed small PM<sub>10</sub> emissions from combustion relative to inventoried dust emissions. However, these emissions should not have been excluded from the CALPUFF modeling. The effect that this had on the reported impacts is uncertain without remodeling according to Appendix W guidelines."

**354. Powertech raised a comment in regard to the following statement that describes the 24-hour PM10 modeling results that the IML and NRC analysis presented: "the top 3 values are of interest regardless of when they occurred." According to Powertech, for compliance demonstration, the standard design value is the 4th high concentration over a**

**3-year period. Powertech stated that this value is shown in Table 6-1 (IML 2013; Exhibit 033) and should not be confused with the yearly statistics also presented in that table. Powertech requests that EPA update this discussion in light of the evidence presented in this comment.**

Response #354:

The results presented in the IML and NRC analyses, and as explained in the CEA, do explain and present the 24-hour PM10 model results in the correct form of the standard, as well as additional model results for informational purposes. No response or change is needed because the presentation of additional model results (i.e., model results that are not presented in the form of the standard) does not impact the results of the analysis.

**355. Powertech raised a comment regarding the statement made in Section 10.4.2.4 Visibility Analysis Results: “IML and NRC determined there is evidence and precedent that supports excluding ground-level, fugitive PM10 emissions from the assessment of project impacts on visibility at Wind Cave ... However, EPA did not support this approach for the SEIS.” Powertech noted: as stated in the final report (IML 2013; Exhibit 033) and acknowledged by EPA, even without excluding coarse particulates, the 98th percentile of the annual 24-hour average changes in haze index is less than the contribution threshold of 0.5 dv. Powertech added, “still, IML conducted a final model run excluding coarse PM10 for several reasons:**

- CALPUFF predicted that 70% of visibility impairment at Wind Cave from the Dewey-Burdock Project was caused by coarse PM10. This goes against visibility modeling results obtained by various agencies including South Dakota DENR. Aerosols of sulfate and nitrate, organic carbon, and fine particulates (PM2.5) are generally the significant contributors to visibility impairment.**
- To test the reasonableness of the modeled impact of coarse particulates on visibility at Wind Cave, IML used CALPUFF to model the impact of PM10 coarse emissions from Dewey-Burdock at three test receptors (IML 2013; Exhibit 033). The receptors were placed 40, 80, and 116 km from the project, respectively. CALPUFF predicted higher relative contribution from coarse PM10 as the distance from the project to the receptor increased. This outcome defies common sense and exposes the fallacy of modeling visibility without accounting for near-field deposition of coarse PM10.**
- Notwithstanding EPA’s challenge to the evidence and precedent appearing in the final report, the modeling protocol does cite NEPA precedent for excluding fugitive dust emissions from visibility impact modeling. This approach was followed in the Atlantic Rim EIS (IML 2013; Exhibit 033), which cited supporting documentation from the Western Regional Air Partnership (WRAP).**
- A 2005 study (VISTAS 2005; Exhibit 036 at p. 3-13) states, “PM2.5 particles, which have a mass median diameter around 0.5 μm, have an average net deposition velocity of about 1 cm/minute ... On the other hand, coarse particles ... have an average deposition velocity**

**of about 1 m/minute, which is significant, even for emissions from elevated stacks.” It seems unreasonable to model the long-range transport of both species as if they behaved the same.**

**Regarding exclusion of coarse particulates from stationary sources: It should be noted that stationary sources at Dewey-Burdock are combustion sources with negligible emissions compared to mobile sources and fugitive dust sources. Moreover, particulates from stationary combustion sources are 97% PM2.5 (IML 2013; Exhibit 033) and were already accounted for since only coarse PM10 was omitted from the final visibility model run. Powertech requests that EPA update this discussion in light of the evidence presented in this comment.”**

Response #355:

Sufficient information has not been provided to update the discussion, both in regard to the removal of coarse particulate from the CALPUFF modeling, and also in regard to Powertech’s assertion that excluding stationary source coarse PM10 emissions is appropriate because these emissions are a small subset of the total PM emitted by stationary sources, which is mostly PM2.5. Stationary source coarse PM10 emissions should be included in the simulations, as well as coarse PM10 from other sources that could contribute to impacts at adjacent Class I areas. The commenter’s assertion that coarse particulate does not travel far is inaccurate. There are documented studies that show PM10 with a lifetime of at least a week and can transport distances into other states and countries. Additionally, the cumulative effects analysis indicates that the 98% percentile impacts with course particulate matter using the conservative analysis was not of concern even when the emissions were included in the simulations.

**356. Powertech asserts that the last sentence in this section appears incomplete: “If Powertech does not implement one or more of these measures properly ...”**

Response #356:

This comment has already been addressed with revisions that were incorporated into Section 10.6 of the CEA that was issued in 2019 which completed this sentence with the following: “If Powertech does not implement one or more of these measures properly (especially measure 3 which is expected to result in a 60% or better reduction in emissions generated from onsite unpaved roads), then the director may no longer find that cumulative effects are acceptable.”

**357. Powertech raises a comment regarding the statement in the CEA that “the Dewey-Burdock project has not been shown to greatly effect [sic] regional cumulative air quality.” According to Powertech this should be expected, given the comparison between project emission levels and regional emissions. Powertech notes that since fugitive PM10 emissions from Dewey-Burdock constitute the largest single pollutant, and since EPA’s analysis takes issue with the degree of conservatism in modeling fugitive PM10 impacts on air quality and visibility, the following table may lend some perspective:**

Area Encompassed	Fugitive Emission Sector(s)	PM <sub>10</sub> Emissions (tons/year)
State of Wyoming	Unpaved Road Dust	421,044
State of Wyoming	Mining Dust	93,331
State of Wyoming	Crops and Livestock Dust	39,112
State of South Dakota	Crops and Livestock Dust	333,119
State of South Dakota	Unpaved Road Dust	77,273
Dewey-Burdock Permit Area and County Road	All Fugitive Dust Sources (max. year)	458

[Source: EPA 2017; Exhibit 037]

**Powertech further explains that since Wyoming is situated generally upwind from Wind Cave National Park, fugitive dust from this state may be more relevant than dust from South Dakota. Powertech also states that projected maximum fugitive PM10 emissions from Dewey-Burdock represent 0.08% of the emissions from Wyoming’s three largest sectors, and 0.11% of the emissions from South Dakota’s two largest sectors. Powertech requests that EPA update this discussion in light of the evidence presented in this comment.**

Response #357:

The statewide emissions data and assertion that Wyoming is generally upwind of Class I areas in South Dakota does not provide meaningful insight into which sources might contribute to impacts within the South Dakota Class I areas. This assertion would further support EPA’s recommendation that coarse PM10 should be included in modeling. The best information available to determine the potential impacts from a source that has not yet been constructed is the use of modeling. While regional Wyoming emissions may also contribute to impacts at locations assessed by the modeling conducted for Dewey Burdock, these impacts were not assessed by the NRC EIS but would be captured by the existing monitoring networks within the states. These existing impacts are accounted for in the Dewey Burdock modeling analysis by adding modeled impacts to the background concentrations that were found most appropriate for the region, as well as explained for other metrics within the existing conditions section of the NRC EIS. EPA cannot present conclusions on the level of impacts predicted for Dewey Burdock as compared to the level of impacts that could be caused by statewide Wyoming emissions sources based on emission inventory data alone. Therefore, the request by the commenter does not change EPA’s conclusion and does not provide meaningful insight that would benefit the analysis. No change is necessary to the CEA.

**358. Powertech notes that in the first paragraph of Section 11.3.1, Estimated CO2 Emissions from Electrical Power Consumption, the CEA states that “the year one facility construction does not appear to be distinguishable in the estimation of CO2 emissions related to electrical power consumption during the construction phase.” Powertech notes that the GHG emissions from year 1 construction amount to about 0.2% of the cumulative, project GHG emissions. According to Powertech, however, most of the electricity consumed during the Dewey- Burdock construction phase will be for facilities construction, where utility power will be available. Powertech further states that wellfield**

**construction will involve primarily mobile and earth-moving equipment to drill wells and install piping and power lines. Powertech also states that electricity use in the wellfields will correspond mainly to the operations phase. Powertech requests that EPA update this discussion in light of the evidence presented in this comment.**

Response #358:

EPA re-evaluated the GHG emissions during the first year of construction and determined that the 542 metric tons of CO<sub>2</sub> per year is applicable only to the first year and is attributable to electrical power consumption during construction of facilities other than wellfields. EPA has updated CEA Table 32 to reflect this change. Similarly, EPA has determined that Powertech accounted for all GHG emissions attributable to electrical consumption during the decommissioning of facilities other than wellfields during the last year and has updated total estimated CO<sub>2</sub> emissions calculated for the life of the project in Table 36 accordingly.

**359. Powertech asserts that it appears that metric tons and short tons are switched in several rows (i.e., those where the metric tons are higher than the short tons) in Table 34 of the CEA. Powertech recommends correcting these tables.**

Response #359:

EPA agrees that several values in Table 33 regarding “Total Estimated CO<sub>2</sub> Emissions Calculated for the Life of the Project,” needed to be updated. EPA made updates to Table 33 in the CEA where short tons and metric tons values were switched the previous table.

**360. Powertech asserted that in the fourth paragraph of Section 11.4 of the CEA, Uranium Processing, the statement is made that the NRC SEIS does not include any information about GHG emissions during the uranium enrichment phase. The commenter asserts that enrichment is downstream from the Dewey-Burdock Project. The commenter noted also that IML considered the analysis of this phase beyond the scope of the SEIS just as it did the analysis of an ultimate use for the enriched uranium (i.e., nuclear power plants). According to the commenter, EPA acknowledges, and many studies support the net reduction in life-cycle GHG emissions achieved by nuclear power when it displaces fossil fuel power. The commenter further adds that “notably, the GHG reporting rule does not include uranium enrichment facilities or nuclear power plants among the 41 industrial sectors required to report. Powertech requests that EPA update this discussion in light of the evidence presented in this comment.”**

Response #360:

As described in Response #307 above, neither the NRC SEIS nor the CEA assesses information about GHG emissions from the uranium conversion process. As the commenter notes, EPA states in Section 11.5, Nuclear Power Plant Operation, that the GHG reporting rule under 40 CFR part 98 does not include uranium enrichment facilities or nuclear power plants amongst the sectors required to report GHG emissions. EPA did not update this section of the CEA as it already adequately describes the Greenhouse Gas Reporting Rule for purposes of the CEA.

361. Powertech raises a comment regarding the statement in the CEA that Powertech proposes to store, use, and receive shipments of anhydrous ammonia (NH<sub>3</sub>). According to Powertech, it does not propose to use ammonia at the Dewey-Burdock Project. Powertech refers to Figure 3.2-6 in the approved NRC license application and explains that it shows that sodium hydroxide will be used in the precipitation circuit instead. Powertech also refers to Table 3.2-1 in the approved NRC license application, which lists the process-related chemicals and quantities planned for the project, likewise does not include ammonia. Powertech requests removing mention of anhydrous ammonia from this paragraph.

Response #361:

EPA agrees with Powertech’s comment and has updated the two references to “anhydrous ammonia” (NH<sub>3</sub>) in the CEA Section 12.2, and instead replaced them with sodium hydroxide. We have included Figure 3.2-6 in the approved license application here.

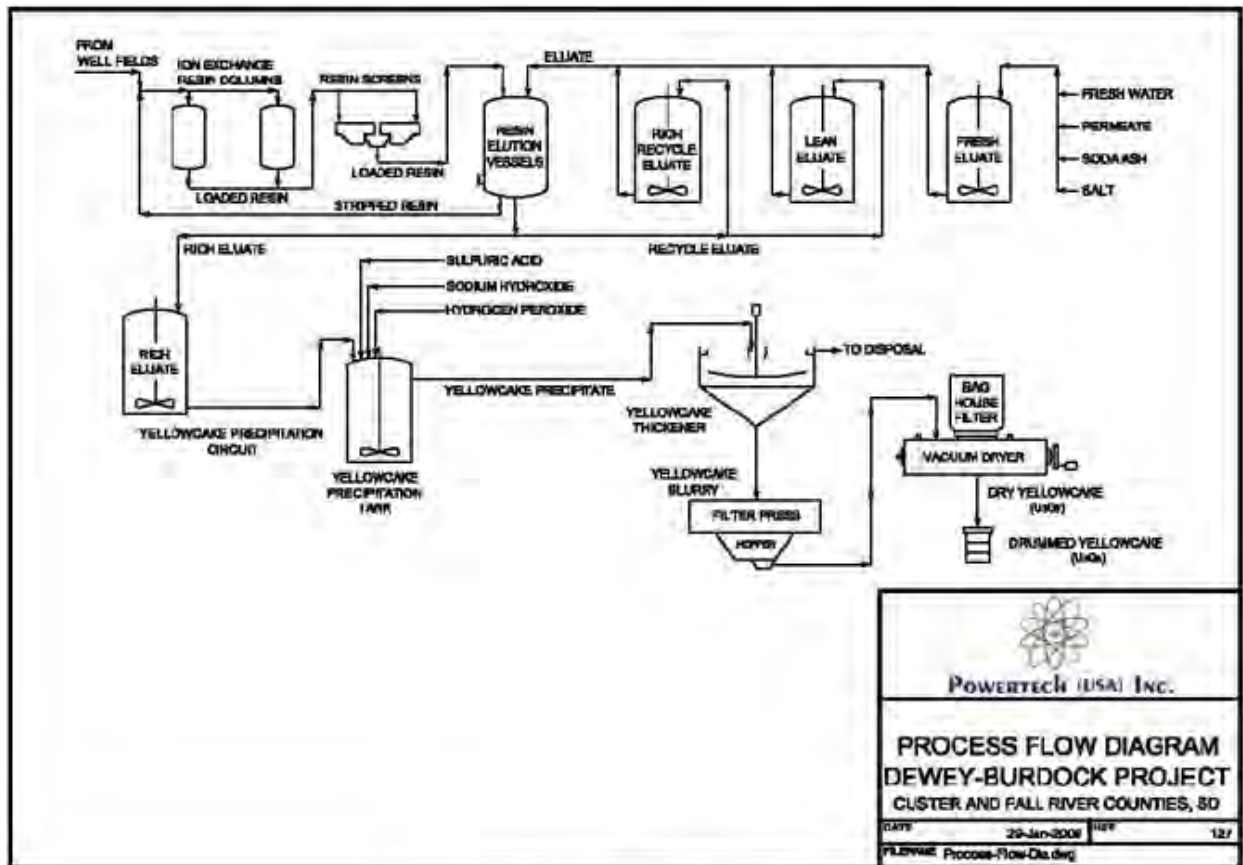

Figure 3.2-6: Overall Process Flow Diagram

362. Powertech raises a comment regarding the statement in the CEA that “To mitigate impacts from spills and leaks and to prevent long term impacts, the DENR NPDES permit will require Powertech to develop an Emergency Preparedness Program under the project Environmental Management Plan.” Powertech requests correcting this statement to

**reflect that the Environmental Management Plan is a requirement of the NRC license rather than the DENR NPDES permit. Powertech notes that this comment also applies to similar statements on pages 62, 67 and 74.**

Response #362:

EPA agrees with the clarification that the proposed DENR Large Scale Mine Permit requires Powertech to develop an Emergency Preparedness Program, while the NRC license requires development of an Environmental Management Plan as referenced in the Technical Report included in the License application. Therefore, EPA has made changes in the CEA accordingly to reflect these respective requirements.

**363. A commenter asserted that the extent and effectiveness of the avian mitigation plan that is identified in the administrative record cannot be substantiated because the management plan is conceptual, has not undergone agency review, and essentially does not exist. The commenter further stated:**

**The Dewey Burdock Project proposes a plan to mitigate impacts to avian species during operations, however, special emphasis is given to bald eagles. Monitoring wells, a processing plant, production well fields, disposal facilities, and a supply water well are all currently proposed within a buffer established for an active bald eagle nest. During the life of the project, seasonal restrictions and unspecified mitigative measures are proposed for the facilities. The Administrative Record does not analyze the viability of seasonal mitigation measures on continuously operated facilities. Analysis also does not consider the questionable effectiveness of seasonal mitigation during times of urgent maintenance or situations requiring emergency repairs on continuously operated facilities. Mitigation measures also rely on individual eagle tolerance; as tolerance is known to vary greatly among individuals. Unsuccessful mitigation risks a disturbance take. Analysis in the administrative record does not recognize the necessity of bald eagle take permitting.**

Response #363:

The commenter is referring to the avian mitigation plan that is described in Section 14.4 of the CEA, Proposed Mitigation Measures in the DENR Large Scale Mine Permit. As the commenter states, the DENR Large Scale Mine Permit has not yet been finalized. However, the state's proposed permit and the avian mitigation plan that it includes is under the purview of the state DENR. As described previously, EPA concluded the potential impacts of the SDWA actions on ecological resources, including avian species, are acceptable, based on: its review of information that Powertech has submitted to date and the requirements Powertech has to comply with under South Dakota law for a large scale mine permit as described in Section 14.3 of the CEA. As for the commenter's assertion about a potential eagle taking, as EPA describes in further detail in Response #365 below, Federal agencies acting in their regulatory capacities, including under the SDWA, are not subject to the prohibitions of the Migratory Bird Treaty Act (MBTA) or the Bald and Golden Eagle Protection Act (BGEPA).

**364. A commenter stated that the administrative record fails to recognize or establish the relationship between the site’s prairie dog colonies and avian management. The commenter stated, “in other words, it does not describe the project’s direct and cumulative effects on prairie dog colonies, and collateral impacts on bald eagles and other avian species.” The commenter noted that the site’s prairie dog colonies are the presumed forage base and home range for bald eagles and other avian species.**

Response #364:

As described previously, EPA considered the potential impacts of the SDWA actions on ecological resources, including avian species and the prey they may rely on, and concluded that these impacts are acceptable, based on: its review of information that Powertech has submitted to date and the requirements Powertech has to comply with under South Dakota law for a Large Scale Mine Permit as described in Section 14.3 of the CEA.

**365. A commenter stated that the administrative record does not assess the reasonable risk of a bald eagle disturbance take during project operation given the operation of UIC permits in an important bald eagle habitat area, and the uncertainty associated with a seasonal mitigation strategy for a continuously operated facility. The commenter states that authorization of UIC activities on the site provides a reasonable risk of an unpermitted bald eagle disturbance take. According to the commenter, seasonal mitigation is the discernible method of nesting bald eagle protection but USFWS take permitting is done "only" if necessary. The commenter also stated that obtaining a permit out of necessity implies a response to a situation that may already have constituted disturbance or take.**

**Another commenter stated that a Fish and Wildlife Service (“FWS”) raptor monitoring and mitigation plan has not been developed despite confirmed raptor activity in the project area. The commenter also stated that the FWS permits to avoid and mitigate impacts to Bald Eagles’ use of three existing Bald Eagle nests are vague and inadequately referenced.**

Response #365:

Federal agencies acting in their regulatory capacities are not subject to the prohibitions of the MBTA or the BGEPA. See, 80 Fed. Reg. 30032, 30035 (May 15, 2015) and 74 Fed. Reg. 44,843 (Sep. 11, 2009). See also, Protect Our Communities Foundation v. Jewell, 825 F.3d 571, 585 (9th Cir. 2016). Thus, the Region is not subject to the Migratory Bird Treaty Act (MBTA) or the Bald and Golden Eagle Protection Act (BGEPA) take provisions in its issuance of the SDWA permits and aquifer exemption approval to Powertech, a third party. Powertech, however, may be subject to the requirements of these statutes.

EPA is not familiar with the FWS’s raptor monitoring and mitigation plan or the FWS permits that the commenter refers to. This comment appears to be more appropriately directed to the FWS.



**366. A commenter asserted that Section 14.2 of the CEA, "Species of State and Tribal Interest: The Short-Horned Lizard" does not describe all species of state interest and provided the following link for a complete listing of state threatened, endangered or rare species: [http://gfp.sd.gov/wild life/threatened-endangered/](http://gfp.sd.gov/wild%20life/threatened-endangered/). P. 355**

Response #366:

EPA's intent in Section 14.2 of a previous draft of the CEA which described the short-horned lizard, was to address a comment raised during the public hearing process and was not to assess all state-listed or threatened species in detail. This section on the short-horned lizard has now been deleted from the CEA. Instead, and as explained in previous responses above, Section 14.3 of the CEA now describes EPA's review of information that Powertech has submitted to date and EPA's review of the required state process prior to issuance of a Large Scale Mining Permit, and provides further detail explaining that based on this review, EPA finds potential impacts to ecological resources, including species of state interest, to be acceptable.

**367. A commenter asserted that species other than animals are not considered in this discussion. The commenter stated, "[p]lants cannot simply move off the site. Some of them are important to tribal practices and customs, such as medicinal plants and timsila (prairie turnips). Full scientific information should be gathered, and full analysis must be done, for non-animal species. Species that are important to the long-term residents of the area -- the Lakota, Cheyenne, and other native nations -- require special protection." The commenter recommended that there is already information on protection of some species in project documents that could serve as a base for part of this analysis, but that, a full and independent analysis is also needed.**

Response #367:

Section 14.4 of the CEA summarizes the proposed DENR Large Scale Mine Permit's (LSMP) measures to avoid or mitigate potential impacts to ecological resources at the site. Under the proposed LSMP, Powertech will be required to conduct a vegetative survey before the mining operation, as part the requirement to develop a reclamation plan. SDCL 45-6B-7(3); see also Section 5.6.11.2 of the proposed DENR Large Scale Mine Permit. The reclamation plan must also include a description of how the reclamation plan will rehabilitate the affected land, including vegetation. SDCL 45-6B-7(7). Further, if Powertech ultimately uses the land application method of disposal, Powertech is required to conduct a site evaluation to determine compatibility of the solution with the site vegetation. EPA understands that there may be particular plant species that are especially important to tribal practices and customs. If these plants occur in the disturbed areas within the Dewey-Burdock Project Boundary, they will be lost, but only from those areas. During EPA's evaluation of potential ESA impacts, EPA confirmed there are no threatened or endangered plant species in the project area. Given that any plants of concern in the project area are not listed as threatened or endangered, EPA does not expect that this limited impact will jeopardize these plant populations as a whole. EPA further notes that as discussed in Response #243, within the Project Area, the land is privately-owned and any plant gathering activities could not occur without permission from the land owner. Based on EPA's review of information that Powertech has submitted to date and the requirements Powertech has to comply with under South Dakota law for a Large Scale Mine Permit as described in Section 14.3 of the CEA, EPA disagrees with the commenter that the CEA needs further analysis beyond what is currently provided.

**368. A commenter asserted that EPA’s assessment of wildlife must include careful consideration of an October 17, 2008, letter written by Stan Michals of South Dakota Department of Game, Fish and Parks. The commenter adds that Michals letter said that exploratory activity should not take place on some parts of the project area between February and August (inclusive) due to the presence of a bald eagle nest (a state-protected bird) and a redtail hawk nest. The commenter concluded that therefore, mining, deep disposal wells, land application, and reclamation, which are more long-lasting and disruptive than exploration, should clearly also not take place during those seven months of the year in raptor nesting and other protected areas.**

Response #368:

EPA appreciates the letter that Mr. Michals from the South Dakota Department of Game, Fish, and Parks has submitted regarding concerns related to the nests of a bald eagle and redtail hawk. In evaluating the effects that the permitting actions would have on ESA species, EPA (in consultation with U.S. FWS), was mindful of the potential effects to listed ESA species during certain phases of the permitted activities. For example, based on EPA’s Biological Assessment, in the event that construction is planned during the whooping crane and rufa red knot migration seasons or the northern long-eared bat active season, the Class III and Class V area permits require Powertech to have a qualified biologist conduct pre-construction surveys for these species and training for workers to assist with the identification of all listed species during construction and operation. This process must occur five days prior to the initiation of any construction activities. While directed toward the ESA-listed species, these measures will benefit other migratory birds to address the specific concerns that the commenter raises.

**369. A commenter asserted that the sturgeon chub must be included in the discussion of wildlife concerns. The commenter stated that the sturgeon chub “is present in the Cheyenne River and may be threatened or endangered in areas downstream from the proposed mine. Additional silt, heavy metals, and radioactive materials would be potential threats.”**

Response #369:

As stated in previous responses (#304 and #305), EPA considered cumulative impacts that the project activities will have on surface water and wetlands, including the Cheyenne River. Section 4.1 of the CEA discusses the operational surface monitoring required by the NRC License and the DENR proposed Large Scale Mine Permit, which includes monitoring for suspended solids, metals of concern and radionuclides. This section also discusses the stormwater discharge permits Powertech will be required to obtain for construction and industrial activities. To comply with these permits Powertech must control erosion to prevent sediment from leaving the site and meet water quality standards discussed in Response #304 above. Based on the water quality standards Powertech will be required to meet for surface water discharges from the site, EPA concludes there will be no impacts to wildlife that inhabit the River, such as the sturgeon chub.

**370. A commenter asserted that ongoing development of mitigation plans for ESA-listed species are vague and inadequately referenced.**

Response #370:

Section 14.2 of the CEA includes a detailed summary of the Biological Assessment's mitigation measures that the Class III and Class V permits incorporate in order to avoid, mitigate, or minimize any impacts on three ESA-listed species that EPA, in consultation with U.S. FWS, have found may be present inside the project area. As this is merely a summary, should the commenter seek more detailed information, please refer to Class III Area Permit Part XIV, Section B; Class V Area Permit Part IX, Section B.

**371. A commenter asserted that EPA's SDWA duties independently trigger compliance with federal wildlife laws, such as the MBTA, before any decisions can be issued on Powertech's application. The commenter stated:**

**NRC's FSEIS reveals that active bald eagle and other raptor nests are known to exist in and near the proposed project site. FSEIS at 4-147, accord at 3-46 ("Five confirmed, intact raptor nests and one potential nest site were observed within the proposed project area, and the applicant identified two additional nests within a 1.6-km [1-mi] radius of the study area (Powertech, 2009a)"). EPA's SDWA permitting thus is likely involves prohibited take under federal wildlife laws, including direct and cumulative impacts on normal breeding, feeding, and/or sheltering behavior of bald eagles due to at least one confirmed, active nest in the project area. FSEIS at 3-46 to 3-47. Similarly, MTBA-listed raptor species, including "red-tailed hawk, American kestrel, and northern harrier [which] were the most commonly seen raptor species in the proposed project area and will be the primary raptor species impacted by project activities." FSEIS at 4-149.**

Response #371:

Federal agencies acting in their regulatory capacities, including under the SDWA, are not subject to the prohibitions of the MBTA or the BGEPA. See, 80 Fed. Reg. 30032, 30035 (May 15, 2015) and 74 Fed. Reg. 44,843 (Sep. 11, 2009). See also, *Protect Our Communities Foundation v. Jewell*, 825 F.3d 571, 585 (9th Cir. 2016). Thus, the Region is not subject to the Migratory Bird Treaty Act (MBTA) or Bald and Golden Eagle Protection Act (BGEPA) take provisions in its issuance of the SDWA permits and aquifer exemption approval to Powertech, a third party. Powertech, however, may be subject to the requirements of these statutes.

**372. A commenter stated that the Administrative Record does not include the site's available wildlife data in describing impacts to ecological resources. According to the commenter, scant use of citations in the Administrative Record makes it difficult to determine what available wildlife study data is used to describe the affected environment. The commenter further asserted that it is "reasonable to believe that wildlife data is only as current as the date of application. However, it must be noted that it has been almost 10 years since EPA has started its UGI evaluation. During that time, new**

**wildlife and habitat data have enhanced understanding of the site's ecological conditions. Also, recently listed ESA species may exist on site. The Administrative Record did not adequately describe the affected environment or impacts to ecological resources.”**

Response #372:

EPA has reviewed the wildlife and vegetation surveys commissioned by Powertech; Section 4.7 of the NRC SEIS, which assesses impacts to ecological resources; and Section 5.6.11 of the Large Scale Mine Permit. Section 5.6.11.2 of the proposed DENR Large Scale Mine Permit lists proposed measures to avoid or mitigate potential impacts to ecological resources at the site. These surveys are part of the administrative record. As described previously, EPA concluded that potential impacts of the SDWA actions on ecological resources are acceptable, based on: its review of the above-referenced information that Powertech has submitted to date; and the requirements Powertech has to comply with under South Dakota law for a Large Scale Mine Permit as described in Section 14.3 of the CEA. EPA’s process of evaluation of impacts to federally-listed species in compliance with Section 7 of the ESA is described in detail in Section 14.1 of the CEA. Further, the Biological Assessment that EPA completed, and which EPA submitted to the US Fish and Wildlife Service reviewed and concurred upon, is available for review under Docket EPA-R08-OW-2019-0512 on the Regulations.gov website. This BA and EPA’s process of evaluation is part of the administrative record.

Further, the US FWS concurred upon EPA’s final Biological Assessment in August 2020 regarding its list of species and critical habitats that may be affected within the project area. EPA’s evaluation of these ESA species is not limited to the time of Powertech’s application for the UIC permits. To date, EPA is not aware of any recently-listed ESA species that may exist at the project site.

**373. A commenter asserted that the rationale to determine impacts to short-horned lizard on page 149 of the Draft Cumulative Effects Analysis is unfounded. The commenter stated that the rationale presumes that native prairie, the preferred habitat of lizards, does not exist on rangelands and since impacts are on rangelands, lizards will not be impacted. The commenter was referring to the rationale from Section 6.0, Impacts To Land Use. The commenter noted that the baseline study from the project identifies native vegetation and "widespread occurrence" of an unknown lizard species. The commenter stated that the Administrative Record does not identify native vegetation, cumulative effects of conversion of native vegetation, or direct impacts on lizards. Another commenter raised concerns with EPA’s assessment in the proposed project area of the presence of a short-horned lizard. According to the commenter, the short-horned lizard is rare and protected in South Dakota. The commenter criticized the CEA’s characterization of the lizard, where after stating that the species is “important in some tribal cultures,” that EPA offers the solution “Once construction activities begin at the site, EPA expects that the [sic] any short-horned lizards that were in the area will seek less disturbed locations.” The commenter states that EPA’s solution is pure conjecture, without any back-up information on the size or habits of the lizards. The commenter asked “are they territorial, or is it species-appropriate for them to move? Are they large enough to move fast enough to out-run a bulldozer or pick-up truck? Or are they, in reality, unprotected?”**

Response #373:

EPA included a section on the short-horned lizard, a state-listed species, in its 2017 draft CEA to address a concern raised during the public hearing process. However, EPA has deleted this section and instead added a new section, Section 14.3, that evaluates South Dakota laws and requirements for issuance of the South Dakota Large Scale Mine Permit and Powertech's proposed LSMP to-date. Based on this review, EPA concluded that if Powertech implements measures to mitigate impacts on ecological resources, the effects will be short-term and acceptable. For example, the South Dakota laws require Powertech to: conduct a pre-mining assessment of wildlife and vegetation; provide a description of critical resources affected by the mining, including wildlife; and assess preventative measures to minimize harmful effects to wildlife. SDCL 45-6B-7(4) and (7); SDCL 45-6B-92(1); ARSD 74:29:07:02(6). The South Dakota laws also impose several requirements applicable to wildlife habitat including revegetation of the affected land after mining is completed. ARSD 74:29:07:22.

**374. See comments 103-107 on new wildlife requirements above. Powertech repeats these comments here and requests any changes made to these requirements be addressed here as well.**

Response #374:

Comments 103 through 107 that Powertech submitted are addressed in responses to the Endangered Species Act comments below. Please refer to this section for responses to these comments.

#### Endangered Species Act

**375. EPA must consult on its actions with the Fish and Wildlife Service (FWS) pursuant to Section 7(a)(2), 16 U.S.C. § 1536(a)(2) or risk civil and criminal penalties for "take". The commenter also stated that Powertech does not appear to have applied for a Section 10 Permit, and similarly faces ESA penalties for any "take" it may cause. 16 U.S.C. § 1539(a)(1)(B); 50 C.F.R. § 17.32(b).**

Response #375:

Consistent with 40 CFR § 144.4(c), and the Endangered Species Act (ESA) section 7(a)(2), EPA determined that its decision to issue UIC Permits are actions subject to the ESA and its implementing regulations (50 CFR part 402). EPA and the U.S. Fish and Wildlife Service (FWS or USFWS) worked collaboratively on the ESA consultation process in accordance with ESA section 7(a)(2) to ensure EPA's actions will not jeopardize the continued existence of federally-listed endangered or threatened species or result in the destruction or adverse modification of designated critical habitat of such species. Consistent with the ESA, EPA prepared a Biological Assessment (BA) analyzing potential effects to federally-listed species arising from its actions. There is no designated critical habitat for federally-listed species in the Dewey Burdock Project Area. On August 6, 2020, the FWS provided written concurrence with EPA's determination that its actions "may affect, but are not likely to adversely affect" the rufa red knot, northern long-eared bat and whooping crane. Powertech's independent obligations to comply with the ESA are outside the scope of EPA's regulatory responsibilities.

**376. In the Class V Fact Sheet and the Draft Cumulative Effects Analysis, EPA states that the Endangered Species Act will be complied with, but gives no information on how it intends to do this, when it will be done, what species will be considered, and who will do the analysis. The commenter also asserts that the ESA process should have been completed before the draft permits were put out for comment.**

Response #376:

The following is a summary of EPA's consultation process in accordance with ESA section 7(a)(2): EPA accessed the USFWS Information for Planning and Consultation (IPaC) and determined that three federally-listed species are potentially present in the Project Area: the rufa red knot (threatened), whooping crane (threatened) and northern long-eared bat (threatened). There is no designated critical habitat in the Project Area for these or any other federally-listed species. In 2019, EPA prepared a BA and determined that its SDWA actions "may affect, but are not likely to adversely affect" the three listed species. The FWS concurred with this conclusion in 2019. While not required to do so, EPA made the 2019 version of its BA available during the public review and comment process on its re-issued draft permits in August 2019. In 2020, EPA revised the BA in consideration of comments received during the public comment period on the draft UIC permits and aquifer exemption and based upon further research and discussions with the FWS. EPA prepared an updated BA on August 4, 2020, which supersedes the previous version. EPA requested written concurrence from the FWS on EPA's determination that its SDWA actions "may affect, but are not likely to adversely affect," the three listed species. In making these findings, EPA's BA analyzed the potential impacts of its actions on the federally-listed species, including appropriate mitigation measures. On August 6, 2020, the FWS provided written concurrence with EPA's determination that its actions "may affect, but are not likely to adversely affect," the rufa red knot, northern long-eared bat and whooping crane. Consistent with ESA section 7(a)(2), EPA concluded consultation with the FWS prior to its final permit decisions. EPA was not required to complete ESA consultation prior to issuance of its draft permits.

**377. The FWS July 8, 2019 letter concurring with the EPA's 2019 BA conclusion was not the concurrence EPA asked for on June 14, 2019 and should be clarified.**

Response #377:

The comment addresses the 2019 BA and FWS concurrence which have been superseded by the 2020 EPA BA and FWS concurrence. Specifically, on August 6, 2020, EPA received written concurrence from the FWS on EPA's determination that its actions "may affect, but are not likely to adversely affect," the rufa red knot, northern long-eared bat and whooping crane. The FWS's written concurrence concluded the ESA consultation process consistent with the ESA section 7(a)(2) requirements.

**378. The commenter states that: 1) the Administrative Record (AR) does not include the site's available wildlife data in describing impacts to ecological resources; 2) the data is 10 years old and recently listed ESA species may exist on site; 3) the scant use of citations in the AR makes it difficult to determine what available wildlife study data is used to**

**describe the affected environment; and 4) EPA did not adequately describe the affected environment or impacts to ecological resources.**

Response #378:

The sources cited in EPA's July 2020 BA reflect the most current information available for the analysis with respect to the presence of federally-listed species in the Project Area. EPA accessed the FWS IPaC data on May 1, 2019 and again on May 20, 2020. The FWS IPaC data contains the most up-to-date information on ESA listed species. As documented in its July 2020 BA, EPA also contacted the FWS directly to ensure the accuracy of the listed species data. Information on non-federally-listed wildlife and other species mentioned in the BA are for background purposes only as impacts to such species are not required to be analyzed under ESA section 7(a)(2). Additional information on potential impacts to non-federally-listed species can be found in the CEA Section 14.3 "Impacts on Other Ecological Resources" and 14.4 "Proposed Mitigation Measures in the DENR Large Scale Mine Permit" and are also referenced in Responses #372 and #373 above.

**379. The conservation/mitigation measures proposed by Powertech are unclear. The commenter also posed the following questions:**

- 1) Will these proposed measures be included in the final Permits and if so, will they be specific in term definition, extent, timing and amount of time allowed for completion?**
- 2) Will monitoring programs for water quality, raptors and other factors have specific parameters and require submission of reports to EPA and the FWS?**
- 3) Will wildlife experts be involved in establishing training programs for employees, raptor monitoring, and establishment of breeding and migratory seasons, etc.?**
- 4) How, specifically, will employees "allow" snakes and lizards to retreat?**
- 5) Who will be responsible for enforcing these measures? The commenter stated that without specific language in the Permits, these "proposed" measures are open to wide interpretation and will likely be unenforceable.**

Response #379:

Any references in EPA's BA to species that are not federally-listed as threatened or endangered, including in the "Conservation Measures" section, were included for background purposes only, as ESA section 7(a)(2) only requires analysis of federally-listed species. Thus, the BA analyzes the potential effects and appropriate mitigation measures only with regard to the federally-listed rufa red knot, northern long-eared bat and whooping crane. The UIC final permits include measures to mitigate potential impacts to these three ESA federally-listed species.

Additional information on potential impacts to non-federally-listed species can be found in the CEA Section 14.4 "Impacts on Other Ecological Resources" and 14.4 "Proposed Mitigation Measures in the DENR Large Scale Mine Permit" and Responses #372 and #373 above.

The following are specific responses to the five questions posed by the commenter:

- 1) Only the measures set forth in EPA's BA to mitigate potential impacts to federally-listed species, and concurred upon by the FWS, are included as permit requirements.

2) Water quality monitoring was not identified by EPA as an appropriate or reasonable measure to mitigate potential impacts to the three federally-listed species. Raptor monitoring was not included in EPA's BA since no federally-listed raptor species were identified in the Project Area.

3) The following mitigation measure included in EPA's BA and the final UIC permits describes how wildlife experts will be involved in training to ensure protection of federally-listed species:

- In the event that construction is planned during the whooping crane and rufa red knot migration seasons or the northern long-eared bat (NLEB) active season, within five days prior to the initiation of any construction activities, a qualified biologist must conduct pre-construction surveys for these species and training for workers to assist with the identification of all listed species during construction and operation.
  - Whooping crane migration seasons: migrates through South Dakota April 1 to mid-May and mid-September to mid-November.
  - Rufa red knot migration Seasons: migrates through South Dakota mid-April to mid-May and mid-September to October 31.
  - NLEB active season: mid-April to October 31. The critical pup season is June 1 to July 31.

4) No reptiles were identified as federally-listed species.

5) EPA may enforce the UIC permit conditions as appropriate, including those requirements necessary to mitigate potential impacts to ESA-listed species.

**380. The biological surveys submitted by Powertech and NRC are inadequate, stale and limited in scope. The commenter also states that NRC determined that the Powertech project may affect and even cause prohibited take to listed species, including whooping cranes, greater sage grouse (active leks), bald eagles, and golden eagles.**

Response #380:

The biological surveys submitted by Powertech to NRC were not used for EPA's ESA section 7(a)(2) consultation process with the FWS and therefore did not inform EPA's determination that its SDWA actions "may affect, but are not likely to adversely affect", the rufa red knot, northern long-eared bat or the whooping crane. In making these findings, EPA's BA analyzed the potential impacts of its actions on the federally-listed species, including appropriate mitigation measures. On August 6, 2020, the FWS provided written concurrence with EPA's determination. Therefore, EPA's SDWA actions do not result in any unauthorized take involving the whooping crane or any other listed species. The greater sage grouse (active leks), bald eagle, and golden eagle were not included in EPA's BA because they are not ESA-listed species. The Agency has no comment on the NRC's independent ESA consultation process or conclusions therein.



**381. The Agency is required to demonstrate compliance with the Migratory Bird Treaty Act (MBTA), and the Bald and Golden Eagle Protection Act (BGEPA). The federal agencies and staff involved that fail to comply with the laws mentioned above can be subject to civil and criminal penalties. In order for any federal agency to comply and proceed with its actions, the agency will need an approved Permit from the FWS.**

Response #381:

EPA has completed its ESA section 7(a)(2) compliance obligations. Federal agencies acting in their regulatory capacities are not subject to the prohibitions of the MBTA or the BGEPA. *See*, 80 Fed. Reg. 30032, 30035 (May 15, 2015) and 74 Fed. Reg. 44,843 (Sep. 11, 2009). *See also*, *Protect Our Communities Foundation v. Jewell*, 825 F.3d 571, 585 (9th Cir. 2016). Thus, EPA is not subject to the MBTA or BGEPA take provisions in its issuance of the SDWA Permits and aquifer exemption approval to Powertech, a third party. Powertech, however, may independently be subject to the requirements of these statutes.

**382. The commenter requests explanation of the draft permit's proposed requirement that if the whooping crane, rufa red-knot or northern long-eared bat are sighted within one mile of the UIC well sites or associated facilities during construction or operation, all work within one mile of the species' location must cease. Specifically, the commenter states that the one mile 'buffer' was arbitrarily increased from one-quarter mile to one mile, appears to be much greater than typical wildlife buffers and was formulated without basis. The commenter recommends that a mitigation plan be allowed to be developed upon observation of these species and that such a plan could involve various strategies to avoid a take.**

Response #382:

In consideration of this comment and upon further research and discussion with the U.S. FWS, EPA has changed the distance in this mitigation measure from one mile to one-half mile. In consultation with the FWS, EPA concludes that one-half mile strikes a more reasonable balance between the ability to positively identify a listed species and maintaining a distance that still provides an adequate buffer to protect these species. In addition, as discussed in Response #383 below, EPA has also modified the immediate cessation of work requirement so that it only applies to construction activities and not operations. EPA agrees that the development of a mitigation plan may also be beneficial and has clarified that upon sighting of a listed species, the Permittee must work with the FWS and a qualified biologist to ensure protection of the species (which could include a mitigation plan).

**383. The commenter requests modification of the requirement that all operations and construction must cease within one mile of the location of a sighting of a whooping crane, rufa red-knot or northern long-eared bat. In particular, the commenter asserts that active operations cannot be immediately ceased as this could endanger protection of USDWs because operations are required to be manned. The commenter states that this requirement could create serious issues with compliance conditions within the Class III permit, for example, the need to continuously maintain a bleed on the wellfield. The commenter recommends that a mitigation plan be allowed to be developed upon**

**observation of these species. The commenter questions the authority of the EPA to enforce such requirements. The commenter states such conditions are enforceable under the South Dakota DENR Large Scale Mine Permit, and these requirements are better applied in this fashion, with direct interaction with South Dakota Game, Fish and Parks (SDGFP), where trained wildlife biologists can determine an appropriate approach.**

Response #383:

EPA agrees that the immediate cessation of all operations within one mile of the sighting of a listed species is not appropriate given the need for certain surface activities to occur during operations and the relatively minimal potential impact to listed species from such activities. As further described in EPA's BA, wellfield operations primarily involve a number of subsurface activities including the underground production and transport of in-situ recovery related fluids by wells and pipelines. The cessation of all operations is not necessary for the protection of listed species because only minimal surface disturbance activity is expected from occasional truck traffic and the maintenance of surface structures (e.g., well header houses) during wellfield operations. Due to the minimal potential for impacts to listed species from surface activities related to wellfield operations, in coordination with the FWS, EPA has modified this mitigation measure by requiring that only construction activities cease in these circumstances, and not wellfield operations. The measure now requires that Powertech work with the FWS and a qualified biologist to minimize surface operation activities within one-half mile of the species' location. EPA's authority to include these mitigation measures as enforceable conditions in the permit comes from 40 CFR § 144.52(a) which states that, "the Director shall establish (permit) conditions, as required on a case by case basis under...§ 144.4 (considerations under Federal law)" which includes the ESA. EPA has determined, in consultation with the FWS, that such measures are necessary and appropriate to ensure protection of listed species from potential impacts associated with EPA's SDWA actions.

**384. The commenter states that this condition appears arbitrary and not tied to the known presence of wildlife of concern. Powertech suggests that this condition be modified so that if a whooping crane, rufa red-knot or northern long-eared bat have been confirmed at the site by trained wildlife biologist, then such a condition would be applied if deemed appropriate by a trained wildlife biologist.**

Response #384:

The referenced condition is the mitigation measure related to supplemental lighting during construction or operation. EPA has modified the measure to clarify that it is a surface operations protection measure for the northern long-eared bat since such lighting can attract bugs, and therefore bat species, to the project site. Consequently, this increases the likelihood of the northern long-eared bat being present near, and vulnerable to, activities occurring under the supplemental lighting. Therefore, if supplemental lighting is used during construction or operation activities, as a protection measure for this listed species, the lights must be directed and/or sheltered to minimize the amount of light escaping the work or project site.

**385. The commenter requests clarification on the Section 7 consultation with the Secretary of the Interior (U.S. Fish and Wildlife Service). Are the mitigation measures described in the draft permit a result of this consultation? If not, commenter requests that this section be revised once consultation has been completed.**

Response #385:

The mitigation measures in EPA's August 2019 draft permits were the result of EPA's consultation with the U.S. FWS. Specifically, EPA prepared a BA in 2019 with which the FWS concurred. The ESA-related draft UIC permit conditions reflected the 2019 consultation process. In 2020, EPA revised the BA in consideration of comments received during the public comment period on the draft UIC permits and aquifer exemption and based upon further research and discussions with the FWS. In August 2020, the FWS provided written concurrence with EPA's determination in its 2020 BA that EPA's SDWA actions may affect, but are not likely to adversely affect, the rufa red knot, northern long-eared bat and whooping crane.

**386. The commenter requests clarification on the frequency of the motion-activated camera monitoring. Commenter also requests clarification that additional monitoring will not be required if the shaft entrance is covered following a determination that no bats are inside the shaft.**

Response #386:

With regard to the frequency of motion-activated camera monitoring, during the northern long-eared bat active season (Mid-April to October 31), the permittee is required to use a motion-activated camera to monitor the Triangle Mine vertical ventilation shaft for 5 days and nights to determine if bats are entering and exiting. With regard to the need for additional monitoring, the permittee is not required to perform such monitoring if the shaft entrance is covered with finer mesh to prevent bats from entering following a determination that no bats were seen entering or exiting the shaft or found inside the shaft. This is because once the shaft is covered, additional monitoring would not be necessary since bats, including the northern long-eared bat, would not have access to the shaft.

#### Outside the Scope of the Actions

**A number of commenters raised issues that are outside the scope of factors that the EPA can consider in permitting or aquifer exemption actions. However, in the interest of providing information to the public, EPA provides responses below where it is possible to do so. These comments fell under the following categories:**

**A. Comments about compliance with South Dakota state laws**

Response A:

South Dakota state laws are outside the scope of the federal UIC program. EPA has no authority to enforce South Dakota's laws.

**B. Comments about hydraulic fracturing**

Response B:

Hydraulic fracturing is not part of the in-situ recovery of uranium process. There will be no hydraulic fracturing at the Dewey-Burdock project.

**C. Comments generally opposing or supporting the project**

Response C:

General opposition to or support of permitting decisions are not factors that EPA can consider in permitting or aquifer exemption actions.

**D. Comments about the economic viability of the Permittee company (with the exception of commercial producibility of the mineral, which is covered in aquifer exemptions, Comment #112 above)**

Response D:

Other than demonstrating and maintaining financial responsibility, the UIC regulations do not provide authority for EPA to consider economic viability of the Permittee company for the purpose of approving or denying a permit. Commercial producibility of the uranium is a factor in the aquifer exemption criterion at 40 CFR § 146.4(b)(1) and is discussed in Response #112 above.

**E. Comments about the Permittee that include the following: foreign company, allegations of lack of experience, skepticism of intentions, lack of compliance to plug boreholes per NRC order, allegations of legal misconduct, value of its stock, allegations about the permittee's financing, alleged insolvency; allegations about inability to meet standards in the permits.**

Response E:

These comments about the Permittee are all factors that EPA is not authorized to consider when approving or denying UIC permits. Some of the comments are speculative, some of them relate to compliance with laws outside the Safe Drinking Water Act, but none of the comments relate to requirements under the UIC program. Therefore, these comments are outside the scope of the factors that EPA can consider when making permit decisions.

**F. Comments about EPA's ability to regulate and oversee the injection wells**

Response F:

This comment does not suggest that the Permit or its conditions are not adequate to protect USDWs.

**G. Comments about the President's Executive Order to reduce the number of regulations**

Response G:

This action involves the issuance of two permits and approval of an aquifer exemption. There were no new rules promulgated. This comment regarding reduction of the number of regulations does not apply to and is outside the scope of these actions.

**H. Comments that EPA should independently gather the data required by the permit**

Response H:

Self-monitoring and self-reporting are consistent with the Safe Drinking Water Act (SDWA) and the UIC regulations. They are fundamental elements of the UIC permit program and other Federal regulatory programs, such as those under the Clean Water Act, Resource Conservation and Recovery Act, and Clean

Air Act. The UIC regulations (40 CFR § 144.51(k) and § 144.32) and the Permits have specific signatory requirements that certify that any reports submitted are complete, true, and accurate. The certification acknowledges that there are significant penalties for submitting false information.

**I. Comments about South Dakota's or NRC's ability to oversee the project**

Response I:

South Dakota and the Nuclear Regulatory Commission have regulatory responsibilities outside of the Safe Drinking Water Act (SDWA). These are outside the scope of the SDWA, and the ability of those agencies to regulate under laws it administers is not a factor that EPA can consider in approving or denying a UIC permit.

**J. Comments about future Clean Air Act Subpart W process - public education sessions and public comment periods**

Response J:

Any Clean Air Act subpart W process associated with this project will be done separately under the authority of the Clean Air Act and its regulatory process. This is outside the scope of the Safe Drinking Water Act.

**K. Comments about requirements to collect baseline air quality data**

Response K:

EPA does not have authority to require the Permittee to collect baseline air quality data under a Safe Drinking Water Act UIC permit.

**L. Comments about concern regarding future transfers of the permits**

Response L:

This comment speculates on the possibility that there will be a request for a permit transfer in the future. The UIC regulations do not allow EPA to consider this in the approval or denial of a permit. If there is a request for transfer in the future, it must be done in accordance with the Class III Area Permit, Part XII.A.3 and the UIC regulations.

**M. Comments about states having less stringent permitting requirements**

Response M:

See Response #77.

**N. Comments about the permits requiring more than what the NRC requires in its license under the Uranium Mill Tailings Radiation Control Act (UMTRCA)**

See Responses #80 and #81 above.

**O. Comments requesting that EPA require the permittee to recover other products/elements**

Response O:

The UIC regulations do not provide authority for EPA to require recovery of products or elements. The UIC regulations are designed to prevent endangerment of USDWs from underground injection.

**P. Comments accusing the EPA of pre-deciding the aquifer exemption before consideration of all the comments, based on an EPA official saying at the hearing: “the areas that we are exempting....” The commenter suggested this demonstrated that the exemption has already been granted.**

Response P:

EPA has provided extensive opportunities for the public to comment on the draft permits and proposed aquifer exemption. EPA carefully reviewed all of the public comments, and with regard to the aquifer exemption, EPA did not receive any information indicating that the aquifer exemption criteria were not met. While it is possible that EPA staff used incorrect terminology at the hearing, EPA was very transparent with its documents and was open to making changes based on comments if the comments warranted it.

**Q. Comments asserting that the permitting and aquifer exemption actions are contrary to the EPA’s mission of protecting drinking water and air quality; comments that the EPA is protecting business interests over the environment**

Response Q:

This comment does not make any assertions that the Permits and their conditions are not adequate to protect USDWs. EPA’s role in the issuance of UIC permits is to ensure that the injection activity can be done in a manner that prevents contamination of USDWs.

**R. Comments on the South Dakota DENR’s draft documents for the Large Scale Mine Permit**

Response R:

EPA cannot accept comments on the South Dakota Department of Environment and Natural Resources (DENR) documents. These documents were not drafted for purposes of the Safe Drinking Water Act and the UIC program. Any comments on those documents should be submitted to the South Dakota DENR in accordance with their process.

**S. Comments about health effects associated with exposure to uranium and metals released by the ISR process. Commenters cited several examples of contamination associated with mining sites in Texas, Wyoming, and New Mexico.**

Response S:

This comment does not make any assertions that the Permits and their conditions are not adequate to protect USDWs. EPA’s role in the issuance of UIC permits is to ensure that the injection activity can be done in a manner that prevents contamination of USDWs. This comment assumes there will be exposure, whereas the Permits are designed to prevent human exposure to contaminants.

- T. Comment that any water taken from the Madison Formation should be returned to that formation, expressing concern about impacts on water quality that could affect its uses for drinking, livestock, and wildlife.**

Response T:

EPA is aware of Powertech's application to the SD DENR Water Rights Program for the consumption of Madison aquifer groundwater during groundwater restoration and as a possible alternative water supply to using Inyan Kara groundwater at the site. Groundwater consumption issues are outside the regulatory authority of EPA. However, EPA addressed the consumption of Madison aquifer groundwater in Section 3.2.1 of the CEA. EPA clarifies that there are no plans to use Madison Formation water for disposal of wastewater. Therefore, this comment is not relevant to the permitting and aquifer exemption actions before us.

- U. Several commenters, including Powertech, expressed frustration about the length of time it took the EPA to issue the permits, asserting that the slow turnaround deters innovation and subjects the Permittee to economic and competitive disadvantages.**

Response U:

The time needed for the permit application reviews reflects information exchange between the applicant and EPA, the needed evaluations of the complex project, along with the tribal consultations and consideration of thousands of pages of public input. EPA adds that the purpose of the UIC regulations and the Class III and Class V Area Permits is to ensure protection of USDWs, and that the financial or economic impacts to the Permittee of meeting the permit conditions is outside the scope of what the Director may consider in making permit decisions.

- V. Black Hills Army Depot If we disturb the area with injection wells, bore holes etc., and force toxic sludge under pressure into the underground areas riddled with the massive Wind Cave structure, we will get the BHAD contaminants moving in the plume. These are soluble in oil and water. Deep injection wells will unleash a catastrophic moving lethal torrent underground that will kill everything it touches, borne by oil and water wells. That plume will flow directly towards the city of Hot Springs, poisoning the local Minnelusa wells, of which 22 on the west side are now.**

Response V:

The Black Hills Army Depot is approximately 14 south of the Dewey Burdock project and will not be affected by the injection activity.

- W. Comments about trespassers using the wells to dump toxic waste**

Response W:

Speculation about the potential for future trespassers to dump illegal waste into the Permittee's wells is not a factor that EPA could consider in the approval or denial of a permit. However, the Permittee plans to fence the project area to ensure site security. To comply with NRC regulations found at 10 CFR part 20, Subpart I, Powertech must secure areas where licensed materials are stored from unauthorized removal or access. In Section 5.6 of the Technical Report that is part of the NRC License application

covers facility security measures, Powertech commits to installing fencing to secure all areas where licensed material is stored. This includes the treatment ponds. Appendix 3.1-A to the Technical Report Powertech submitted to NRC as part of the License application contains pond construction specifications. The Figures in this appendix show the proposed fences around the ponds. The figure below shows examples fences around treatment and storage ponds.

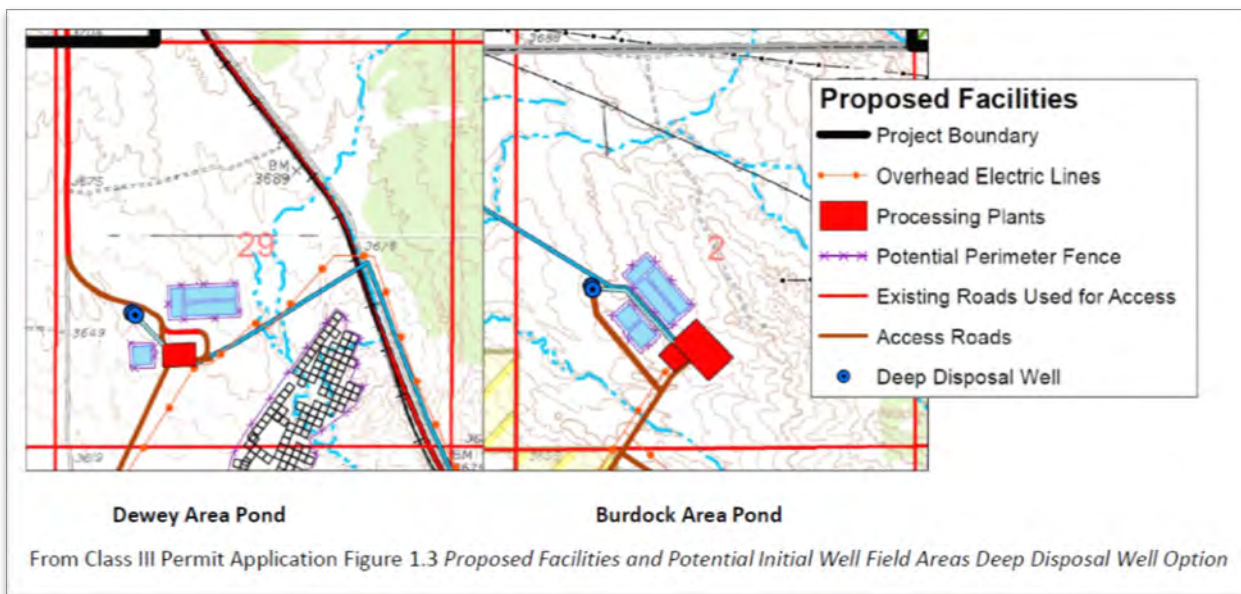

**X. Comments that generally asserted that old abandoned uranium mines should be fully reclaimed before new mining is permitted.**

Response X:

EPA's UIC program does not have authority to require that the Permittee reclaim other abandoned mines in the area. Therefore, it is outside of scope of the UIC program.

**Y. One commenter expressed concern about constituents clogging well screens and expressed that providing adequate well monitoring and maintenance programs for all the wells, including the monitoring wells, will ensure well operational efficiency and extend the life of the wells throughout the project.**

Response Y:

The UIC regulations do not address clogged wells screens, as this has more to do with performance and efficiency of UIC wells, not protection of USDWs. Therefore, this is outside the scope of UIC regulatory authority. These are issues for the Permittee to address. As described in Part V, Section E.5 of the Class III Area Permit, the Permittee has the option to construct the Class III injection wells with an open hole completion in the targeted uranium ore deposit.

**Z. One commenter raised concerns about erosion but raised concerns about statements in Powertech's South Dakota Large Scale Mine Permit application: 5.3.9.2 states only that erosion of disturbed areas will be minimized. There are three problems with this assurance. a) P/Ts admittance of the disturbed areas in the first place, b) they will not try to prevent any**



**erosion outside of the disturbed areas only minimize the erosion inside the disturbed areas and c) they admit that they will not even attempt to repair the erosion to its original state. Public health is not served by this cavalier attitude towards runoff prevention. In 5.3.4.4 it admits that “all grades will provide for natural runoff” which as we have seen only further guarantees the flowing of contamination into the creeks and rivers.**

Response Z:

This comment refers to the South Dakota Large Scale Mine Permit application, which is outside the scope of the UIC Program. However, EPA Cumulative Effects Analysis addresses the potential for soil erosion, and in the interest of providing information to the public, we describe those sections here.

As described in Section 7 of the Cumulative Effects Analysis, the greatest impacts to soils will occur during the construction phase, primarily from earthmoving activities during construction of ISR surface facilities, roads, wellfields, and pipelines. Section 5.4 of the Environmental Report includes a list of proposed Mitigation Measures for Surface Water Impacts from the Proposed Action. Many of these measures are designed to minimize potential for erosion. The Permittee will be required, under Section 5.6.2 of the Large Scale Mine Permit, to implement mitigation measures to limit potential soil erosion impacts. Potential soil impacts during the ISR and aquifer restoration phases may result from pipeline leaks (which are not covered under the UIC permits); these would be mitigated by routine monitoring and mandated spill reporting and recovery actions. The decommissioning phase will impact soils in a manner similar to that of the construction phase. Therefore, EPA has concluded, based on a review of information in the Large Scale Mine Permit and the NRC SEIS, that there should be no long-term impact to soils.

Other measures that the Permittee must take to reduce or mitigate soil erosion are described in the EJ Analysis. For example, the NRC license requires the Permittee to develop a Water Management and Erosion Control Plan, which will include mitigation measures to control drainage, erosion, and sedimentation. This plan must be implemented during and after ISR operations to reduce soil loss within the permit area. Under the SD DENR NPDES permit, the Permittee must develop and implement a SWPPP to minimize soil erosion and the discharge of pollutants during earth-disturbing activities, and those controls must be designed to function properly and withstand a 2-year, 24-hour precipitation event.

**APPENDIX**

**POWERTECH COMMENT TABLES WITH EPA RESPONSES**



Table 1. Draft Class III Area Permit Specific Comments and Recommended Permit Language Revisions

No.	Page	Recommended Alternative Language or Other Modification	Explanation of Alternative(s)	Comment																																							
10	16	<p><b>Table 4. Observation Wells for Monitoring the Integrity of the Morrison Formation Lower Confining Zone</b></p> <table border="1"> <tr> <td>DRJ 90</td> <td>SESE Section 35 T6S R1E <del>T6S R1E</del></td> </tr> <tr> <td>DB08-1-7</td> <td>SE Section 1 T7S R1E</td> </tr> </table>	DRJ 90	SESE Section 35 T6S R1E <del>T6S R1E</del>	DB08-1-7	SE Section 1 T7S R1E	Typographical correction.	There is a typo in "T6S R1E T6S R1E."																																			
DRJ 90	SESE Section 35 T6S R1E <del>T6S R1E</del>																																										
DB08-1-7	SE Section 1 T7S R1E																																										
16	20	<p><b>Table 8. Baseline Water Quality Parameter List</b></p> <table border="1"> <thead> <tr> <th>Test Analyte/Parameter*</th> <th>Units</th> <th>Analytical Method</th> </tr> </thead> <tbody> <tr> <td colspan="3" style="text-align: center;"><b>Physical Properties</b></td> </tr> <tr> <td>pH**</td> <td>pH Units</td> <td>A4500-H B</td> </tr> <tr> <td>Total Dissolved Solids (TDS)</td> <td>mg/L</td> <td>A2540C</td> </tr> <tr> <td>Specific Conductance**</td> <td>µmhos/cm at 25°C</td> <td>A2510B or E120.1</td> </tr> <tr> <td><del>Specific Gravity</del></td> <td><del>Ratio to density of water</del></td> <td><del>ASTM D1429-13, SM 2710F</del></td> </tr> <tr> <td><del>Turbidity</del></td> <td><del>nephelometric turbidity units (NTU)</del></td> <td><del>EPA-NERL: 180.1</del></td> </tr> <tr> <td colspan="3" style="text-align: center;"><del>Groundwater quality parameters related to mobility of uranium and other metals</del></td> </tr> <tr> <td><del>Temperature</del></td> <td><del>°C</del></td> <td><del>2014 EPA Region 4 SOP (Temperature)</del></td> </tr> <tr> <td><del>Dissolved Oxygen</del></td> <td><del>mg/L</del></td> <td><del>2017 EPA Region 4 SOP (DO)</del></td> </tr> <tr> <td><del>Oxidation-Reduction Potential</del></td> <td><del>Millivolts (mV)</del></td> <td><del>2017 EPA Region 4 SOP (ORP)</del></td> </tr> <tr> <td><del>Carbon Dioxide</del></td> <td><del>mg/L</del></td> <td></td> </tr> <tr> <td><del>Total Organic Carbon</del></td> <td><del>mg/L</del></td> <td><del>415.3, 9060A</del></td> </tr> </tbody> </table>	Test Analyte/Parameter*	Units	Analytical Method	<b>Physical Properties</b>			pH**	pH Units	A4500-H B	Total Dissolved Solids (TDS)	mg/L	A2540C	Specific Conductance**	µmhos/cm at 25°C	A2510B or E120.1	<del>Specific Gravity</del>	<del>Ratio to density of water</del>	<del>ASTM D1429-13, SM 2710F</del>	<del>Turbidity</del>	<del>nephelometric turbidity units (NTU)</del>	<del>EPA-NERL: 180.1</del>	<del>Groundwater quality parameters related to mobility of uranium and other metals</del>			<del>Temperature</del>	<del>°C</del>	<del>2014 EPA Region 4 SOP (Temperature)</del>	<del>Dissolved Oxygen</del>	<del>mg/L</del>	<del>2017 EPA Region 4 SOP (DO)</del>	<del>Oxidation-Reduction Potential</del>	<del>Millivolts (mV)</del>	<del>2017 EPA Region 4 SOP (ORP)</del>	<del>Carbon Dioxide</del>	<del>mg/L</del>		<del>Total Organic Carbon</del>	<del>mg/L</del>	<del>415.3, 9060A</del>	Powertech requests modifying the baseline water quality parameter list for consistency with NRC license requirements.	<p>There is an inconsistency between the NRC license and draft permit in terms of the parameters sampled during baseline monitoring in the perimeter monitoring wells, wells completed within the injection interval, and non-injection interval monitoring wells. License Condition 11.3 of SUA-1600 (Exhibit 016 in Powertech's Original EPA Letter) requires Powertech to sample these wells for the parameters listed in Table 6.1-1 of the approved NRC license application. Part II, Section E.2.b.iii would require Powertech to have samples from the same wells analyzed for a different set of parameters. Powertech has edited the list so that inconsistencies with the NRC license are made consistent.</p> <p>Since these wells typically would be within the exempted aquifer, Powertech questions the need to significantly expand the list of parameters beyond what was</p>
Test Analyte/Parameter*	Units	Analytical Method																																									
<b>Physical Properties</b>																																											
pH**	pH Units	A4500-H B																																									
Total Dissolved Solids (TDS)	mg/L	A2540C																																									
Specific Conductance**	µmhos/cm at 25°C	A2510B or E120.1																																									
<del>Specific Gravity</del>	<del>Ratio to density of water</del>	<del>ASTM D1429-13, SM 2710F</del>																																									
<del>Turbidity</del>	<del>nephelometric turbidity units (NTU)</del>	<del>EPA-NERL: 180.1</del>																																									
<del>Groundwater quality parameters related to mobility of uranium and other metals</del>																																											
<del>Temperature</del>	<del>°C</del>	<del>2014 EPA Region 4 SOP (Temperature)</del>																																									
<del>Dissolved Oxygen</del>	<del>mg/L</del>	<del>2017 EPA Region 4 SOP (DO)</del>																																									
<del>Oxidation-Reduction Potential</del>	<del>Millivolts (mV)</del>	<del>2017 EPA Region 4 SOP (ORP)</del>																																									
<del>Carbon Dioxide</del>	<del>mg/L</del>																																										
<del>Total Organic Carbon</del>	<del>mg/L</del>	<del>415.3, 9060A</del>																																									





**Table 1. Draft Class III Area Permit Specific Comments and Recommended Permit Language Revisions (cont.)**

No.	Page	Recommended Alternative Language or Other Modification			Explanation of Alternative(s)	Comment
		<del>Dissolved Organic Carbon</del>	mg/L	<del>415.3, 9060A</del>		approved by NRC, especially since that list was taken directly from NRC guidance (NUREG-1569, Exhibit 012 in Powertech’s Original EPA Letter) and reflects constituents typically affected by ISR operations. Overall, the addition of the extra parameters would add substantial cost without providing any added protection for USDWs beyond what is already required by NRC license requirements.
		<b>Common Elements and Ions</b>				
		Total alkalinity (as Ca CO <sub>3</sub> )	mg/L	A2320B		
		Bicarbonate Alkalinity (as Ca CO <sub>3</sub> )	mg/L	A2320B (as HCO <sub>3</sub> )		
		Calcium	mg/L	E200.7		
		Carbonate Alkalinity (as Ca CO <sub>3</sub> )	mg/L	A2320B		
		Chloride, Cl	mg/L	A4500-Cl B; E300.0		
		Magnesium, Mg	mg/L	E200.7		
		Nitrate, NO <sub>3</sub> <sup>-</sup> (as Nitrogen)	mg/L	E300.0		
		Potassium, K	mg/L	E200.7		
		<del>Silica, Si</del>	<del>mg/L</del>	<del>E200.7</del>		
		Sodium, Na	mg/L	E200.7		
		Sulfate, SO <sub>4</sub>	mg/L	A4500- SO <sub>4</sub> E; E300.0		
		<b>Dissolved Metals</b>				
		Arsenic, As	mg/L	E200.8		
		Barium, Ba	mg/L	E200.8		
		Boron, B	mg/L	E200.7		
		Cadmium, Cd	mg/L	E200.8		
		Chromium, Cr	mg/L	E200.8		
		Copper, Cu	mg/L	E200.8		
		Fluoride, F	mg/L	E300.0		
		Iron, Fe	mg/L	E200.7		
		Lead, Pb	mg/L	E200.8		
		Manganese, Mn	mg/L	E200.8		
		Mercury, Hg	mg/L	E200.8		
		Molybdenum, Mo	mg/L	E200.8		





**Table 1. Draft Class III Area Permit Specific Comments and Recommended Permit Language Revisions (cont.)**

No.	Page	Recommended Alternative Language or Other Modification	Explanation of Alternative(s)	Comment																																	
		<table border="1"> <tr> <td>Nickel, Ni</td> <td>mg/L</td> <td>E200.8</td> </tr> <tr> <td>Selenium, Se</td> <td>mg/L</td> <td>E200.8; A3114 B</td> </tr> <tr> <td>Silver, Ag</td> <td>mg/L</td> <td>E200.8</td> </tr> <tr> <td>Uranium, U</td> <td>mg/L</td> <td>E200.7, E200.8</td> </tr> <tr> <td>Vanadium, V</td> <td>mg/L</td> <td>E200.7, E200.8</td> </tr> <tr> <td>Zinc, Zn</td> <td>mg/L</td> <td>E200.8</td> </tr> <tr> <td colspan="3" style="text-align: center;"><b>Radiological Parameters</b></td> </tr> <tr> <td>Adjusted Gross Alpha***</td> <td>pCi/L</td> <td>E900.0</td> </tr> <tr> <td><del>Gross Beta</del></td> <td><del>pCi/L</del></td> <td><del>E900.0</del></td> </tr> <tr> <td>Radium, Ra-226</td> <td>pCi/L</td> <td>E903.0</td> </tr> <tr> <td><del>Radium, Ra-228</del></td> <td><del>pCi/L</del></td> <td><del>E904.0</del></td> </tr> </table> <p>*Laboratory analysis only, except where indicated.  **Field and Laboratory  ***Excluding radon and uranium.</p>	Nickel, Ni	mg/L	E200.8	Selenium, Se	mg/L	E200.8; A3114 B	Silver, Ag	mg/L	E200.8	Uranium, U	mg/L	E200.7, E200.8	Vanadium, V	mg/L	E200.7, E200.8	Zinc, Zn	mg/L	E200.8	<b>Radiological Parameters</b>			Adjusted Gross Alpha***	pCi/L	E900.0	<del>Gross Beta</del>	<del>pCi/L</del>	<del>E900.0</del>	Radium, Ra-226	pCi/L	E903.0	<del>Radium, Ra-228</del>	<del>pCi/L</del>	<del>E904.0</del>		
Nickel, Ni	mg/L	E200.8																																			
Selenium, Se	mg/L	E200.8; A3114 B																																			
Silver, Ag	mg/L	E200.8																																			
Uranium, U	mg/L	E200.7, E200.8																																			
Vanadium, V	mg/L	E200.7, E200.8																																			
Zinc, Zn	mg/L	E200.8																																			
<b>Radiological Parameters</b>																																					
Adjusted Gross Alpha***	pCi/L	E900.0																																			
<del>Gross Beta</del>	<del>pCi/L</del>	<del>E900.0</del>																																			
Radium, Ra-226	pCi/L	E903.0																																			
<del>Radium, Ra-228</del>	<del>pCi/L</del>	<del>E904.0</del>																																			
19	21	See comment #16.	Powertech requests omitting silica from the baseline water quality parameter list.	<p>It is appropriate to remove silica from the list of baseline water quality parameters on the following basis:</p> <ol style="list-style-type: none"> <li>1. It is not required by NRC license requirements (see Table 6.1-1 of the approved NRC license application).</li> <li>2. Powertech could find no basis for requiring analysis of silica in all monitoring wells or for establishing compliance limits for silica based on the baseline sampling results.</li> <li>3. Even in the context of reactive transport modeling, the</li> </ol>																																	





Table 1. Draft Class III Area Permit Specific Comments and Recommended Permit Language Revisions (cont.)

No.	Page	Recommended Alternative Language or Other Modification	Explanation of Alternative(s)	Comment
				benefits of having silica data would be slight. The near neutral pH present in typical ISR lixivants will do little to dissolve silicate minerals.
23	22-23	<p><b>G. Additional Requirements to Obtain Authorization to Commence Injection for Burdock Wellfields 6, 7 and 8</b></p> <p>1. Because the Chilson Sandstone downgradient from Burdock Wellfields 6, 7 and 8 has been partially oxidized by native groundwater, the Permittee shall evaluate the capacity of the downgradient Chilson Sandstone to remove residual contamination from restored wellfield groundwater as it travels downgradient toward the aquifer exemption boundary.</p> <p>2. To fulfill this requirement the Permittee shall:</p> <p><del>a. Develop Conceptual Site Models for wellfields 6, 7 and 8 by conducting all the sampling and testing required for all wellfields as described under this Part.</del> Conduct geochemical modeling using site-specific data to demonstrate that contaminants will not cross the down-gradient aquifer exemption boundary and cause a violation of any primary MCLs or otherwise adversely affect the health of persons.</p> <p><del>b. In addition, the Permittee shall expand the Conceptual Site Model for wellfields 6, 7 and 8 by collecting samples from the downgradient injection interval for the purposes of characterizing the geochemistry of the downgradient injection interval.</del></p> <p><del>c. In addition, the Permittee shall further expand the Conceptual Site Model for wellfields 6, 7 and 8 by conducting</del> column testing, batch sorption testing, or other appropriate laboratory and field testing methods to provide site-specific inputs into the geochemical model, as specified in Part IV, Section C.</p> <p><del>d. The Permittee shall calibrate the geochemical model using analytical data from field and laboratory testing as specified in Part IV, Section B.5.</del></p> <p><del>c.e.</del> Submit the <del>Conceptual Site Model and</del> geochemical modeling results to the Director as part of the Injection Authorization Data</p>	Powertech requests removing <b>G. Additional Requirements to Obtain Authorization to Commence Injection for Burdock Wellfields 6, 7 and 8</b> because the additional requirements are inconsistent with the NRC license. Powertech requests that EPA leave matters pertaining to the evaluation of the suitability of these wellfields and the data collection requirements for these wellfields to the NRC who retains the regulatory authority on this matter. However, if the EPA does not satisfy this request, Powertech requests these edits be made.	The scope of geochemical modeling in the Revised Draft Class III Permit is far beyond the Proposed Alternate Solution to Post-Restoration Groundwater Monitoring included in Attachment A-3 of Powertech’s Original EPA Letter. In its proposed alternative, Powertech envisioned two geochemical models being completed, one for each major wellfield area (i.e., one geochemical model for the Dewey area and one for the Burdock area), each generated after the successful conclusion of all ISR activities within each major wellfield area and following the NRC-approved closure of all wellfields within each major wellfield area. Regardless, NRC requirements apply to these wellfields and if they are authorized by NRC, they meet the requirements of demonstrating that contaminants will not cross the down-gradient aquifer exemption boundary. Further, under NRC regulation, there has NEVER been an occurrence of a





Table 1. Draft Class III Area Permit Specific Comments and Recommended Permit Language Revisions (cont.)

No.	Page	Recommended Alternative Language or Other Modification	Explanation of Alternative(s)	Comment
		<p>Package Report for each wellfield evaluating the potential for ISR contaminants to cross the downgradient aquifer exemption and cause a violation of any primary MCLs or otherwise adversely affect the health of persons. <del>boundary.</del></p> <p>3. If, during the wellfield pump tests using a pumping rate simulating production and restoration in Burdock Wellfields 6, 7 or 8, the Chilson aquifer potentiometric surface is drawn down to the point where the proposed injection interval becomes less than fully saturated, the Permittee shall develop a 3-D unsaturated groundwater flow model for the area where less than fully saturated conditions are anticipated.</p> <p><del>a. The model shall be calibrated to site-specific hydrologic conditions and verified by use of wellfield-specific pump test data.</del></p> <p><del>b. The model shall assess the ability to maintain hydraulic control in the partially saturated injection interval and demonstrate the ability to detect and reverse excursions in the partially saturated injection interval and in the first overlying non-injection interval aquifer.</del></p> <p><del>c. The model shall incorporate the effects of concurrent production and restoration activities in other Burdock wellfields on the Chilson aquifer potentiometric surface in the areas where partially saturated injection intervals are anticipated.</del></p> <p><del>4. The results from the additional requirements for Burdock Wellfields 6, 7 and 8 shall be included in the Injection Authorization Data Package Report for each of these respective wellfields.</del></p> <p><del>5. If the aquifer exemption for Burdock Wellfields 6 and 7 has not been approved upon issuance of this Final Area Permit, the results from these additional requirements for Burdock Wellfield 6 and 7 shall be submitted to the Director as part of the aquifer exemption request.</del></p> <p><del>6. After review of groundwater flow model results, if the Director determines that additional hydrologic testing using pumping and injection is required to verify the groundwater flow model, the Director may issue a Limited Authorization to Inject in order to</del></p>		<p>migration of ISR ore body fluids to adjacent, non-exempt aquifers.</p>





Table 1. Draft Class III Area Permit Specific Comments and Recommended Permit Language Revisions (cont.)

No.	Page	Recommended Alternative Language or Other Modification	Explanation of Alternative(s)	Comment
		<p><del>allow reinjection of groundwater pumped from the field test site pumping well(s) for the purposes of hydrologic testing only.</del></p> <p><del>7. The Director will issue a Limited Authorization to Inject into Burdock Wellfields 6 and 7 only after the aquifer exemption for those two wellfields has been approved according to Section I.3 of this Part.</del></p> <p><b>H. Injection Authorization Data Package Reports</b></p> <p>1. An Injection Authorization Data Package Report shall be prepared for each wellfield and submitted to the EPA UIC Program Director for review in order to obtain written Limited Authorization to Inject for each wellfield.</p> <p>2. The information in this report shall become part of the Conceptual Site Model required under Part IV, Section A.</p> <p>3. Each Injection Authorization Data Package Report shall contain a description of all logging and testing procedures required under Part II, Sections B through F (<del>Sections B through G for Burdock Wellfields 6, 7 and 8</del>)</p>		
24	24	<p><b>II.H. Injection Authorization Data Package Reports</b></p> <p>2.o. Estimation of wellfield maximum injection pressure calculated using an estimated fracture pressure equation under Part V, Section F.3 of this Permit and depth measurement of the injection interval top from wellfield delineation drilling and logging for the purpose of selecting well casing and piping that meet requirements under Part VIII, Sections <del>E.2.c and E.3.c</del> <b>E.1.</b></p>	<p>Powertech requests changing the reference for maximum injection pressure to Part VIII, Section E.1.</p>	<p>Part V, Section F is referenced for the equation for the maximum injection pressure; however, that section contains the fracture pressure equation but not the maximum injection pressure equation.</p>
38	51	<p><b>B. Requirement to Demonstrate and Maintain Mechanical Integrity</b></p> <p>1. The Permittee is required to ensure each injection well and production well maintains mechanical integrity at all times. Injection into a well that lacks mechanical integrity is prohibited.</p> <p>2. Before the Authorization to Commence Injection is issued by the Director for each wellfield, the Permittee shall demonstrate that each wellfield injection and production well installed during development of the Injection Authorization Data Package Report has mechanical integrity according to 40 CFR § 146.8.</p>	<p>Inconsistent with NRC license requirements.</p>	<p>Powertech requests removal of the requirement to receive written authorization from the Director for a successful MIT prior to commencing operation of injection and production wells constructed after the Authorization to Commence Injection is issued. The requirement to obtain Director approval for wells that successfully pass MIT is inconsistent with</p>







Table 1. Draft Class III Area Permit Specific Comments and Recommended Permit Language Revisions (cont.)

No.	Page	Recommended Alternative Language or Other Modification	Explanation of Alternative(s)	Comment
		<p>3. For injection and production wells constructed after the Director issues the initial Authorization to Commence Injection, the Permittee shall send documentation to the Director demonstrating that each well has mechanical integrity.</p> <p><del>4. The Permittee must receive written authorization from the Director prior to commencing operation of additional wells.</del></p> <p><b>Table 13. Well Testing Program</b></p> <p>Updates required to sentences under the column labeled “Due Date”:</p> <p><del>Before Authorization to Commence Injection is issued for wells constructed before the wellfield pump test is conducted.</del></p> <p><del>For wells constructed after initial Authorization to Commence Injection, demonstration of mechanical integrity must be submitted to the Director for written approval before commencing operation.</del></p> <p>For injection and production wells constructed after the Director issues the initial Authorization to Commence Injection, the Permittee shall send documentation to the Director demonstrating that each well has mechanical integrity.</p>		License Condition 10.5 of SUA-1600. If the well passes MIT, Powertech should have the capability of operating the well immediately, in conformance with the approved NRC license. See also comment #83.
43	56	<p><b>VII.F.5. Hydraulic Control of Wellfield during Groundwater Restoration</b></p> <p>c. The Permittee shall monitor the water levels in the wellfield perimeter monitoring well ring in accordance with the requirements in Part IX, Section B.1.e, Table 14.D<del>F</del> and Part IX, Section C.</p>	Powertech requests correcting the reference from “Table 14.D” to “Table 14.F,” which contains the 60 Day Interval Excursion Monitoring During Groundwater Restoration and Stability Monitoring.	Reference is made to Table 14D, but that contains monitoring requirements during ISR operations rather than groundwater restoration.
49	61-75	<p>Remove Table 14C.</p> <p>Remove Table 14D.</p>	Understanding that EPA’s primary concern is	The draft permit contains many duplicative monitoring





Table 1. Draft Class III Area Permit Specific Comments and Recommended Permit Language Revisions (cont.)

No.	Page	Recommended Alternative Language or Other Modification	Explanation of Alternative(s)	Comment
		<p>Remove Table 14F.  Remove the following from Table 14G:</p> <ul style="list-style-type: none"> <li>- Samples from operational monitoring stock wells within permit area for chloride, total alkalinity, and specific conductance</li> <li>- Samples from domestic wells and operational monitoring wells listed in Table 16 for baseline parameters (Table 8)</li> <li>- Any updates to the Conceptual Site Model required under Part IV, Section A.3.</li> </ul> <p>Remove Table 16.  Remove Figures 8-12.</p> <p>Powertech requests adding this as a replacement:</p> <p><b>IX.F. Reporting Requirements</b>  <b>10. Submittal of NRC Reports and Documents</b>  a. The Permittee shall submit, for informational purposes only and at the same time as provided to NRC, the following information:</p> <ul style="list-style-type: none"> <li>i. All groundwater sampling data.</li> <li>ii. The semi-annual report required by NRC under License Condition 11.1B, which discusses the status of wellfields in operation. The report includes the progress of wellfields in restoration and restoration progress, status of any long-term excursions, and a summary of MITs conducted during the reporting period.</li> <li>iii. The groundwater quality data required by NRC under License Condition 11.3. This data includes the background water quality for the ore zone, overlying aquifers, underlying aquifers alluvial aquifer, and perimeter monitoring areas.</li> <li>iv. Water quality data from the annual samples required by NRC under License Condition 12.10 for each domestic well within 2 km (1.25 miles) of the boundary of each wellfield as measured from the perimeter monitoring well rings.</li> </ul>	<p>to be provided with the results of the monitoring performed under NRC license requirements, Powertech requests that EPA remove duplicative monitoring requirements for monitoring required by the NRC license. This includes excursion monitoring (Tables 14C, 14D and 14F), stock and domestic well monitoring (Table 14G) and sampling operational monitoring wells (Table 14G, Table 16 and Figures 8-12). The reporting requirements under Table 14G would require Powertech to provide monitoring results to EPA in the quarterly reports, without the need to specify monitoring locations, frequencies, or parameters in the Class III permit.</p>	<p>requirements with those required by NRC. This includes excursion monitoring (Tables 14C, 14D and 14F), stock and domestic well monitoring (Table 14G) and sampling operational monitoring wells (Table 14G, Table 16 and Figures 8-12). Explicitly calling out each monitoring well, sampling frequency, etc. in the Class III permit would require modifying the permit in the event that a monitoring location is changed or added. This would be unduly burdensome for monitoring performed under NRC's jurisdiction. Powertech would be willing to submit to EPA any groundwater monitoring results and applicable changes in the NRC license monitoring requirements. Powertech requests adding a new Section 10 under the Part IX, Section F reporting requirements as shown.</p>





**Table 1. Draft Class III Area Permit Specific Comments and Recommended Permit Language Revisions (cont.)**

No.	Page	Recommended Alternative Language or Other Modification	Explanation of Alternative(s)	Comment
		<p>v. Water quality data from the quarterly samples required by NRC under License Condition 12.10 for each stock well within the permit area.</p> <p>vi. Water quality data from the quarterly samples required by Section 5.7.8.2 of the approved NRC license application for each operational monitoring well.</p> <p>vii. Any reports submitted to NRC regarding excursions, including initial reports, follow-up reports, progress reports and quarterly reports required under License Condition 11.1 that include excursion parameter concentrations, wells placed on or removed from excursion status, corrective actions taken, and the results for all wells that were on excursion status during the quarter.</p>		
51	59	<p><b>Table 14. Monitoring Parameters and Frequency</b></p> <div style="border: 1px solid black; padding: 5px;"> <p><b>F. 60 DAY INTERVAL EXCURSION MONITORING DURING GROUNDWATER RESTORATION <del>AND STABILITY MONITORING</del></b></p> </div>	<p>As described in comment #49, Powertech requests removal of Table 14F, since it contains monitoring requirements under NRC regulatory jurisdiction. In the event that the table is not removed, Powertech requests modification of the table title for consistency with NRC license requirements.</p>	<p>The proposed requirement to conduct excursion monitoring during the stability monitoring period is inconsistent with NRC license requirements. Section 6.1.8.1 of the approved NRC license application indicates that excursion monitoring will occur during active restoration, which does not include the stability monitoring period. Since the groundwater would have been restored and no injection would occur into the wellfield during stability monitoring, there is no nexus for an excursion to occur. The current language is also inconsistent with Section 9.2 (page 95) of the Fact Sheet, which indicates that "Groundwater level measurements must be recorded ... every 60 days during</p>





Table 1. Draft Class III Area Permit Specific Comments and Recommended Permit Language Revisions (cont.)

No.	Page	Recommended Alternative Language or Other Modification	Explanation of Alternative(s)	Comment				
				groundwater restoration” (with no mention of stability monitoring).				
53	59	<p><b>Table 14. Monitoring Parameters and Frequency</b></p> <table border="1"> <tr> <td colspan="2"><b>G. QUARTERLY</b></td> </tr> <tr> <td>ANALYZE</td> <td> <p>Samples from operational monitoring stock wells within permit area for chloride, total alkalinity, and specific conductance</p> <p>Samples from <del>domestic wells and</del> operational monitoring wells listed in Table 16 for baseline parameters (Table 8)</p> </td> </tr> </table>	<b>G. QUARTERLY</b>		ANALYZE	<p>Samples from operational monitoring stock wells within permit area for chloride, total alkalinity, and specific conductance</p> <p>Samples from <del>domestic wells and</del> operational monitoring wells listed in Table 16 for baseline parameters (Table 8)</p>	As described in comment #49, Powertech requests removal of monitoring requirements in Table 14G that are duplicative of NRC monitoring requirements, including those for stock wells and operational monitoring wells.	The table specifies that samples from domestic wells and operational monitoring wells must be analyzed for the Table 8 list of baseline parameters. As described in comment #16, the Table 8 list of parameters is inconsistent with NRC license requirements, specifically with Table 6.1-1 of the approved NRC license application. Powertech requests removing domestic wells from the quarterly sampling table. Consistent with Section 5.7.8.2 of the approved NRC license application, domestic wells are sampled annually.
<b>G. QUARTERLY</b>								
ANALYZE	<p>Samples from operational monitoring stock wells within permit area for chloride, total alkalinity, and specific conductance</p> <p>Samples from <del>domestic wells and</del> operational monitoring wells listed in Table 16 for baseline parameters (Table 8)</p>							
60	65	<b>Figure 9. Operational Monitoring Wells - Stock Wells</b>	Powertech requests correcting the internal inconsistency regarding whether Well 41 is a stock or domestic well. Figure 5 in the Aquifer Exemption ROD should be corrected to depict Well 41 as a stock well.	The figure depicts Well 41 as a stock well, but Figure 5 in the draft Aquifer Exemption ROD depicts it as a domestic well. Section 4.2.1 of the Fact Sheet (page 31) describes how this is now a stock watering well located at an uninhabitable residence. This residence has not been inhabited since before Powertech has worked on the property and is believed to have been uninhabited for at least 30 years or more. It is currently in a state of disrepair which would not allow use by the residence.				
61	69	<b>IX.C. Excursion Monitoring</b> <b>2. During Groundwater Restoration and Stability Monitoring</b>	Powertech requests removing “and Stability	See comment #51, which describes how the approved NRC license				





Table 1. Draft Class III Area Permit Specific Comments and Recommended Permit Language Revisions (cont.)

No.	Page	Recommended Alternative Language or Other Modification	Explanation of Alternative(s)	Comment
			Monitoring” for consistency with NRC license requirements. See also comment #51.	application requires excursion monitoring during active restoration but not stability monitoring.
62	70	<p><b>IX.C. Excursion Monitoring</b></p> <p><b>3. During a Confirmed Excursion Event</b></p> <p><del>c. Monitoring Nearest Unimpacted Wellfield Perimeter Monitoring Wells: For injection zone excursions impacting wellfield perimeter monitoring wells, the nearest injection interval wellfield perimeter monitoring wells on each side of the impacted well(s) that have not been impacted by the excursion shall also be monitored weekly according to a and b above to verify that the excursion plume is not expanding.</del></p>	Powertech requests removing section 3.c. excursion monitoring requirements because the additional requirements are inconsistent or duplicative with the NRC license. Powertech requests EPA leave all matters of excursion monitoring and control to NRC, who retains the regulatory authority on this matter. However, if the EPA does not satisfy this request, Powertech requests these edits be made.	<p>The excursion monitoring and corrective action program reviewed and approved by NRC is a proven method of detecting excursions and will provide timely detection and correction of a potential expanding excursion plume, without the need for additional monitoring requirements or corrective actions.</p> <p>Refer to Attachment A-7 of the Original EPA Letter, which includes comments related to the proposed monitoring requirements and corrective actions for an “expanding excursion plume.” Specifically, comment A-7-10 describes how standard excursion monitoring procedures include sampling all perimeter monitoring wells every 2 weeks, which will allow Powertech to make a timely determination whether an expanding excursion plume exists.</p>





Table 1. Draft Class III Area Permit Specific Comments and Recommended Permit Language Revisions (cont.)

No.	Page	Recommended Alternative Language or Other Modification	Explanation of Alternative(s)	Comment
63	70	<p><b>Part IX, Section C. Excursion Monitoring</b>            4. During a Confirmed Excursion Event            d. Criteria for Expanding Excursion Plume:            ii. <del>———— If groundwater sample analyses in a non-injection interval monitoring well show increasing concentrations in excursion parameters during four consecutive sampling periods or an existing non-injection interval excursion expands to an adjacent unimpacted monitoring well.</del></p> <p><b>Part IX, Section C. Excursion Monitoring</b>            4. During a Confirmed Excursion Events            f. Additional Requirements for Expanding Excursion Plumes            i. For excursions detected in non-injection interval monitoring wells <del>that 1) show excursion parameter concentrations increasing for four consecutive weeks or 2) if an excursion plume in a non-injection interval expands to include an adjacent non-injection interval monitoring well</del>, in addition to the monitoring required under <del>3a and 3b</del> 4a and 4b above, the Permittee shall collect a groundwater sample from the impacted well(s) and analyze the sample(s) for the baseline parameters in Table 8.            ii. For expanding excursions detected in the injection interval <del>that 1) show excursion parameter concentrations increasing for four consecutive weeks or 2) the expanding excursion plume expands further to impact adjacent wellfield perimeter monitoring wells</del>, the Permittee shall collect a groundwater sample from the impacted well(s) and analyze the sample(s) for the baseline parameters in Table 8.</p>	<p>Powertech requests removing Section 4.d excursion monitoring requirements because the additional requirements are inconsistent or duplicative with the NRC license. Powertech requests EPA leave all matters of excursion monitoring and control to NRC who retains the regulatory authority on this matter. However, if the EPA does not satisfy this request, Powertech requests these edits be made.</p> <p>Powertech requests removal of condition 4.d.ii, since the criteria for an expanding excursion plume is adequately defined in d.i of this Part.</p> <p>Powertech requests revising the requirements in 4.f.1 and 4.f.ii for consistency with 4.d.ii.</p>	<p>The excursion monitoring and corrective action program reviewed and approved by NRC is a proven method of detecting excursions and will provide timely detection and correction of a potential expanding excursion plume, without the need for additional monitoring requirements or corrective actions.</p> <p>Refer to Attachment A-7 of the Original EPA Letter, which includes comments related to the proposed monitoring requirements and corrective actions for an “expanding excursion plume.” Specifically, comment A-7-10 describes how standard excursion monitoring procedures include sampling all perimeter monitoring wells every 2 weeks, which will allow Powertech to make a timely determination whether an expanding excursion plume exists.</p>
65, 66	71	<del>5. Geochemical Modeling for Expanding Excursion Plumes</del>	Powertech requests removing additional	The excursion monitoring and corrective action program





Table 1. Draft Class III Area Permit Specific Comments and Recommended Permit Language Revisions (cont.)

No.	Page	Recommended Alternative Language or Other Modification	Explanation of Alternative(s)	Comment
		<p><del>a. If concentrations of excursion parameters increase for four consecutive weeks or if an expanding plume expands further to include an adjacent monitoring well, then the Permittee shall update the Conceptual Site Model with the excursion information and develop a reactive transport model to evaluate the characteristics and potential extent of the expanding excursion plume and to evaluate the potential of the excursion plume to cross the aquifer exemption boundary and impact down-gradient USDWs.</del></p> <p><del>b. The Conceptual Site Model shall be updated with all available information list in Part IV, Section A.1 for the non-injection interval aquifer impacted by the expanding plume.</del></p> <p><del>c. The reactive transport model shall:</del></p> <p><del>i. Be calibrated to flow and geochemical conditions present at the excursion site and excursion parameter concentrations measured in the monitoring well(s);</del></p> <p><del>ii. Evaluate the extent of the excursion plume;</del></p> <p><del>iii. Determine the potential for the excursion plume to reach the aquifer exemption boundary at the current rate of expansion; and</del></p> <p><del>iv. Estimate the concentrations of ISR contaminants at the aquifer exemption boundary, taking into account the effects of dispersion and natural attenuation based on the geochemistry of the aquifer unit.</del></p> <p><del>d. After reviewing the model results, the Director will determine what actions the Permittee should take to protect USDWs, including the installation of additional monitoring wells and aquifer remediation, if needed.</del></p> <p><b>6. Requirement to Remediate Excursions</b></p> <p>The Permittee must implement corrective action for an excursion and continue excursion monitoring at all impacted monitoring wells until the excursion parameter concentrations meet non-excursion levels for four consecutive monitoring periods in all impacted monitoring wells. Non-excursion levels means no single excursion parameter exceeds 20% of its UCL and no two excursion parameters exceed their respective UCLs in any monitoring well.</p>	<p>monitoring requirements for excursions because the additional requirements are inconsistent or duplicative with the NRC license. Powertech requests EPA leave all matters of excursion monitoring and control to NRC who retains the regulatory authority on this matter.</p>	<p>reviewed and approved by NRC is a proven method of detecting excursions and will provide timely detection and correction of a potential expanding excursion plume, without the need for additional monitoring requirements or corrective actions.</p>





Table 1. Draft Class III Area Permit Specific Comments and Recommended Permit Language Revisions (cont.)

No.	Page	Recommended Alternative Language or Other Modification	Explanation of Alternative(s)	Comment
80 – New Comment	28	<p><b>Part III, Section B. Wellfield Delineation Drilling and Pump Testing</b></p> <p><del>6.If vertical excursion cannot be controlled in the area around a breach that cannot be located or remediated with corrective action because operational controls are not effective, the Permittee shall be prohibited from injection activity in this location.</del></p> <p><del>7.The Permittee shall remediate any vertical excursions that have occurred in the area around a breach that cannot be located or remediated.</del></p> <p><del>8.Excursion monitoring shall continue in the area where around a breach that cannot be located or remediated with corrective action even though there is no longer any injection activity occurring.</del></p>	Powertech requests removal of conditions 6 through 8. These requirements relate to vertical excursions, which are discussed in Part IX, Section C. Excursion monitoring is required during ISR operations and groundwater restoration but not during wellfield delineation drilling and pump testing. These conditions are not consistent with the NRC license.	
81 – New Comment	29	<p><b>PART IV. REQUIREMENTS FOR DEVELOPMENT OF A CONCEPTUAL SITE MODEL AND A REACTIVE TRANSPORT GEOCHEMICAL MODEL</b></p>	As discussed in the introduction of this submission and noted in General Comment #G-17, Powertech requests Part IV of the Revised Draft Class III Permit be revised to remove requirements that are directly derived from the proposed CADMUS requirements and replace these with requirements that are fully consistent with NRC requirements and existing regulations applicable to uranium ISR operations in the USA, as was contemplated in the Closure Plan in its Proposed Alternate Solution to Post-Restoration Groundwater Monitoring, Attachment A-3, of Powertech’s Original EPA Letter. As evidenced by the October 30, 2018 withdrawal of EPA’s proposed rulemaking on 40 CFR Part 192, these requirements are already satisfied by the regulatory program in place by the NRC. The EPA should remove requirements not consistent with those of the NRC. Powertech would further add that requirements under the Safe Drinking Water Act are fully met by the NRC regulatory program, which fully addresses any endangerment to human health and environmental safety as required under 10 CFR Part 40, Appendix A, Criteria 5B(5) and 5B(6) (see G-9, G-10 in the Original EPA Letter). A groundwater model is not required by NRC to demonstrate successful protection outside the aquifer exemption boundary, which by	







Table 1. Draft Class III Area Permit Specific Comments and Recommended Permit Language Revisions (cont.)

No.	Page	Recommended Alternative Language or Other Modification	Explanation of Alternative(s)	Comment
			regulation is satisfied by successful groundwater restoration to drinking water standards, Commission-approved background, or by application for an ACL. While an ACL application may demonstrate environmental protection outside the aquifer exemption boundary with a geochemical model, it is not the only means for satisfying this requirement. EPA's use of 40 CFR §144.12(a) to promulgate the unprecedented requirements in this section is unjustified and without any presented basis for endangerment that may result in such system's not complying with any national primary drinking water regulation or may otherwise adversely affect the health of persons as required under 42 U.S.C. § 300h(b)(1)(B)9d) (2) (see comment G-4 in Original EPA Letter). Powertech requests that the geochemical model be revised to a single model at the end of each major wellfield area (i.e., one geochemical model for the Dewey area and one geochemical model for the Burdock area) following completion of stability monitoring for each major wellfield area. Powertech requests that EPA limit the constituents of the geochemical model to one or two constituents of concern or to those contained in an ACL application, if such is used by the applicant to satisfy NRC requirements for groundwater restoration. See also comments #109 through 134 for specific changes requested to Part IV.	
82 – New Comment	45	<b>Part V, Section G</b> 7. The Permittee shall indicate the MAIP determined for the injection well in accordance with Section F.7 of this Part in the construction report.	Internal inconsistency	Part V, Section G.7 should be consistent with Part V, Section F.7, which states that the well construction report shall contain "The MAIP determined for the injection well based on requirement 6 above."
83 – New Comment	51	<b>Part VI, Section A. Requirements for Well Stimulation, Workovers and Alterations</b> 5. A successful demonstration of internal mechanical integrity is required following the completion of any well workover or alteration which affects the integrity of the casing, packer or	Inconsistent with NRC license requirements	Powertech requests removal of the requirement to obtain written approval from the Director for a successful MIT following well stimulation, workover or





Table 1. Draft Class III Area Permit Specific Comments and Recommended Permit Language Revisions (cont.)

No.	Page	Recommended Alternative Language or Other Modification	Explanation of Alternative(s)	Comment
		tubing. Documentation of mechanical integrity test results shall be included in the next Quarterly Monitoring Report, or sooner if the Permittee chooses. Injection operations shall not be resumed until the well has successfully demonstrated mechanical integrity <del>and the Director has provided written approval to resume injection.</del>		alteration. Requiring such written approval before resuming operations is inconsistent with License Condition 10.5 of SUA-1600. If the well passes MIT, Powertech should have the capability of injecting into the well immediately, in conformance with the approved NRC license.
84 – New Comment	51	<b>Part VI, Section A. Requirements for Well Stimulation, Workovers and Alterations</b> <del>6. If an acidizing operation is conducted on well perforations, then the Permittee shall demonstrate the integrity of cement above the well screen or open hole has not been compromised by exposure to the acid. Documentation of this demonstration shall be included in the next Quarterly Monitoring Report.</del>	Powertech requests removal of this condition, since fluid flow is horizontal not vertical and due to the small volume of acid used for well stimulations. The acid largely would be consumed by precipitates and natural formation buffering. It is also impossible to demonstrate the integrity of the cement for PVC casing.	
85 – New Comment	51	<b>Well Workover or Alteration</b> 3. Documentation of mechanical integrity test results shall be included in the next Quarterly Monitoring Report, <del>or sooner if the Permittee chooses. if the Permittee would like to recommence injection into the well sooner, the documentation of mechanical integrity test results may be submitted immediately to the Director.</del>	Inconsistent with NRC license requirements	See Comment #83. The requirement to obtain Director approval prior to injection for a well that successfully passes MIT is inconsistent with License Condition 10.5 of SUA-1600. If the well passes MIT, Powertech should have the capability of injecting into the well immediately, in conformance with the approved NRC license.
86 – New Comment	51	<b>Part VI, Section B. Demonstration of Well Mechanical Integrity after Well Workover or Alteration</b> <del>4. If the workover is being conducted because of mechanical integrity loss, the Permittee shall not resume injection until the Director has provided written approval.</del>	Inconsistent with NRC license requirements	Powertech requests removal of this condition. See Comment #83.
87 – New Comment	51	<b>Part VII, Section B. Requirement to Demonstrate and Maintain Mechanical Integrity</b>	Inconsistent with NRC license requirements	Powertech requests removal of the requirement to receive written authorization from the Director for





**Table 1. Draft Class III Area Permit Specific Comments and Recommended Permit Language Revisions (cont.)**

No.	Page	Recommended Alternative Language or Other Modification	Explanation of Alternative(s)	Comment		
		<del>4. The Permittee must receive written authorization from the Director prior to commencing operation of additional wells.</del>		a successful MIT prior to commencing operation of injection and production wells constructed after the Authorization to Commence Injection is issued. The requirement to obtain Director approval for wells that successfully pass MIT is inconsistent with License Condition 10.5 of SUA-1600. If the well passes MIT, Powertech should have the capability of operating the well immediately, in conformance with the approved NRC license. See Comment #83.		
88 – New Comment	53	<b>Part VI, Section G. Ongoing Demonstration of Mechanical Integrity</b> 5. Demonstration of Mechanical Integrity after Well Workovers In addition to these regularly scheduled demonstrations of mechanical integrity, the Permittee shall demonstrate internal mechanical integrity following any workover that affects the integrity of the casing or cement of any injection or production wells within a wellfield as required under Part VI, Section B. <del>The Permittee shall not resume injection after a well workover until the Director has issued writing approval to resume injection.</del>	Inconsistent with NRC license requirements	See Comment #83. The requirement to obtain Director approval prior to injection for a well that successfully passes MIT is inconsistent with License Condition 10.5 of SUA-1600. If the well passes MIT, Powertech should have the capability of injecting into the well immediately, in conformance with the approved NRC license.		
89 - New Comment	59	<b>Table F. 60 Day Interval Excursion Monitoring During Groundwater Restoration and Stability Monitoring</b>	Inconsistent with NRC license requirements	See Comment #51 above		
90 - New Comment	59	<b>Table G. Quarterly</b> <table border="1" data-bbox="451 1230 1178 1356"> <tr> <td data-bbox="451 1230 592 1356">ANALYZE</td> <td data-bbox="592 1230 1178 1356">Samples from operational monitoring stock wells within permit area for chloride, total alkalinity, and specific conductance</td> </tr> </table>	ANALYZE	Samples from operational monitoring stock wells within permit area for chloride, total alkalinity, and specific conductance	Inconsistent with NRC license requirements	See Comment #53 above
ANALYZE	Samples from operational monitoring stock wells within permit area for chloride, total alkalinity, and specific conductance					





**Table 1. Draft Class III Area Permit Specific Comments and Recommended Permit Language Revisions (cont.)**

No.	Page	Recommended Alternative Language or Other Modification		Explanation of Alternative(s)	Comment		
			Samples from <del>domestic wells and</del> operational monitoring wells listed in Table 16 for baseline parameters (Table 8)				
91 - New Comment	61	<b>Part IX, Section B. Monitoring Parameters, Frequency, Records and Reports</b> 2. Determining Baseline Water Quality The Permittee shall determine <del>baseline water quality</del> Commission-approved background groundwater quality data for the ore zone, overlying aquifers, underlying aquifers, alluvial aquifers (where present), and the perimeter monitoring areas according to the requirements under Section 11.3 Establishment of Commission-Approved Background Water Quality in the NRC Source Material License.			Typographical correction.		
92 - New Comment	61	<b>Part IX, Section B. Monitoring Parameters, Frequency, Records and Reports</b> 3. Operational Groundwater Monitoring a. Domestic Wells i. During operations, the Permittee shall monitor all downgradient domestic wells <del>within</del> 1.2 miles of the boundary of each wellfield (as measured from the perimeter monitoring well ring), unless the well owners do not consent to sampling or the condition of the wells renders a well unsuitable for sampling.			Typographical correction.		
93 - New Comment	61	<b>Part IX, Section B. Monitoring Parameters, Frequency, Records and Reports</b> 3. Operational Groundwater Monitoring a. Domestic Wells iii. Samples shall be collected <del>quarterly</del> <del>annually</del> and analyzed for the baseline parameters listed in Table 8.		Inconsistent with NRC license requirements	Powertech requests revising "quarterly" to "annually" for consistency with Section 5.7.8.2 of the approved NRC license application. See Comment #43.		
94 - New Comment	61	<b>Table H. 24-Hour Reporting</b> <table border="1" style="width: 100%;"> <tr> <td style="width: 20%;">REPORT</td> <td><del>Any noncompliance which may endanger human health or the environment, including:</del></td> </tr> </table>		REPORT	<del>Any noncompliance which may endanger human health or the environment, including:</del>	Inconsistent with NRC license requirements	Powertech requests removal of this statement in this table.  Powertech would be required to make a nearly immediate determination of what "may cause
REPORT	<del>Any noncompliance which may endanger human health or the environment, including:</del>						





Table 1. Draft Class III Area Permit Specific Comments and Recommended Permit Language Revisions (cont.)

No.	Page	Recommended Alternative Language or Other Modification	Explanation of Alternative(s)	Comment
		<p><del>Any monitoring or other information which indicates that any contaminant may cause endangerment to a USDW; or</del></p> <p><del>Any noncompliance with a permit condition or malfunction of the injection system which may cause fluid migration into or between USDWs.</del></p>		<p>fluid migration into a USDW" and "endangerment to a USDW" despite the fact such a determination is under the authority of the NRC. Further, as written, Powertech would be in violation of its permit for not reporting within 24 hours any event which could cause these possible outcomes, even if such an event is outside of the detection of the monitoring systems and the controls put in place by this permit. The vagueness of the condition means that the permittee could be in violation for untimely reporting even if all other conditions of the permit are followed. Such a condition is also excessive and unclear, as "non-compliance" here is not explained and as written, this could potentially make the reporting requirement not limited to requirements beyond this permit. It would imply that any information" and "malfunction of injection system" are unspecific and not explained elsewhere in this permit. For example, if a light bulb burned out inside a header house, this could be considered a malfunction of an injection system requiring 24-hour reporting. Powertech believes such a condition, as written, is unrealistic.</p>



Table 1. Draft Class III Area Permit Specific Comments and Recommended Permit Language Revisions (cont.)

No.	Page	Recommended Alternative Language or Other Modification	Explanation of Alternative(s)	Comment
				Furthermore, Powertech believes such a condition is inconsistent with other similar UIC permits and outside of existing regulations.
95 - New Comment	69	<p><b>Part IX, Section B. Monitoring Parameters, Frequency, Records and Reports</b></p> <p><del>3.4.</del> Monitoring Records Must Include:</p> <ul style="list-style-type: none"> <li>a. Chain of Custody for fluids samples</li> <li>b. The date, exact place, and time of sampling or measurements;</li> <li>c. The individual(s) who performed the sampling or measurements;</li> <li>d. The date(s) analyses were performed;</li> <li>e. The individual(s) who performed the analyses;</li> <li>f. The analytical techniques or methods used; and</li> <li>g. The results of such analyses.</li> </ul>		Typographical correction.
96 - New Comment	69	<p><b>Part IX, Section C. Excursion Monitoring</b></p> <p>2. During Groundwater Restoration <del>and Stability Monitoring</del></p>	<p>Powertech requests removing section C. Excursion Monitoring requirements because the additional requirements are inconsistent or duplicative with the NRC license. Powertech requests EPA leave all matters of excursion monitoring and control to NRC who retains the regulatory authority on this matter. However, if the EPA does not satisfy this request, Powertech requests these edits be made.</p>	<p>Powertech requests removing “and Stability Monitoring” for consistency with NRC license requirements. See Comment #51 and #89.</p>
97 - New Comment	70	<p><b>Part IX, Section C. Excursion Monitoring</b></p> <p>4. During a Confirmed Excursion Event</p>	<p>Powertech requests removing Section C</p>	<p>Powertech requests revising the condition for consistency with</p>





Table 1. Draft Class III Area Permit Specific Comments and Recommended Permit Language Revisions (cont.)

No.	Page	Recommended Alternative Language or Other Modification	Explanation of Alternative(s)	Comment
		<p>d. Criteria for Expanding Excursion Plume:</p> <p>i. If groundwater sample analyses from either an adjacent unimpacted wellfield perimeter monitoring well or a non-injection interval <b>monitoring well</b> begin to show concentrations of any two excursion indicator parameters that exceed their respective UCL, as established under the NRC License, or any one excursion indicator parameter exceeds its UCL by 20 percent, the excursion criterion is exceeded and the excursion is now considered to be an expanding excursion plume.</p>	<p>excursion monitoring requirements because the additional requirements are inconsistent or duplicative with the NRC license. Powertech requests EPA leave all matters of excursion monitoring and control to NRC, who retains the regulatory authority on this matter. However, if the EPA does not satisfy this request, Powertech requests these edits be made.</p>	<p>other uses of “non-injection interval monitoring well” and to clarify that in order to be considered an expanding excursion plume, an excursion would need to be detected in an adjacent, unimpacted well, not just any non-injection interval monitoring well.</p>
98 – New Comment	70	<p><b>Part IX, Section C. Excursion Monitoring</b></p> <p>4. During a Confirmed Excursion Event</p> <p>d. Criteria for Expanding Excursion Plume:</p> <p><del>ii. If groundwater sample analyses in a non-injection interval monitoring well show increasing concentrations in excursion parameters during four consecutive sampling periods or an existing non-injection interval excursion expands to an adjacent unimpacted monitoring well.</del></p>	<p>Powertech requests removing Section C excursion monitoring requirements because the additional requirements are inconsistent or duplicative with the NRC license. Powertech requests EPA leave all matters of excursion monitoring and control to NRC who retains the regulatory authority on this matter. However, if the EPA does not satisfy this request, Powertech</p>	<p>Powertech requests removal of this condition, since the criteria for an expanding excursion plume is adequately defined d.i of this Part.</p>





Table 1. Draft Class III Area Permit Specific Comments and Recommended Permit Language Revisions (cont.)

No.	Page	Recommended Alternative Language or Other Modification	Explanation of Alternative(s)	Comment
			requests these edits be made.	
99 – New Comment	70	<p><b>Part IX, Section C. Excursion Monitoring</b></p> <p>4. During a Confirmed Excursion Events</p> <p>f. Additional Requirements for Expanding Excursion Plumes</p> <p>i. For excursions detected in non-injection interval monitoring wells <del>that 1) show excursion parameter concentrations increasing for four consecutive weeks or 2) if an excursion plume in a non-injection interval expands to include an adjacent non-injection interval monitoring well</del>, in addition to the monitoring required under <del>3a and 3b</del> 4a and 4b above, the Permittee shall collect a groundwater sample from the impacted well(s) and analyze the sample(s) for the baseline parameters in Table 8.</p> <p>ii. For expanding excursions detected in the injection interval <del>that 1) show excursion parameter concentrations increasing for four consecutive weeks or 2) the expanding excursion plume expands further to impact adjacent wellfield perimeter monitoring wells</del>, the Permittee shall collect a groundwater sample from the impacted well(s) and analyze the sample(s) for the baseline parameters in Table 8.</p>	<p>Powertech requests removing Section C excursion monitoring requirements because the additional requirements are inconsistent or duplicative with the NRC license. Powertech requests EPA leave all matters of excursion monitoring and control to NRC who retains the regulatory authority on this matter. However, if the EPA does not satisfy this request, Powertech requests these edits be made.</p>	<p>Powertech requests revising these requirements for consistency with Comment # 98.</p>
100 – New Comment	72-73	<p><b>Part IX, Section E. Reporting Requirements</b></p> <p>4. Injection, Production and Monitoring Well Completion Reports</p> <p><del>a.d.</del> After an injection, production or monitoring well has been completed, the Permittee shall submit a well completion report including the information in EPA Form 7520-9 Completion Form for Injection Wells with attachments.</p> <p><del>b.e.</del> The report may be in electronic format including the completion information for a number of wells. The EPA Form 7520-9 can be found at <a href="http://water.epa.gov/type/groundwater/uic/reportingforms.cfm">http://water.epa.gov/type/groundwater/uic/reportingforms.cfm</a>.</p> <p><del>c.f.</del> The well construction report shall also contain the manufacturer-specified maximum operating pressure for all components of the injection or production well.</p>		<p>Typographical correction.</p>







Table 1. Draft Class III Area Permit Specific Comments and Recommended Permit Language Revisions (cont.)

No.	Page	Recommended Alternative Language or Other Modification	Explanation of Alternative(s)	Comment
		<p><del>d.g.</del> The cementing procedure shall be documented in detail in each well completion report.</p> <p><del>e.h.</del> Remedial cementing may be required if the Director determines the well cementing record is not adequate for demonstration of external mechanical integrity.</p> <p><del>f.i.</del> Injection well completion reports shall be submitted to the Director with the next scheduled Quarterly Monitoring Report, unless well construction was completed within 45 days of the next Quarterly Monitoring Report due date.</p> <p><del>g.j.</del> If well construction was completed within 45 days of the next Quarterly Monitoring Report due date, the well completion report shall be submitted with the following Quarterly Monitoring Report.</p>		
101 – New Comment	75	<p><b>Part IX, Section E. Reporting Requirements</b></p> <p>9. Excursion Monitoring</p> <p>d. Reporting Increase in Concentration of Excursion Indicators in Impacted Monitoring Wells</p> <p>If concentrations of excursion parameters increase for four consecutive weeks or if an expanding plume expands further to include an adjacent monitoring well, then the Permittee shall notify the Director within 24 hours per Part XII, Section <del>D.11.e</del> <b>D.10.e</b> and, within 5 days, follow up with a written reporting that includes a discussion of the Permittee’s plans to comply with Sections C.5 and C.6 of this Part and develop a reactive transport model of the expanding excursion plume.</p>		Typographical correction, provided this section is not removed from the permit.
102 - New Comment	75	<b>Part IX, Section E.9.a</b>	Reference "per Part XII, Section D.11.e" is no longer valid as this section no longer exists. Suggest deleting this reference.	
103 - New Comment	85	<b>Part XIV, Section B.</b>	Powertech requests clarification on the basis of a 1-mile avoidance buffer for the whooping crane, rufa red-knot and northern long-eared bat and how this was determined to be protective. Such a buffer appears to be much greater than typical wildlife buffers and was formulated without basis within the documents provided. From the documents provided, it appears that the buffer was arbitrarily increased from 1/4 mi to 1 mile by EPA and applied to other species arbitrarily.	





Table 1. Draft Class III Area Permit Specific Comments and Recommended Permit Language Revisions (cont.)

No.	Page	Recommended Alternative Language or Other Modification	Explanation of Alternative(s)	Comment
				Powertech recommends that a mitigation plan be allowed to be developed upon observation of these species. Such a plan could involve various strategies to avoid a take.
104 - New Comment	85	<b>Part XIV, Section B.</b>		Powertech requests modification of the requirement that all operations and construction must cease within 1 mile upon sighting a whooping crane, rufa red-knot or northern long-eared bat. In particular, active operations cannot be immediately ceased as this could endanger protection of USDWs as operations are required to be manned. As well, this could create serious issues with compliance conditions within the Class III permit, for example, the need to continuously maintain a bleed on the wellfield. Powertech recommends that a mitigation plan be allowed to be developed upon observation of these species. Powertech questions the authority of the EPA to enforce such requirements. Such conditions are enforceable under the South Dakota DENR Large Scale Mine Permit, and Powertech believes these requirements are better applied in this fashion, with direct interaction with SD GFP, where trained wildlife biologists can determine an appropriate approach.
105 - New Comment	85	<b>Part XIV, Section B.</b> "Mitigation measure 5: If supplemental lighting is used during construction or operation, the lights must be directed and/or sheltered to minimize the amount of light escaping the work or project site."		This condition appears arbitrary and not tied to the known presence of wildlife of concern. Powertech suggests that this condition be modified so that if a whooping crane, rufa red-knot or northern long-eared bat have been confirmed at the site by trained wildlife biologist, then such a condition would be applied if deemed appropriate by a trained wildlife biologist.
106 - New Comment	85	<b>Part XIV, Section B. The Endangered Species Act (ESA), 16 U.S.C 1531 et seq.</b> Section 7 of the ESA and its implementing regulations (50 CFR part 402) require the EPA to ensure, in consultation with the Secretary of the Interior or Commerce, that any action authorized by EPA is not likely to jeopardize the continued existence of any endangered or threatened species or adversely affect its critical habitat.		From the biological assessment documents provided, it does not appear that the EPA sought specific input on the parameters of mitigation for the whooping crane and rufa red-knot prior to creating permit requirements. Powertech requests clarification on the Section 7 consultation with the Secretary of the Interior (U.S. Fish and Wildlife Service). Are the mitigation measures described in the draft permit a result of





Table 1. Draft Class III Area Permit Specific Comments and Recommended Permit Language Revisions (cont.)

No.	Page	Recommended Alternative Language or Other Modification	Explanation of Alternative(s)	Comment
				this consultation? If not, Powertech requests that this section be revised once consultation has been completed.
107 - New Comment	85	<b>Part XIV, Section B. The Endangered Species Act (ESA), 16 U.S.C. 1531 et seq.</b> 8. During the northern long-eared bat active season (April 1 to October 31), the Permittee shall use a motion-activated camera to monitor the Triangle Mine vertical ventilation shaft located at NWNW Section 35, T6S, R1E for 5 days and nights and determine if bats are entering and exiting. If no bats are observed entering or exiting the shaft, the Permittee shall investigate the shaft to determine if bats are inside the shaft. If no bats are inside the shaft, the Permittee shall cover the entrance to the shaft with finer mesh to prevent bats from entering. If bats are observed in the shaft, the Permittee shall work with South Dakota Game, Fish and Parks to evaluate methods for establishing an appropriate buffer zone around the shaft to prevent tree removal or wellfield construction activity. The buffer zone will need to take into account the fact that the shaft is only a few feet away from a road that is used by local residents and may be improved to use as an access road to the Project Site.		Powertech requests clarification on the frequency of the motion-activated camera monitoring. Powertech requests clarification that additional monitoring will not be required if the shaft entrance is covered following a determination that no bats are inside the shaft.
108 - New Comment	89	<del>APPENDIX B Cadmus Report on Acceptance Criteria for the Geochemical Model</del>		Powertech requests that all references/connections to the CADMUS documents be removed from the Class III Permit. As discussed in the introduction and General Comment #G-17, inclusion of the CADMUS documents in the Revised Draft Class III Permit is not supported. References made in Part IV of the Revised Draft Class III Permit to the CADMUS documents should be removed. Appendix B and the link to the Cadmus documents in the Revised Draft Class III permit should also be removed.
109 – New Comment	29	<b>Part IV, Section A.1.a</b> vii. Petrologic and mineralogic characteristics that can affect hydraulic and geochemical properties of the injection interval and confining zones, <del>such as grain size, cementation, overgrowths, and nodules as available.</del>	Inconsistent with NRC license requirements. The overall hydraulic properties will be measured by the pump test and thus more	See Comment #81





Table 1. Draft Class III Area Permit Specific Comments and Recommended Permit Language Revisions (cont.)

No.	Page	Recommended Alternative Language or Other Modification	Explanation of Alternative(s)	Comment
			representative of these properties.	
110 – New Comment	30	<b>Part IV, Section A.1.b</b> b. Hydrologic Properties i. For each wellfield injection interval and the first confining zones overlying and underlying the injection interval, the CSM shall include hydraulic properties as measured by pump testing. <del>but not be limited to, site-specific data concerning:</del> A) <del>Porosity;</del> B) <del>Intrinsic permeability (horizontal and vertical); and</del> C) <del>Vertical hydraulic conductivity.</del>	In accordance with the NRC license, this data is collected only by pump testing.	See Comment #81
111 – New Comment	30	<b>Part IV, Section A.1.b</b> ii. For each wellfield injection interval, the CSM also shall include site-specific data to assess <del>as available:</del>	The EPA needs to clarify that the data for the CSM should be limited to data collected under the requirements of the NRC license.	See Comment #81
112 – New Comment	30	<b>Part IV, Section A.1.b.ii</b> <del>E) Transient hydraulic head conditions during injection activities;</del>	This cannot be measured and is not consistent with NRC license requirements and may not be required to demonstrate an ACL.	See Comment #81
113 – New Comment	30	<b>Part IV, Section A.1.c.i</b> <del>D) Potential for colloid-facilitated transport of uranium and other metals. This can be assessed by separation of colloidal and dissolved uranium fractions by ultrafiltration on a subset of samples; and</del>	This requirement goes beyond the analysis required by the NRC license and should be removed as it may not be required to demonstrate an ACL.	See Comment #81
114 – New Comment	30-31	<b>Part IV, Section A.1.d</b>	Powertech requests removal of requirements A), B), D), and E) as they are not consistent with NRC requirements.	See Comment #81





Table 1. Draft Class III Area Permit Specific Comments and Recommended Permit Language Revisions (cont.)

No.	Page	Recommended Alternative Language or Other Modification	Explanation of Alternative(s)	Comment
115 – New Comment	31	<p><b>Part IV, Section A.1.d. Geochemical Processes</b></p> <p>i. To ensure important geochemical processes at the Dewey-Burdock site are represented, the CSM <del>shall</del> may include consideration of the following interactions between fluids and solids in each injection interval:</p>	<p>These requirements are not consistent with the NRC license. Further, not all of these requirements are needed for all models to assess transport across the aquifer exemption boundary and this assumes a particular 3-D transport model is generated. Powertech requests flexibility in approach as needed to appropriately address transport of contaminants.</p>	See Comment #81
116 – New Comment	31	<p><b>Part IV, Section A.1.d</b></p> <p>ii. The following geochemical processes <del>shall</del> may also be evaluated for inclusion in the CSM:</p>	<p>The requirements of this section do not account for situations where Commission-approved background or an MCL is met, or if the constituent is not of concern (i.e., no endangerment). This section stipulates requirements which may not be necessary for demonstration of transport of contaminants across the aquifer exemption boundary. Powertech requests using the word “may” to allow for</p>	See Comment #81





Table 1. Draft Class III Area Permit Specific Comments and Recommended Permit Language Revisions (cont.)

No.	Page	Recommended Alternative Language or Other Modification	Explanation of Alternative(s)	Comment
			flexibility of reasonable approaches to appropriately address this requirement.	
117 – New Comment	32	<b>Part IV, Section A.2.a</b> g. Sufficient data were collected to characterize heterogeneity and statistically represent variations in geologic, hydrologic, and geochemical conditions across the site. h. Geochemical data spatially represent the sites necessary to identify and characterize geochemical processes at the site.	Powertech requests the EPA clarify that these requirements will not exceed the NRC license requirements.	See Comment #81
118 – New Comment	32	<b>Part IV, Section A.2.a</b> <del>i. Data meet quality assurance requirements. Water quality analyses have a charge imbalance less than 10 percent.</del>	Powertech requests deletion of this requirement as it is not consistent with NRC license requirements.	See Comment #81
119 – New Comment	32	<b>Part IV, Section A.2.a</b> m. Appropriate field measurements of water-quality physical properties (pH, temperature, and <del>specific conductance dissolved oxygen, oxidation-reduction potential</del> ) were made.	Powertech requests the field parameters be made consistent with the NRC license requirements.	See comments #81 and #16
120 – New Comment	32	<b>Part IV, Section A.2.a</b> <del>n. The oxidation state of uranium, iron, manganese, and other redox sensitive metals are characterized in the solid phase. o. Iron phases in sediment are characterized. p. Geochemical processes related to uranium mobility were characterized by using laboratory or field testing.</del>	Powertech requests deletion of these requirements as they are not consistent with the NRC license requirements.	See comment #81
121 – New Comment	33	<b>Part IV, Section A.4</b> The Permittee shall provide information about updates to the Conceptual Site Model in the Quarterly Monitoring Reports <del>or certify that none of the activities listed under 3 above occurred to trigger an update, as required under Part IX, Section E.8.</del>	Powertech requests deletion of the highlighted text. These requirements are not consistent with the NRC license.	As noted previously, Powertech requests removal of excursion monitoring requirements as they are under the regulatory jurisdiction of NRC. However, if the EPA does not satisfy this request,





Table 1. Draft Class III Area Permit Specific Comments and Recommended Permit Language Revisions (cont.)

No.	Page	Recommended Alternative Language or Other Modification	Explanation of Alternative(s)	Comment
				Powertech requests these edits be made.
122 – New Comment	33	<b>Part IV, Section B</b> 1. The Permittee <del>shall</del> may incorporate the following scenarios into the geochemical model:		See comments #81 and #115
123 – New Comment	33	<b>Part IV, Section B.2</b> The ultimate objective of the geochemical model is to simulate <del>as accurately as possible</del> the fate and transport of ISR contaminants as they interact with downgradient, injection-interval geochemical conditions, <del>such that the model becomes a tool to evaluate the potential for ISR contaminants to cross the aquifer exemption boundary.</del>	Powertech requests that the text be changed so that it does not reflect an ongoing research project, but an assessment sufficient to be protective of human health and the environment. Furthermore, Powertech, in its Original EPA Letter Attachment A-3, Proposed Alternate Solution to Post-Restoration Groundwater Monitoring, only proposed to complete geochemical modeling for each major wellfield area (i.e., the Dewey area and the Burdock area only) following completion of stability. In the Revised Draft Class III Permit, these requirements go well beyond the NRC license requirements and well beyond what Powertech	See comment #81





Table 1. Draft Class III Area Permit Specific Comments and Recommended Permit Language Revisions (cont.)

No.	Page	Recommended Alternative Language or Other Modification	Explanation of Alternative(s)	Comment
			proposed in its Original EPA Letter.	
124 – New Comment	33	<p><b>Part IV, Section B.2</b>  <del>Because simulations representing long-term post-restoration conditions and transport are purely predictive and will lack field-verification of results, geochemical modeling shall be performed on an iterative basis during project phases when field and laboratory measurements can be used to calibrate the model and additional data can be collected as needed to verify simulation results.</del></p>	<p>Powertech requests the deletion of this text as it is not consistent with the NRC license requirements and it is not consistent with Attachment A-3, Proposed Alternate Solution to Post-Restoration Groundwater Monitoring in Powertech’s Original EPA Letter (a single geochemical model at the end of stability for each major wellfield area [i.e., the Dewey area and the Burdock area only]).</p>	See Comment #81
125 – New Comment	33	<p><b>Part IV, Section B.2</b>  a. The Permittee <del>shall</del> <b>may</b> conduct <del>iterative</del> modeling (batch reaction or reactive transport) for calibration and verification including representation of the following:</p>	<p>Powertech requests modification of the text to provide flexibility for alternative approaches to address the transport of contaminants across the aquifer exemption boundary. Powertech requests the deletion of text which is not consistent with NRC license requirements and not consistent with Attachment A-3, Proposed Alternate</p>	See Comment #81







Table 1. Draft Class III Area Permit Specific Comments and Recommended Permit Language Revisions (cont.)

No.	Page	Recommended Alternative Language or Other Modification	Explanation of Alternative(s)	Comment
			Solution to Post-Restoration Groundwater Monitoring in Powertech’s Original EPA Letter (a single geochemical model at the end of stability for each major wellfield area [i.e., the Dewey area and the Burdock area only]).	
126 – New Comment	33	<b>Part IV, Section B.2</b> b. <del>For constituent of concern, that present endangerment of human health, and that do not satisfy Commission-approved background, or an MCL, as determined by NRC,</del> the Permittee shall conduct predictive modeling of contaminant transport for site closure that includes the following: i. Reactive transport of post-restoration fluids in the wellfield downgradient toward the aquifer exemption	Powertech requests modification of text which is not consistent with the requirements of 10 CFR Part 40, Appendix A, Criterion 5.	See comment #81
127 – New Comment	34	<b>Part IV, Section B.2</b> Powertech requests deletion of Sections e and f.	Powertech requests the deletion of text which is not consistent with standard NRC license requirements and goes well beyond data requirements of the current NRC license for the Dewey-Burdock Project.	See comment #81
128 – New Comment	34	<b>Part IV, Section B.4</b> <del>4. Equilibrium, Kinetic, and Sorption Data</del>  a. <del>The thermodynamic data used by the modeling program shall contain the most up-to-date information available on uranium and other constituents of concern at the site, such as those presented</del>	Powertech requests the deletion of this section which is not consistent with standard NRC license requirements and goes well beyond data requirements of the	See comment #81





Table 1. Draft Class III Area Permit Specific Comments and Recommended Permit Language Revisions (cont.)

No.	Page	Recommended Alternative Language or Other Modification	Explanation of Alternative(s)	Comment
		<p><del>by Guillaumont et al. (2003), Dong and Brooks (2006), and Muhr-Ebert et al. (2019).</del></p> <p><del>b. Where important reactions or kinetics are not included in the model's thermodynamic database, the databases shall be augmented with site-specific data from laboratory and field studies as described in Part IV, Section C.</del></p> <p><del>c. The basis of the modeling program's thermodynamic database shall be noted, along with any data that are edited/updated for this modeling effort, including the source of the data added. Limitations and uncertainties associated with the thermodynamic database shall be noted, including any constituents controlled by species that are not included in the database.</del></p> <p><del>d. The activity coefficient model used to simulate reactions shall be chosen based on the range of ionic strengths and groundwater constituents measured in baseline groundwater, lixiviant, restoration fluid, and expected post-restoration groundwater.</del></p>	<p>current NRC license for the Dewey-Burdock Project.</p>	
129 – New Comment	34	<p><b>Part IV, Section B</b></p> <p>5. Model calibration</p> <p><del>When applicable, to reduce model prediction uncertainty concerning the long-term fate and transport of ISR contamination at the Dewey-Burdock site, the model shall be iteratively calibrated as follows:</del></p>	<p>Powertech requests modification of text to reflect a single model at the end of each major wellfield area (i.e., one geochemical model for the Dewey area and one geochemical model for the Burdock area) following completion of stability monitoring for each major wellfield area. Furthermore, it may not be necessary or possible to calibrate all components of a</p>	See Comment #81





Table 1. Draft Class III Area Permit Specific Comments and Recommended Permit Language Revisions (cont.)

No.	Page	Recommended Alternative Language or Other Modification	Explanation of Alternative(s)	Comment
			geochemical model and thus the text should be modified accordingly.	
130 – New Comment	35	<p><b>Part IV, Section B</b></p> <p>6. Uncertainty Analysis</p> <p>Uncertainty analysis shall attempt to quantify prediction uncertainty concerning the long-term fate and transport of ISR contamination at the Dewey-Burdock site <del>This may include forward Monte Carlo simulations, inverse modeling, or other methods but at a minimum shall and may</del> include the following:</p> <p>a. Sensitivity analyses for <del>all</del> geochemical parameters <del>that could have a substantial effect on simulation results, such as pH, pe, alkalinity, groundwater flow rate, effective porosity, and the quantity or concentration of calcite, pyrite, iron, carbon dioxide, and organic carbon concentrations.</del></p>	Powertech requests modification of the text to remove overly prescriptive language concerning the types of analysis and sensitivity analyses, which may not be used as they may not be deemed necessary.	See Comment #81
131 – New Comment	35-37	<p><b>Part IV, Section C</b></p> <p>Powertech requests removal of Sections 1, 2, and 3.</p>	Powertech requests removal of these requirements as they are not consistent with the data collection requirements under the NRC license. Powertech requests clarification that EPA Injection Authorization is not to be based on any information or analysis for the CSM or geochemical model and only based on the data provided in Part VII, Section C.	See Comment #81
132 – New Comment	37	<p><b>Part IV, Section D.1</b></p> <p>Powertech requests removal of requirements under Sections a, b, and c.</p>	Powertech requests modification of text to reflect a single model at	See Comment #81





Table 1. Draft Class III Area Permit Specific Comments and Recommended Permit Language Revisions (cont.)

No.	Page	Recommended Alternative Language or Other Modification	Explanation of Alternative(s)	Comment
			the end of each major wellfield area (i.e., one geochemical model for the Dewey area and one geochemical model for the Burdock area) following completion of stability monitoring for each major wellfield area and not an ongoing iterative modeling exercise.	
133 – New Comment	32	<p><b>Part IV, Section A</b></p> <p>3. The Permittee shall update the CSM when any of the following occur:</p> <p>a. On the basis of additional data collected during the development of each new wellfield. This iterative process will support identifying and filling data gaps over time and facilitate model calibration to observed conditions when the Permittee identifies data gaps or uncertainty concerning geology, hydrologic properties, geochemical characteristics, and/or geochemical processes that could affect mobility and transport of uranium and other metals at the Dewey-Burdock site, the Director may require the Permittee to develop more than one CSM to accommodate and characterize the areas of uncertainty.</p>	<p>Powertech requests that EPA clarify what is meant by “the Director may require the Permittee to develop more than one CSM to accommodate and characterize the areas of uncertainty.” Powertech understands the CSM represents data collection in advance of later geochemical modeling. However, in the above statement it appears that the CSM is some form of a modeling scenario. As requested in its Original EPA Letter Attachment A-3, Proposed Alternate Solution to Post-Restoration Groundwater Monitoring, a single model at the end of each major wellfield area (i.e., one geochemical model for the Dewey area and one geochemical model for the Burdock area) following completion of stability monitoring for each major wellfield area should be used. Requiring an iterative model that runs prior to completion of stability goes well beyond the NRC license requirements and is potentially cost prohibitive.</p>	
134 – New Comment	37	<p><b>Part IV, Section D.1.g</b></p> <p><del>The Permittee shall amend the Wellfield Closure Plan with the ACL analysis and submit it to the Director for review and approval at approximately the same time the License Amendment application is submitted to the NRC for approval of the ACL.</del></p>	Inconsistent with NRC license requirements	The EPA does not have the regulatory authority to approve ACLs for groundwater restoration of an ISR site; this is the domain of the NRC. Powertech requests removal of this requirement which





**Table 1. Draft Class III Area Permit Specific Comments and Recommended Permit Language Revisions (cont.)**

<b>No.</b>	<b>Page</b>	<b>Recommended Alternative Language or Other Modification</b>	<b>Explanation of Alternative(s)</b>	<b>Comment</b>
				creates a duplicative approval process for an ACL application.



**Table 3. Draft Aquifer Exemption Record of Decision Specific Comments**

No.	Draft AE ROD		Fact Sheet		Type	Comment and Requested Modification
	Page	Section	Page	Section		
E4	5	Regulatory Criteria for AE Request	---	---	T	In the last paragraph, 2 <sup>nd</sup> sentence, Powertech requests correcting a typographical error as follows: "As described in the September <del>2011</del> 2012 memorandum." This requested change also applies to the footnote: Technical Memorandum to J. Mays, R. Blubaugh - Powertech Uranium, from: Hal Demuth – Petrotek "Calculation of the Proposed Aquifer Exemption Distance beyond the Monitor Ring: Dewey-Burdock ISR Uranium Project, South Dakota" September 12, <del>2011</del> 2012, included as Appendix M of the Class III Permit Application.
E6	8 12-15	Fig. 3 Flow Rates Used in the Capture Zone Equation	30	4.2.1	C	Powertech disagrees with the identification of Well 41 as a drinking water well (e.g., in Figure 3 and Table 3). As described in comment #60 in Table 1, Well 41 is a stock watering well at an uninhabitable residence that has not been inhabited for 30 years or more. Powertech requests removing this well from the capture zone analysis and Figure 3 in the draft Aquifer Exemption ROD.
E7	15	40 CFR § 146.4(b)(1)	---	---	C	Powertech requests updating the reference on the commercial producibility of uranium to the most recent (2015) preliminary economic assessment for the Dewey-Burdock Project (Exhibit 026).
E8	20-21	Vertical confinement	22	3.4.2	I	Powertech requests clarifying the statement at the bottom of the page that "there is a hydraulic connection between the Fall River Formation and the Chilson Sandstone that would call into question the integrity of the Fuson Shale as an upper confining zone to the Chilson Sandstone". Specifically, Powertech requests clarifying that this statement only applies to an isolated area. As currently written, the statement could be construed as indicating a general hydraulic connection across the permit area. That is inconsistent with page 22 of the Fact Sheet, which states:  The EPA has reviewed the information that Powertech provided in the Permit Application and has determined that evidence indicates that except for the northeast corner of Section 1, T7S, R1E, the Fuson member of the Lakota formation is a continuous confining zone underlying the Fall River injection interval and overlying the Chilson Sandstone injection interval throughout the Dewey-Burdock Permit Area.
E13 – New Comment	9	Figure 5. Map of the nineteen private drinking water wells			T	Powertech suggests replacing this figure or improving the image so that the well numbers are readable. Further, Powertech requests adding items not



**Comment type key:** A – alternate approach proposed; C – correct to be consistent with application, regulations or NRC license requirements; E – additional explanation requested; I – inconsistency (internally inconsistent between parts of Draft permit or supporting documents); R – remove; inconsistent with application, regulations or NRC license requirements; T – typographical error

# Summary of Comments on Powertech Class III Comments December 9 2019.pdf

---

Page: 1

---

Number: 1 Author: vrobin03 Subject: Sticky Note Date: 10/18/2020 7:56:25 PM -06'00'

---

A comment balloon means the comment was addressed and includes the reason why.

Number: 2 Author: vrobin03 Subject: Sticky Note Date: 10/18/2020 7:56:42 PM -06'00'

---

A check mark indicates the comment was addressed.

Number: 3 Author: vrobin03 Subject: Sticky Note Date: 11/24/2020 12:52:53 PM

---

Comment #E4

EPA did not make this edit in the 2019 draft ROD. This edit was made in the final ROD.

Number: 4 Author: vrobin03 Subject: Sticky Note Date: 10/18/2020 3:48:08 PM -06'00'

---

Comment #E6

EPA provided an explanation on page 7 of the Technical Memorandum for Capture Zone Analysis as to why well 41 was treated as a drinking water wells for the purpose of the capture zone analysis. TVA noted that well 41 was formerly used as a drinking water well. EPA considered well 41 to be in the same classification as wells 16 and 43: *private wells that have been used for drinking water in the past* or as stated in the Legend for Class III Permit Application Plate 3.1 under well use: *Domestic Non-Drinking Water*

Tech Memo paragraph, page 7:

*Plate 3.1 also indicates that there is a residence located near the well and TVA records indicate that well 41 was a domestic well at some time in the past. The EPA asked Powertech to determine if there actually is a residence located near well 41 and, if so, to find out what the drinking water source for that residence is. Powertech checked the residence, found that no one was currently living in the residence and informed the EPA that the residence is uninhabitable. Powertech could not identify what the drinking water source was for the abandoned residence.*

Number: 5 Author: vrobin03 Subject: Sticky Note Date: 11/24/2020 12:53:07 PM

---

Comment #E7

EPA did not make this edit in the 2019 draft ROD. EPA updated the reference to the 2019-2020 Graves and Cutler PEA. Figure 16.3 of this document was used to justify the expanded AE area for Burdock Wellfields 1 through 5 and 9.

Number: 6 Author: vrobin03 Subject: Sticky Note Date: 11/24/2020 12:53:21 PM

---

Comment #E8

EPA did not make this edit in the 2019 draft ROD. In the final AE ROD, EPA added a paragraph to pages 19-20 providing the information in the comment and edited the paragraph referenced in the comment, now located on page 20 after Figure 7.

Number: 7 Author: vrobin03 Subject: Sticky Note Date: 10/18/2020 7:51:27 PM -06'00'

---

Comment #E13

EPA edited former Figure 5 (now Figure 4) in attempt to make the well numbers more legible and added to the legend the items not identified in former Figure 5.

**Table 3. Draft Aquifer Exemption Record of Decision Specific Comments (cont.)**

No.	Draft AE ROD		Fact Sheet		Type	Comment and Requested Modification
	Page	Section	Page	Section		
		located within approximately 2 km (1.2 miles) of the Dewey-Burdock Project Boundary.				currently identified in the legend, including wells screened in the Inyan Kara and Unkpapa aquifers.
E14 – New Comment	10	Regulatory Criteria under which the exemption is approved				The statement is made that EPA cannot make a definitive determination that well 16 does not currently supply Inyan Kara groundwater for use as drinking water for human consumption. Therefore, the EPA is seeking input on the following three options regarding the AE in the area of well 16. Powertech believes that as written option three provides a reasonable and suitable approach to address well 16.
E15- New Comment	19	<u>Project Timetable</u>			C	The proposed timetable for project development is shown in Figure 8. Powertech anticipates that the Dewey-Burdock uranium ore deposits will be commercially producible for <del>nine</del> eight years.  Powertech requests revising the text for consistency with the 8 years of production shown in Figure 8.
E16 - New Comment	20	Ensuring Protection of Adjacent USDWs			C	After groundwater restoration is completed for a wellfield, Powertech must conduct stability monitoring to determine that restored concentrations of ISR contaminants are chemically stable and will not rebound or increase in concentration over time. The NRC license requires that stability monitoring be conducted until the data show that the ISR contaminant concentrations for the most recent four consecutive quarters indicate no statistically significant increasing trend. If a constituent does not meet the stability criteria, Powertech must take appropriate actions to remedy the situation. Potential actions may include extending the stability monitoring period or returning the wellfield to a previous phase of active restoration until Powertech can demonstrate the chemical instability issue is resolved. If the analytical results from the stability period continue to meet the NRC license Commission Approved Background, MCLs, or ACLs and meet the stability criteria, Powertech will submit supporting documentation to the NRC showing that the restoration parameters have remained at or below the restoration standards and request that the wellfield be declared restored.

1 

2 

3 

**Comment type key:** A – alternate approach proposed; C – correct to be consistent with application, regulations or NRC license requirements; E – additional explanation requested; I – inconsistency (internally inconsistent between parts of Draft permit or supporting documents); R – remove; inconsistent with application, regulations or NRC license requirements; T – typographical error



---

 Number: 1 Author: vrobin03 Subject: Sticky Note Date: 10/18/2020 4:10:41 PM -06'00'

---

Comment #E14

The options included in the second draft ROD have been removed because EPA did not approve the exemption for Burdock Wellfield 6 and 7. In response to this comment the Part II, Section I.3 of the final Class III Area Permit contains a requirement to submit this information with the AE request for Burdock Wellfields 6 and 7.

---

 Number: 2 Author: vrobin03 Subject: Sticky Note Date: 10/18/2020 7:50:43 PM -06'00'

---

Comment #E15

This change was made in the final ROD.

---

 Number: 3 Author: vrobin03 Subject: Sticky Note Date: 11/4/2020 3:39:51 PM

---

Comment #E16

EPA agrees with this comment that adding reference to MCLs or ACLs is a more accurate description of the NRC License requirement for groundwater restoration standards and made this change in the final ROD.

**Table 3. Draft Aquifer Exemption Record of Decision Specific Comments (cont.)**

No.	Draft AE ROD		Fact Sheet		Type	Comment and Requested Modification
	Page	Section	Page	Section		
						Powertech requests adding "MCLs, or ACLs," since these are alternate standards for groundwater restoration.
E17-New Comment	22-25 of previous draft				C	It appears that all of the information that was on pp. 22-25 of the first draft ROD has been inadvertently omitted from the second draft, including the last two paragraphs under Vertical Confinement and entire sections on Lateral Confinement, Monitoring Requirements, A perimeter monitoring well ring, Operational groundwater monitoring, Monitoring within the wellfield during groundwater restoration, A groundwater stability monitoring period after restoration, Post-restoration groundwater monitoring, and Other Considerations. Powertech requests including this information in the final ROD based on what remains applicable.



---

 Number: 1 Author: vrobin03 Subject: Sticky Note Date: 10/18/2020 7:53:22 PM -06'00'

Comment #E17

These paragraphs were added back into the final ROD.



**Table 1. Draft Class V Area Permit Specific Comments and Recommended Permit Language Revisions**

No.	Draft Permit		Fact Sheet		Type	Comment and Recommended Permit Language Revision or Other Modification
	Page	Section	Page	Section		
3	4 14	II.A.1 II.I	34	5.3.4.1	R	<p><b>Comment:</b> Part II of the Revised Draft Class V Permit presents a regulatory process to obtain a Limited Authorization to Inject (LAI).</p> <p><b>Requested Change:</b> Powertech is not aware that a LAI is an established regulatory process, or is warranted in any way, for the proposed operation. Powertech is not aware that EPA Region 8 has included a LAI requirement for any Class V, Class I, or Class III permit and requests clarification as to why this permit requirement is necessary to protect USDWs, or, absent such clarification, Powertech requests removal of the LAI requirement. The testing procedures that are included under the LAI are routinely done in many similar well permits without a separate authorization, lack any significant potential for contamination of USDWs and are done with well casing in place. Powertech requests moving the Part II, Section A.1 requirements in entirety to Section A.2 (Information to Submit to the Director to Obtain an Authorization to Commence Injection). Further, from an operational standpoint, with the LAI process approval turnaround, drilling operations and equipment will be on standby until the EPA grants the LAI, which will cost Powertech significant resources for no additional protections.</p> <p>The LAI is mentioned in multiple places throughout the Revised Draft Class V Permit and in the Revised Draft Class V Fact Sheet, as Powertech commented in its Original EPA Letter and these comments still apply; however, for brevity, they are not repeated below.</p> <p><i>Response: For consistency with requirements for other injection well permits, the Class V Area Permit has been revised to remove the “Limited Authorization to Inject” (LATI) process. Instead of using a LATI to allow for testing, EPA will incorporate those testing requirements into the “Authorization to Inject” process. Limited injection is permissible prior to receiving authorization to inject only for the purposes of conducting the initial well logs and tests required under Part II. The Director will evaluate the information provided in the Injection Authorization Data Package Reports and may issue a written Authorization to inject for each injection zone only after finding that the conditions described in Part II, Section J have been met.</i></p>

Comment type key: **A** – alternate approach proposed; **C** – correct to be consistent with application, regulations or NRC license requirements; **E** – additional explanation requested; **I** – inconsistency (internally inconsistent between parts of Draft permit or supporting documents); **R** – remove; inconsistent with application, regulations or NRC license requirements; **T** – typographical error



5	6	II.C Table 4			<p><b>Comment:</b> The Revised Draft Class V Permit states a “Fracture Finder” log will be run. Fracture Finder has different connotations to different people. To clarify, a micro-resistivity log would be an acceptable fracture finder log. A micro-resistivity log uses the same general principals as a normal resistivity (wireline) log, except it is a pad tool with small spacing that allows for very detailed evaluation of the wellbore face and the first 1-3 inches of the formation. It is useful to differentiate between wall cake from drilling mud, filtrate from drilling mud that has invaded the formation, and the formation fluid. It is also useful to identify zones that have significant fluid invasion (such as natural fracture intervals). For this reason, a micro-resistivity log is often referred to as a Fracture Finder log.</p> <p><b>Requested Change:</b> Add “(Micro-Resistivity)” after “Fracture Finder” in Table 4.</p> <p><i>Response: The EPA made the requested change to the Class V Area Permit. The term “micro-resistivity” was added in parentheses following “Fracture Finder” in Table 4 for clarification.</i></p>
---	---	-----------------	--	--	--

Comment type key: **A** – alternate approach proposed; **C** – correct to be consistent with application, regulations or NRC license requirements; **E** – additional explanation requested; **I** – inconsistency (internally inconsistent between parts of Draft permit or supporting documents); **R** – remove; inconsistent with application, regulations or NRC license requirements; **T** – typographical error



**Table 1. Draft Class V Area Permit Specific Comments and Recommended Permit Language Revisions (Cont.)**

No.	Draft Permit		Fact Sheet		Type	Comment and Recommended Permit Language Revision or Other Modification
	Page	Section	Page	Section		
9	7-9	II.D Tables 6 and 7  II.D.2.b- h	33	Table 12	R, A, E	<p><b>Comments:</b> Total Dissolved Solids (TDS) results for samples collected from cased and perforated intervals will inform EPA’s authorization to inject and open-hole logs will be used by Powertech to assess formation characteristics and establish perforation intervals. Collecting open-hole samples is therefore not a vital component of well construction and therefore should not be required by the permit. Furthermore, where uncased hole stability presents a risk of hole collapse, collecting open-hole samples may not be achievable.</p> <p>Powertech intends to collect a single cased-hole sample from each injection well unless a confining layer is present between perforated zones where upon samples will be collected from each injection interval isolated by a confining layer.</p> <p><b>Requested Changes:</b> Powertech requests requirements for open-hole aquifer fluid sampling be removed from the permit. In the event open-hole sampling requirements cannot be removed from the permit, Powertech requests the wording be changed to indicate open-hole samples “can be collected at Powertech’s discretion” or “will be collected if practical,” or similar, to provide for the possibility that open-hole sampling may not be achievable.</p> <p>EPA clarifies that open-hole sampling was included to allow the Permittee the option to characterize the water quality from each aquifer specified in Table 6 of the Class V Area Permit prior to perforating and swab sampling. Collection of open-hole samples is not a vital component of the formation testing program. The Class V Area Permit has been revised to indicate the Permittee has discretion to collect open-hole samples to provide flexibility for preliminary characterization of injection zones prior to perforating and swab sampling. Permit requirements for cased-hole sampling remain unchanged.</p> <p>Powertech requests “each discreet Minnelusa perforated interval” in Table 6 of the draft permit and “each Minnelusa injection interval” in Table 12 of the draft fact sheet be defined to mean each perforated zone in the Minnelusa Formation separated by a confining layer. The intent of this definition is to allow a single sample to be collected from across perforated intervals in each injection well in the absence of a confining layer between perforated intervals.</p> <p><b>Response:</b> To improve clarity and allow a single sample to be collected from across perforated</p>

**Comment type key:** **A** – alternate approach proposed; **C** – correct to be consistent with application, regulations or NRC license requirements; **E** – additional explanation requested; **I** – inconsistency (internally inconsistent between parts of Draft permit or supporting documents); **R** – remove; inconsistent with application, regulations or NRC license requirements; **T** – typographical error



						intervals in the absence of a confining layer between perforated intervals, the Permit also has been revised to specify that formation testing described in Tables 6 and 7 relates to each perforated zone in the Minnelusa Formation separated by a confining layer. The word “interval” on pages 4, 8, and 10, Part II, Sections A.1, D.2, and D.3 also has been replaced with “zone” for consistency with Tables 6 and 7.
10	8	II.D.2.a	32	5.3.1	R, A	<p><b>Comment:</b> A fluorescent dye tracer is being required to differentiate between drilling mud and formation fluid. Powertech is concerned that maintaining sufficient dye in the system for detection may not be possible.</p> <p><b>Requested Change:</b> Powertech requests the following be added at the end of II.D.2.a. to address the case where sufficient dye for detection cannot be maintained in the system: “In the event that the dye dissipates in the drilling mud or formation fluid to the extent that it is not detectable during sampling, it is understood that stabilized field parameters will be relied upon to establish the presence of native formation fluid in a given sample.”</p> <p><b>Response:</b> To allow for the possibility that sufficient dye for detection may not be maintained in the drilling mud, Part II, Section D.2.a has been revised to state ‘In the event that the dye dissipates in the drilling mud or formation fluid to the extent that it is not detectable during sampling, stabilized values of pH and conductivity during three successive casing volumes may be used to establish the presence of native formation fluids in accordance with Part II, Section D.2.d.v.’.</p>

Comment type key: **A** – alternate approach proposed; **C** – correct to be consistent with application, regulations or NRC license requirements; **E** – additional explanation requested; **I** – inconsistency (internally inconsistent between parts of Draft permit or supporting documents); **R** – remove; inconsistent with application, regulations or NRC license requirements; **T** – typographical error



**Table 1. Draft Class V Area Permit Specific Comments and Recommended Permit Language Revisions (Cont.)**

No.	Draft Permit		Fact Sheet		Type	Comment and Recommended Permit Language Revision or Other Modification
	Page	Section	Page	Section		
12	7 12	II.D Table 7 II.E.3.b.i II.F.2.a	30	4.4.4	C	<p><b>Comment:</b></p> <p>Powertech repeats its concern that since the Revised Draft Class V Permit duration is 10 years, it would be appropriate to model the drawdown in the Madison aquifer for 10 years rather than 12 years as currently required. A shorter duration for drawdown modeling is also warranted because the drawdown in the Madison is expected to be minimal with little change over time (Exhibit 001 at 9-10). Similarly, it would be more appropriate to calculate the injection zone formation pressures resulting from 10 years of injection activity rather than 12 years.</p> <p><b>Response:</b> The EPA agrees that modeling drawdown in the Madison aquifer and calculating injection zone formation pressures over a period of 10 years is appropriate for the Class V Area Permit, which is issued for a period of 10 years. For consistency with the Permit duration, the Permit was revised to indicate modeling and calculations will be based on a period of 10 years rather than 12 years. Part II, Section F of the Permit also was revised to indicate that if the Permit is renewed or modified for a period longer than 10 years, calculations of critical pressure rise, injection-induced pressure, and maximum injection rate shall be re-evaluated for the revised period of injection, including the effects of drawdown in the Madison aquifer and additional Minnelusa injection wells.</p>
14	9 9	II.D Table 8  II.D.2.g	34	Table 13	I, C	<p><b>Comments:</b></p> <ol style="list-style-type: none"> <li>Are analyses for metals and radionuclides total or dissolved fractions?</li> <li>Why are the analytical methods different from those listed in the Revised Draft Class III Permit (e.g., alkalinity, bicarbonate, sulfate, etc. have different methods in Table 8 of the</li> </ol>

Comment type key: **A** – alternate approach proposed; **C** – correct to be consistent with application, regulations or NRC license requirements; **E** – additional explanation requested; **I** – inconsistency (internally inconsistent between parts of Draft permit or supporting documents); **R** – remove; inconsistent with application, regulations or NRC license requirements; **T** – typographical error





POWERTECH (USA) INC.

	30	V.D.2.a.i Table 16		<p>Revised Draft Class III Permit)?</p> <p>c. What would be the process for obtaining approval of alternate analytical methods for cased-hole samples?</p> <p><b>Requested Changes:</b></p> <p>a. In Tables 8 and 16, metals and radionuclide samples should be analyzed for dissolved fractions to provide analytical results that represent the soluble (mobile) metals rather than suspended (particulate) metals. Dissolved analyses generally are preferred for most RCRA, CERCLA, and SDWA programs and are consistent with permit requirements for UIC wells in other EPA regions and states. This would also be consistent with NRC requirements under the approved license, SUA-1600, for the Dewey-Burdock Project.</p> <p><i>Response: For clarity, Part II, Section D.2 and Part V, Section D.1 have been revised to indicate that, except as may be required by the analytical method(s) shown in Table 8 or former Table 16 (updated to be Table 14), samples shall be analyzed for dissolved fractions. A footnote also was added to former Table 16 to indicate that permit limits for metals and radionuclides are for dissolved fractions.</i></p> <p>b. In Table 8, Powertech requests that analytical methods be changed to be consistent with the Final Class III Permit, Table 8, which should reflect Powertech’s comments for the Revised Draft Class III Permit on Table 8. This would also make the laboratory analytical methods consistent with NRC license requirements (specifically with Table 6.1-1 of the approved NRC license application). This will bring a consistency for data collected across the project. Further, Powertech requests that total analysis may be left as an alternative method if needed.</p> <p><i>Response: Where applicable, analytical methods presented in Table 8 were revised to be consistent with methods presented in Table 8 of the Class III Area Permit and Table 6.1-1 of the approved NRC license application.</i></p> <p>c. Powertech requests II.D.2.g. second asterisk on page 9 regarding cased-hole samples be modified by adding the sentence, “Equivalent analytical methods may be used after prior approval by the Director” at the end to address the process for obtaining approval for alternate analytical methods for cased-hole samples.</p> <p><i>Response: To allow for flexibility of analytical methods if needed, Part II, Section D.2 and Part V, Section D.1 have been revised to state that equivalent analytical methods or total recoverable analysis may be used after prior approval by the Director.</i></p>
--	----	-----------------------	--	--

Comment type key: **A** – alternate approach proposed; **C** – correct to be consistent with application, regulations or NRC license requirements; **E** – additional explanation requested; **I** – inconsistency (internally inconsistent between parts of Draft permit or supporting documents); **R** – remove; inconsistent with application, regulations or NRC license requirements; **T** – typographical error



**Table 1. Draft Class V Area Permit Specific Comments and Recommended Permit Language Revisions (Cont.)**

No.	Draft Permit		Fact Sheet		Type	Comment and Recommended Permit Language Revision or Other Modification
	Page	Section	Page	Section		
16	12	II.F.2.c	26, 30	4.4.2.1 Table 9	I, R	<p><b>Comment:</b> Powertech repeats its concern that there is no evidence whatsoever that (a) oil/gas wells or (b) the Dewey Fault are potential conduits for flow from the Minnelusa injection zone to the first overlying aquifer. This characterization is supported by the permit application and the South Dakota DENR Report to the Chief Engineer on Water Permit Application No. 2685-2 (Exhibit 001 at 9, paragraph 1). See Comment #16 in the Original EPA Letter.</p> <p><b>Response:</b> The EPA acknowledges that available records for abandoned oil and gas test wells penetrating the Minnelusa Formation in the vicinity of the proposed Class V injection wells list cementing intervals that suggest the wells have been plugged to prevent flow out of the Minnelusa Formation into overlying or underlying USDWs. However, because cement-bond logs or other information could not be found to confirm the location and quality of the cement placement within the wellbore, EPA did not revise Part II, Section F.2.c of the Class V Area Permit to remove the requirement that the Permittee demonstrate that each injection well is located a sufficient distance away from abandoned oil and gas test wells to prevent the potential for movement of fluids into USDWs.</p> <p>Furthermore, EPA has determined that the hydrologic properties of the Dewey Fault are not sufficiently well characterized to determine the potential for vertical flow through the fault at the depth of the Minnelusa Formation. Although results of aquifer testing provide some indication that the Dewey Fault acts as a barrier to horizontal flow in the Chilson aquifer (Boggs, 1983 at 12), geochemical data presented by Gott et al. (1974) and the presence of springs emanating from the Fall River aquifer along the Dewey Fault northwest of the project area may indicate that some vertical flow is occurring through the fault. These springs are described on page 4-5 and shown on Figure 4.6 of the Class III Permit application. Although the South Dakota DENR Report to the Chief Engineer on Water Permit Application No. 2685-2 states that “The displacement of the Madison Limestone caused by the Dewey Fault likely provides a north-south groundwater barrier for most of the length of the fault and drawdown from wells south of the fault is not expected to extend to the north of the fault.”, no support for this statement appears to be provided. EPA further notes that differences in the potentiometric surface between the Minnelusa and Madison 2 miles away from the fault may not reflect potentiometric conditions at the fault or preclude the possibility of limited flow occurring along it. Because the hydrologic properties of the Dewey Fault are uncertain at the depth of the Minnelusa Formation, the Final Class V Permit will maintain the requirement for the Permittee to demonstrate that each injection well is located a sufficient distance away from the Dewey Fault to prevent the potential for movement of fluids into USDWs.</p>

Comment type key: **A** – alternate approach proposed; **C** – correct to be consistent with application, regulations or NRC license requirements; **E** – additional explanation requested; **I** – inconsistency (internally inconsistent between parts of Draft permit or supporting documents); **R** – remove; inconsistent with application, regulations or NRC license requirements; **T** – typographical error



17	13	II.F.3.a	28	Sec. 4.4.2.2	R, C	<p><b>Comment:</b> There is no explanation or evidence for the 1,000-foot offset restriction around the pre-existing offset area surrounding plugged oil and gas wells. Powertech has already (conservatively) requested an offset from those wells, even though plugging records clearly indicate that wells are property plugged. There is no basis for EPA to add another 1,000 feet to the offset requested in the permit application. Because of records to the contrary, the Earl Darrow #1 well does not serve as a potential conduit for flow, and there are no other oil and gas test wells penetrating the Minnelusa or deeper in the project area. See Comment #17 in the Original EPA Letter.</p> <p>Response: The EPA clarifies that the 1,000-foot offset required by the Class V Area Permit is not in addition to the offset requested in the application for abandoned oil and gas wells. The required offset is simply 1,000 feet from the wellbore. As indicated in Table 18 of the Class V Area Permit Fact Sheet, the nearest potential breaches identified near the proposed DW No. 1 injection well are the Earl Darrow #1 oil and gas test well for the Minnelusa upper confining zone and the Sun #1 Lance Nelson oil and gas test well for the Minnelusa lower confining zone. The EPA acknowledges that records for the Earl Darrow #1 and Sun #1 Lance-Nelson list cementing intervals that suggest these wells have been plugged to prevent flow out of the Minnelusa Formation into overlying or underlying USDWs. However, because cement-bond logs or other information could not found to confirm the location and quality of cement placement within the wellbore, EPA did not remove the requirement to determine the maximum injection rate such that the critical pressure in each injection zone is not exceeded 1,000 feet away from the nearest abandoned oil and gas well having a potential breach in the Minnelusa confining zones. Because the hydrologic properties of the Dewey Fault are uncertain (see response to Comment 16 above) and its location is not precisely known at the depth of the Minnelusa Formation, the Final Class V Area Permit also will maintain the requirement for the Permittee to determine the maximum injection rate such that the critical pressure in each injection zone is not exceeded 1,000 feet away from the Dewey Fault.</p>
18/21	Various	Various	---	---	I	<p><b>Requested Change:</b> For consistency with regulatory requirements and for internal consistency, Powertech requests references to EPA or EPA Region 8 be changed to “the Director” wherever reference is being made to EPA in its role as UIC program Director. Some, but not all instances of this were updated in the Revised Draft Class V Permit.</p> <p>Response: For internal consistency, the 2<sup>nd</sup> Draft Class V Area Permit was revised to replace references to EPA in its role as UIC Program Director with “Director” at the following places: Part II, Section J.4.c, Part III, Section K.1, Part V, Section C.6.b.iii, and Part VI, Section A.</p>

Comment type key: **A** – alternate approach proposed; **C** – correct to be consistent with application, regulations or NRC license requirements; **E** – additional explanation requested; **I** – inconsistency (internally inconsistent between parts of Draft permit or supporting documents); **R** – remove; inconsistent with application, regulations or NRC license requirements; **T** – typographical error



						References were not changed where the more general original term is appropriate because the term "Director" is not necessarily applicable, such as for witnessing or evaluating tests or for receiving or transmitting documents.
22	15	II.J Table 10	35	Table 14	I, C	<p><b>Comment:</b> The permit requirement limits Part II MIT logging to Radioactive Tracer (RAT) logs. Few vendors run RAT logs, and it may be difficult for those vendors to get a license to bring RAT tools into South Dakota. Temperature logs should also be considered.</p> <p><b>Requested Change:</b> EPA Guidance No. 37 indicates that Part II MIT may be demonstrated by cement bond log showing 80% bond through an appropriate interval, or radioactive tracer survey, or temperature survey. Further, 40 CFR § 146.8 (general UIC) clearly indicates that a temperature log alone may be used. It states that other or alternate tests may be allowed by the Director/Administrator or may be required if the results are unsatisfactory. Powertech is committed to running a cement bond log and a temperature log to demonstrate Part II MIT. This process is commonly used on Class I wells in EPA Region 8 pursuant to 40 CFR § 146.14(b). Powertech requests the following change to provide flexibility in the event that RAT tools cannot be located.</p> <p><b>Response:</b> The EPA agrees that a temperature survey or a radioactive tracer survey can be used effectively to demonstrate external (Part II) mechanical integrity in conjunction with a cement bond log. Part II, Sections A.2, J.5, and K.1; Part IV, Section C.2.c; and Table 10 of the 2nd Draft Class V Area Permit were revised to indicate that a temperature survey or a radioactive tracer survey may be used to assess baseline external Mechanical Integrity. Part V, Section C.6.c also has been revised to indicate that either a temperature survey or a radioactive tracer survey (rather than both concurrently) may be used for ongoing demonstration of external mechanical integrity. Table 13 (Ongoing External Mechanical Integrity Testing Methods) was removed because it is no longer needed.</p>

Comment type key: **A** – alternate approach proposed; **C** – correct to be consistent with application, regulations or NRC license requirements; **E** – additional explanation requested; **I** – inconsistency (internally inconsistent between parts of Draft permit or supporting documents); **R** – remove; inconsistent with application, regulations or NRC license requirements; **T** – typographical error



**Table 1. Draft Class V Area Permit Specific Comments and Recommended Permit Language Revisions (Cont.)**

No.	Draft Permit		Fact Sheet		Type	Comment and Recommended Permit Language Revision or Other Modification						
	Page	Section	Page	Section								
						<p><b>Table 10. Formation Testing Involving Injection</b></p> <table border="1"> <thead> <tr> <th>TYPE OF TEST</th> <th>PURPOSE</th> </tr> </thead> <tbody> <tr> <td>Step Rate Test</td> <td>Initial test to determine site specific fracture gradient pressure to use calculating MAIP permit for each well. Injection pressures shall be monitored at surface and bottom hole to determine friction loss for each well.</td> </tr> <tr> <td>Initial Radioactive Tracer Survey <b>or</b> <b>Temperature Log</b></td> <td>Baseline assessment of ability of the cement behind the longstring casing to prevent movement of injected fluids out of the approved injection formation.</td> </tr> </tbody> </table>	TYPE OF TEST	PURPOSE	Step Rate Test	Initial test to determine site specific fracture gradient pressure to use calculating MAIP permit for each well. Injection pressures shall be monitored at surface and bottom hole to determine friction loss for each well.	Initial Radioactive Tracer Survey <b>or</b> <b>Temperature Log</b>	Baseline assessment of ability of the cement behind the longstring casing to prevent movement of injected fluids out of the approved injection formation.
TYPE OF TEST	PURPOSE											
Step Rate Test	Initial test to determine site specific fracture gradient pressure to use calculating MAIP permit for each well. Injection pressures shall be monitored at surface and bottom hole to determine friction loss for each well.											
Initial Radioactive Tracer Survey <b>or</b> <b>Temperature Log</b>	Baseline assessment of ability of the cement behind the longstring casing to prevent movement of injected fluids out of the approved injection formation.											
25	20	III.D	---	---	I,C	<p><b>Comment:</b> Powertech requests removing Sections III.D.4.c and III.D.5, since field conditions will dictate cement volumes and casing centralizer spacing. It is inappropriate for the EPA to specify these construction requirements, since Powertech will demonstrate Part II MIT in accordance with the permit and UIC regulations.</p> <p><b>Requested Change:</b> 4. The Permittee shall use cement: a. Of sufficient quantity and quality to withstand the maximum operating pressure; and b. Which is resistant to deterioration from formation and injection fluids; <del>and</del> <del>c. In a quantity no less than 120% of the calculated volume necessary to cement off a zone.</del> <del>5. A float shoe shall be used with a float collar one or two joints up from the bottom of the casing and centralizers shall be placed at a minimum of one on every fifth casing joint.</del></p> <p><b>Response:</b> EPA does not agree that it is not inappropriate for EPA to specify construction requirements for Class V wells. Consistent with the UIC regulations, EPA must ensure that well construction meets the requirements of 40 CFR §§ 144.52(a)(1) and is adequately protective of USDWs. The requirement to use cement in a quantity no less than 120% of the calculated volume to cement off a zone is specified by regulation at 40 CFR § 147.2104. Therefore, EPA did not change this requirement. UIC regulations do not specify use of a float shoe, so EPA has reworded this requirement to provide flexibility to the Permittee to use a float shoe and collar as field conditions dictate. Under 40 CFR part 147, subpart QQ, UIC regulations specific to the state of South Dakota, § 147. 2104(c) states the owner or operator of a newly drilled well shall install centralizers as directed by the Regional Administrator. EPA has determined that placing</p>						

**Comment type key:** **A** – alternate approach proposed; **C** – correct to be consistent with application, regulations or NRC license requirements; **E** – additional explanation requested; **I** – inconsistency (internally inconsistent between parts of Draft permit or supporting documents); **R** – remove; inconsistent with application, regulations or NRC license requirements; **T** – typographical error



POWERTECH (USA) INC.

						centralizers at a minimum of every fifth casing joint is a reasonable requirement, so the requirement for centralizers was not removed. To improve clarity, the centralizer requirement was made as a separate provision.
28	22 24	III.L.2 IV.F.3	43	7.3	I, C	<b>Comment:</b> The draft permit states certain minor modifications, such as adding perforations within the already approved injection zone, would be major modifications. This appears to be inconsistent with 40 CFR 144.39, which states, "If a permit modification satisfies the criteria in § 144.41 for "minor modifications" the permit may be modified without a draft permit or public review." § 144.41 allows the Director to change construction requirements pursuant to § 144.52(a)(1) provided that any such alteration complies with the requirements of part 144 and part 146. § 144.52(a)(1) stipulates that "changes in construction plans during construction" may be approved as minor modifications provided that no such changes may be physically incorporated into construction of the well prior to approval of the modification by

Comment type key: **A** – alternate approach proposed; **C** – correct to be consistent with application, regulations or NRC license requirements; **E** – additional explanation requested; **I** – inconsistency (internally inconsistent between parts of Draft permit or supporting documents); **R** – remove; inconsistent with application, regulations or NRC license requirements; **T** – typographical error



**Table 1. Draft Class V Area Permit Specific Comments and Recommended Permit Language Revisions (Cont.)**

No.	Draft Permit		Fact Sheet		Type	Comment and Recommended Permit Language Revision or Other Modification
	Page	Section	Page	Section		
						<p>the Director. Powertech interprets this to mean that perforating in the approved injection zone constitutes a “change in construction plans during construction” because adding perforations in the already approved injection zone is a continuance of well construction within the approved well construction plans. Powertech therefore proposes that the addition of perforations in the approved injection zone should either not require additional approval or should be approved as a minor modification rather than requiring a major modification of the permit. It is common for many UIC well classes that perforations are added within the approved injection zone due to physical plugging, friction loss, or additional porosity discovered through data analysis. In all of these examples, additional perforations would help inject more fluid at a lower injection pressure but would not affect fluid containment described in the permit application or specified in the Permit. Also, there is no requirement in 40 CFR 144 or 146 to conduct MIT after adding additional perforations assuming the packer and tubing are not removed. If tubing and packer were removed to add perforations, Part I MIT would be necessary once the tubing and packer were replaced.</p> <p><b>Requested Change:</b> Powertech repeats its request for the following changes.</p> <p><b>III.L. Workovers and Alterations</b> 4. Any modification to well construction that is <b>substantially</b> different from the approved well construction plan is allowed only as a major modification of this Area Permit according to 40 CFR § 144.39 and § 124.5.</p> <p><b>IV.F. Approved Injection Zone and Perforations</b> 3. Additional injection perforations may be added once the following requirements are met: a. The new perforations remain within the approved injection zone, b. The top perforation is no higher than the approved top of the injection zone <del>c. The Permittee has received approval from the Director as a major modification of this Permit in accordance with Part III, Section C.2 of this Permit; and</del> <del>d. The Director approves the addition of perforations as a major modification of this Area Permit according to 40 CFR § 144.39 and § 124.5.</del> <del>c.e.</del> After the addition of perforations, the Permittee shall follow the requirements for well Workovers and Alterations under Part III, Section L <b>if the tubing and packer are removed to add the perforations.</b></p>

Comment type key: **A** – alternate approach proposed; **C** – correct to be consistent with application, regulations or NRC license requirements; **E** – additional explanation requested; **I** – inconsistency (internally inconsistent between parts of Draft permit or supporting documents); **R** – remove; inconsistent with application, regulations or NRC license requirements; **T** – typographical error



POWERTECH (USA) INC.

						<p>Response: Whether a permit modification may be processed as minor, instead of major, is determined by the regulations at 40 CFR §§ 144.39 and 144.41. Therefore, where the Permits specify that a modification must be major or minor, the provisions were changed to clarify that a change to the condition would require a modification in accordance with 40 CFR §§ 144.39 and 144.41.</p> <p>EPA agrees that the addition of perforations to an approved injection zone after completing initial construction is consistent with the intended allowable construction specifications and can be included in the approved well construction. Therefore, a provision was added to Part III, Section E (Well Casing Perforations) to clarify that additional perforations may be added to an approved injection zone after initial construction is complete in accordance with Part IV, Section F.3. To be clear, because EPA is including perforations to an approved injection zone as part of the approved well construction standards, there is no need to modify the permit when appropriate perforations are made.</p> <p>Part IV, Section F.3 (Approved Injection Zone and Perforations) was revised to remove references to major modifications with respect to such perforations and to add the following requirements: 1) The Permittee must provide notice to the Director in accordance with Part III, Section L for well Workovers and Alterations. The Permittee shall also follow the requirements for the Injection Pressure Limit found in Part IV Section H, which may result in a change to the permitted MAIP, and 2) Fracture gradient data submitted is representative of the portion of the injection zone to be perforated. Because the requirements for Workovers and Alterations under Part III, Section L are applicable whether or not the tubing and packer are removed, the Permit has not been revised to allow for this exception.</p>
--	--	--	--	--	--	---

Comment type key: **A** – alternate approach proposed; **C** – correct to be consistent with application, regulations or NRC license requirements; **E** – additional explanation requested; **I** – inconsistency (internally inconsistent between parts of Draft permit or supporting documents); **R** – remove; inconsistent with application, regulations or NRC license requirements; **T** – typographical error





**Table 1. Draft Class V Area Permit Specific Comments and Recommended Permit Language Revisions (Cont.)**

No.	Draft Permit		Fact Sheet		Type	Comment and Recommended Permit Language Revision or Other Modification
	Page	Section	Page	Section		
29	25	IV.K.1	47	7.8	I, C	<p><b>Comment:</b> Powertech repeats its concern that there are several waste streams identified in the Waste Analysis Plan included with the permit application that are not included in the list of waste fluids in the draft permit (e.g., restoration bleed [whether or not it is processed through RO], yellowcake wash water, bleed from effluent and precipitation circuits, sumps, membrane cleaning solutions, groundwater sweep solutions, and plant washdown water).</p> <p><b>Requested Change:</b> Powertech requests adding the waste streams above, which were included in the permit application, to the permit text. All fall into the category of waste fluids generated by the ISR process, which is already described in the draft permit. Requested changes are provided below.</p> <p><b>IV.K. Approved Injectate</b> 1. Injection fluid is limited to waste fluids from the ISR process generated by the Dewey-Burdock Project. These waste fluids include groundwater produced from well construction, laboratory waste fluids, well field production bleed, <del>and</del> concentrated brine generated from the reverse osmosis treatment of groundwater produced from wellfield during groundwater restoration, <b>restoration bleed not processed by reverse osmosis, yellowcake wash water, bleed from effluent and precipitation circuits, sumps, membrane cleaning solutions, groundwater sweep solutions, and plant washdown water.</b> The groundwater pumped from any portion of the Inyan Kara aquifers for the purpose of remediating an excursion is also approved for injection into the Class V injection wells.</p> <p><i>Response: Part IV, Section K.1 was revised to clarify that waste fluids from only the Dewey Burdock Project are considered approved injectate. The identified additional waste streams fall into the category of waste fluids from the ISR process generated by the Dewey Burdock Project. Therefore, these additional waste streams were included with those considered to be approved injectate to reflect those identified in the Waste Analysis Plan included with the permit application.</i></p>
30	26  31-32	V.B., V.B.1 Tables 17A and 17F	53	8.1.2.2	I, C	<p><b>Requested Change:</b> See Comment #30 from the Original EPA Letter. Powertech requests that the 4.0 magnitude requirement in the fact sheet and in the second paragraph of V.B. and in V.B.1. of the Revised Draft Class V Permit be changed to a 4.5 magnitude. In addition, for consistency with V.B.4, Powertech requests a 2.0 magnitude be specified in Tables 17A and 17B as shown below.</p> <p><i>Response: Because earthquake magnitudes of 4.0 and 4.5 (MMI) both generally are</i></p>

**Comment type key:** **A** – alternate approach proposed; **C** – correct to be consistent with application, regulations or NRC license requirements; **E** – additional explanation requested; **I** – inconsistency (internally inconsistent between parts of Draft permit or supporting documents); **R** – remove; inconsistent with application, regulations or NRC license requirements; **T** – typographical error



						<p>considered to be classified as “minor to light” (<a href="https://www.usgs.gov/media/images/eq-magnitude-energy-release-and-shaking-intensity-5">https://www.usgs.gov/media/images/eq-magnitude-energy-release-and-shaking-intensity-5</a>) and EPA has determined that the Dewey-Burdock site is in an area of historically low seismic potential as discussed in Section 4.10 of the Class III Area Permit Fact Sheet, Part V, Section B of the Class V Area Permit has been revised to indicate that if any seismic event of magnitude 4.5 (MMI scale) or greater is reported within two miles of the permit boundary, the Permittee shall immediately cease injection and notify the Director within twenty-four (24) hours. Tables 17A and 17F also were revised to clarify that monitoring and reporting is required for seismic events greater than or equal to 2.0 (MMI Scale) within a fifty (50) mile radius of the Area Permit boundary.</p> <p><b>Table 17. Monitoring, Recording and Reporting Requirements for Well Operating Parameters</b></p> <table border="1"> <tr> <td colspan="2">A. CONTINUOUS MONITORING</td> </tr> <tr> <td>MONITOR</td> <td>Seismic events <b>with greater than 2.0 magnitude (MMI scale)</b> within a two (2) mile radius of the Area Permit boundary, gathered from USGS Earthquake Hazard Program website or through personal communication.</td> </tr> </table>	A. CONTINUOUS MONITORING		MONITOR	Seismic events <b>with greater than 2.0 magnitude (MMI scale)</b> within a two (2) mile radius of the Area Permit boundary, gathered from USGS Earthquake Hazard Program website or through personal communication.
A. CONTINUOUS MONITORING										
MONITOR	Seismic events <b>with greater than 2.0 magnitude (MMI scale)</b> within a two (2) mile radius of the Area Permit boundary, gathered from USGS Earthquake Hazard Program website or through personal communication.									

Comment type key: **A** – alternate approach proposed; **C** – correct to be consistent with application, regulations or NRC license requirements; **E** – additional explanation requested; **I** – inconsistency (internally inconsistent between parts of Draft permit or supporting documents); **R** – remove; inconsistent with application, regulations or NRC license requirements; **T** – typographical error



**Table 1. Draft Class V Area Permit Specific Comments and Recommended Permit Language Revisions (Cont.)**

No.	Draft Permit		Fact Sheet		Type	Comment and Recommended Permit Language Revision or Other Modification				
	Page	Section	Page	Section						
						<p><b>Table 17. Monitoring, Recording and Reporting Requirements for Well Operating Parameters</b></p> <table border="1"> <tr> <td colspan="2">F. QUARTERLY MONITORING</td> </tr> <tr> <td>REPORT</td> <td>Summary of monthly reviews of seismic events <b>with greater than 2.0 magnitude (MMI scale)</b> within a fifty (50) mile radius of the Area Permit boundary.</td> </tr> </table>	F. QUARTERLY MONITORING		REPORT	Summary of monthly reviews of seismic events <b>with greater than 2.0 magnitude (MMI scale)</b> within a fifty (50) mile radius of the Area Permit boundary.
F. QUARTERLY MONITORING										
REPORT	Summary of monthly reviews of seismic events <b>with greater than 2.0 magnitude (MMI scale)</b> within a fifty (50) mile radius of the Area Permit boundary.									
33	28-29	V.D.1.d., V.D.1.h., V.D.1.i Table 14	---	---	I, R, C	<p><b>Comments:</b> Powertech notes Table 14 is no longer needed or referenced in the permit because stabilization requirements are stated in II.D.2.g. In addition, Powertech restates its request for modifying Part V, Sections D.1.d, h and i for flexibility as shown below.</p> <p><b>Requested Changes:</b> Powertech requests Table 14 be removed from the permit because it is no longer needed and that the following revisions be made to Part V, Section D.1.d., D.1.h. and D.1.i.</p> <p><b>V.D. Monitoring Methods, Parameters and Frequency</b></p> <p><b>1. Monitoring Methods</b></p> <p>d. Injection pressure, annulus pressure, injection rate, and cumulative injected volumes shall be observed and recorded under normal operating conditions, and all parameters shall be observed <b>simultaneously at the same general time</b> to provide a clear depiction of well operation.</p> <p>h. Fluid volumes are to be measured in standard oilfield barrels (bbl) <b>or gallons (gal)</b>.</p> <p>i. Fluid rates are to be measured in barrels per day (bbl/day) <b>or gallons per minute (gpm)</b>.</p> <p><i>Response: EPA agrees that Table 14 is no longer needed or referenced in the Class V Area Permit. The table has been removed. Stabilization criteria from Table 14 for pH and specific conductance have been added to the text of Part II, Section D.2. Part V, Section D.1.d. has not been revised to indicate that parameters shall be observed "at the same general time". Simultaneous observation of parameters is a standard permit requirement. To provide flexibility for measuring fluid volumes and rates, Section D.1.h. has been revised to indicate that fluid volumes are to be measured in standard oilfield barrels (bbl) or gallons (gal), and Section D.1.i. has been revised to indicate that fluid rates are to be measured in barrels per day (bbl/day) or gallons per minute (gpm).</i></p>				

Comment type key: **A** – alternate approach proposed; **C** – correct to be consistent with application, regulations or NRC license requirements; **E** – additional explanation requested; **I** – inconsistency (internally inconsistent between parts of Draft permit or supporting documents); **R** – remove; inconsistent with application, regulations or NRC license requirements; **T** – typographical error



POWERTECH (USA) INC.

34	33	V.E.2	56	8.2	I, E	<p><b>Comment:</b> Powertech repeats its uncertainty regarding why 40 CFR part 146 subpart G regulations are referenced as those regulations refer to Class I hazardous waste injection wells.</p> <p><b>Requested Change:</b> Please explain the basis for reference to 40 CFR part 146 subpart G, which pertains to Class I hazardous waste injection wells. This permit is not for a Class I hazardous waste injection well; permit conditions prohibit injection of hazardous waste.</p> <p><b>Response:</b> The EPA clarifies that the reference in Part V, Section E.2 of the Class V Area Permit to “plugging and abandonment (P&amp;A) procedures specified under 40 CFR § 144.52(a)(6) or under part 146 subpart G, as appropriate” is standard permit language from 40 CFR § 144.51(j)(2)(ii) for conditions applicable to all permits and does not imply the Dewey Burdock Class V Area Permit is for a Class I hazardous waste injection well. To improve clarity, the reference to part 146 subpart G has been removed from Part V, Section E.2 of the Final Class V Area Permit.</p>
35	34-35	V.G	42 55	6.5, 8.1.5	I, C	<p><b>Comment:</b> Powertech will operate a manned facility. Why are there automated monitoring and shut-off requirements that would apply whether the facility is manned or unmanned? In addition, the</p>

Comment type key: **A** – alternate approach proposed; **C** – correct to be consistent with application, regulations or NRC license requirements; **E** – additional explanation requested; **I** – inconsistency (internally inconsistent between parts of Draft permit or supporting documents); **R** – remove; inconsistent with application, regulations or NRC license requirements; **T** – typographical error



**Table 1. Draft Class V Area Permit Specific Comments and Recommended Permit Language Revisions (Cont.)**

No.	Draft Permit		Fact Sheet		Type	Comment and Recommended Permit Language Revision or Other Modification
	Page	Section	Page	Section		
						<p>monitoring requirements in Part V, Section G.6.h through k apply regardless of manned or remote operations.</p> <p><b>Requested Change:</b> Powertech requests the addition of a qualifier to indicate that automatic monitoring guidelines must be followed only if the facility is unmanned. In addition, Powertech suggests moving the requirements in Part V, Section G.6.h through k to Part V, Section D.4 (Page 33).</p> <p><b>Response:</b> EPA did not make the requested change to the Class V Area Permit to indicate that automatic monitoring guidelines must be followed only if the facility is unmanned. EPA has determined that whether the facility is manned or unmanned, the requirements for automated monitoring and shut-off devices described in Part V, Section G of the Class V Area Permit are necessary to notify the operator if Area Permit conditions related to minimum or maximum set points are met and to automatically halt injection operations. However, the EPA acknowledges that the monitoring requirements listed under Part V, Section G.6.h–k (and G.6.g) would apply regardless of manned or remote operations. Part V, Section G of the Class V Area Permit has been revised to clarify which requirements apply only to remote operations and which apply to both manned and unmanned operations.</p>
39	43-44	VIII.C	58	10.2, 10.3	I, A	<p><b>Comment:</b> Powertech notes there are no other ISR projects in Region 8 where financial responsibility has been required to be posted prior to issuance of the final permit; instead, in these other cases, demonstration of financial responsibility has been required after permit issuance but prior to construction. Powertech notes that these new requirements are not standard to other uranium ISR projects in Region 8 and are not required by regulation. Please refer to Comment #59 of this letter.</p> <p><b>Response:</b> Please see response to Comment #59 below.</p>
						<b>Fact Sheet Only</b>

Comment type key: **A** – alternate approach proposed; **C** – correct to be consistent with application, regulations or NRC license requirements; **E** – additional explanation requested; **I** – inconsistency (internally inconsistent between parts of Draft permit or supporting documents); **R** – remove; inconsistent with application, regulations or NRC license requirements; **T** – typographical error



POWERTECH (USA) INC.

52	---	---	4, 8	1.0, 2.1	I, R	<p><b>Comment:</b> Powertech restates its concern that waste generated on site will be 11e.(2) byproduct material regulated by NRC, not hazardous waste according to RCRA. The references stating that Powertech will treat fluid to below hazardous standards implies that hazardous fluid exists on site. Language in the draft permit already prohibits injection of hazardous waste into the Class V wells.</p> <p><b>Requested Change:</b> Powertech requests removal of the repeated references that characterize site waste as hazardous because this is not accurate; it is 11e.(2) byproduct material. This comment also applies to similar statements on page 1 and elsewhere in the Draft Cumulative Effects Analysis.</p> <p><i>Response: The 2019 Class V Fact Sheet contains information related to Version 2 of the Draft Class V Area Permit and will not be updated for the Final Class V Area Permit. EPA clarifies that, in accordance with Part V, Section K.2 of the Class V Area Permit, the injection of fluids with constituent concentrations above the hazardous waste or radioactive waste concentration limits is prohibited. The injectate must meet the permit limits set in Part V, Section D.2.a, Table 14 (formerly Table 16).</i></p>
53	---	---	23-29	4.4.1 4.4.2 4.4.2.1 4.4.2.2 4.4.3	R, C, A	<p><b>Comment:</b> Powertech repeats its comment that assignment of 10% porosity to the Minnelusa based on Greene (1993) data is incorrect and leads to a greatly exaggerated and inaccurate Radius of Fluid Displacement (ROFD) calculation. Please refer to comment #53 in the Original Draft Permit for data that show the average density porosity is 19% in the Minnelusa in the project area.</p> <p><i>Response: The 2019 Class V Fact Sheet contains information related to Version 2 of the Draft Class V Area Permit and will not be updated for the Final Class V Area Permit. EPA clarifies that the Minnelusa porosity value used for the RFOD calculation will be determined based on site-specific data according to Part II, Section B of the Class V Area Permit.</i></p>
55	---	---	23-28	4.4.1 4.4.2.2 5.4	R, C, A	<p><b>Comment:</b> Powertech repeats its concern that the Critical Pressure Rise calculations performed by EPA are incorrect and that the Cone of Influence (COI) data for Minnelusa-Madison are incorrect.</p>

Comment type key: **A** – alternate approach proposed; **C** – correct to be consistent with application, regulations or NRC license requirements; **E** – additional explanation requested; **I** – inconsistency (internally inconsistent between parts of Draft permit or supporting documents); **R** – remove; inconsistent with application, regulations or NRC license requirements; **T** – typographical error



**Table 1. Draft Class V Area Permit Specific Comments and Recommended Permit Language Revisions (Cont.)**

No.	Draft Permit		Fact Sheet		Type	Comment and Recommended Permit Language Revision or Other Modification
	Page	Section	Page	Section		
			36-37			<p>EPA interpreted Figure D-10 from the Class V permit application to indicate that the potentiometric surface of the Madison is at ground surface (Dewey Area) and 15 feet below ground surface (Burdock Area). As noted in the application (pp. 2-4 &amp; 2-5), this map was based on little (if any) local data. In fact, it shows the contours approaching the project area are “inferred”. Powertech used local data from the City of Edgemont wells to estimate the potentiometric surface of the Madison to be approximately 200 feet above ground surface, an estimate which is reasonable. The critical pressure rise was properly calculated on this basis in Tables 1 and 2 of the Class V permit application. It is noted that data now available for the closest state Madison observation well at Hell Canyon and shown in page 20 of the fact sheet, located approximately 9 miles away on the northwest side of the Dewey Fault, if extrapolated to the project area, indicate that the potentiometric surface of the Madison would be at least 50 to 100 feet above ground surface.</p> <p>Response: The 2019 Class V Fact Sheet contains information related to Version 2 of the Draft Class V Area Permit and will not be updated for the Final Class V Area Permit.</p> <p>EPA clarifies that The Permittee must calculate the critical pressure rise that is needed within each injection interval to move fluids into the Madison in accordance with Part II, Section F.1 of the Class V Area Permit. The Director will evaluate the information provided in the Injection Authorization Data Package Reports and may issue a written Authorization to Inject only after finding that the critical pressure rise and injection zone pressure calculations, considered together with the maximum injection rate permit limit, demonstrate that the injection well is located a sufficient distance from any feature that has the potential to serve as a pathway for fluid migration out of the injection zone into an USDW.</p> <p>Further, as previously noted, EPA incorrectly used maximum drawdown at the pumping well from the South Dakota DENR Report to the Chief Engineer on Water Permit Application No. 2685-2 (86.8 feet at Madison well at pumping rate of 551 gpm; Exhibit 001) and subtracted that depth from ground surface. Using this extreme scenario (which is 3.4 times the maximum rate needed by Powertech if Class V wells are drilled), the calculated drawdown at locations 1,000 feet distant from the pumping well is less than 35 feet after 20 years of continuous pumping at 551 gpm. In addition, as noted in the report, the calculation uses a transmissivity of 3,000 ft<sup>2</sup>/d, which is likely low for the area. It states that other local data indicate transmissivity values for the Madison as high as 7,393 ft<sup>2</sup>/d; therefore, drawdown could be even less.</p>

Comment type key: **A** – alternate approach proposed; **C** – correct to be consistent with application, regulations or NRC license requirements; **E** – additional explanation requested; **I** – inconsistency (internally inconsistent between parts of Draft permit or supporting documents); **R** – remove; inconsistent with application, regulations or NRC license requirements; **T** – typographical error



						<p>The report states that 551 gpm produced from the Madison is maximum usage rate in the event that Class V wells were not used for disposal. It goes on to state that the use of disposal wells would reduce the need for Madison fluid to approximately 160 gpm. In either case, the report states that Madison drawdown would not be significant or impact the area. The report notes that drawdown measured in wells near high capacity municipal wells in Spearfish, Sturgis and Rapid City has been only a few feet or tens of feet. Powertech notes that the seven high capacity wells in the Spearfish area that are documented by the state produce 500-2,200 gpm per well or 6,980 gpm in total (South Dakota DENR December 2013 evaluation of Spearfish public water system, Exhibit 007 at 4).</p> <p>Response: The 2019 Class V Fact Sheet contains information related to Version 2 of the Draft Class V Area Permit and will not be updated for the Final Class V Area Permit. EPA clarifies that if Madison water supply wells are constructed, the Permittee must generate a drawdown model for the Madison aquifer based on measurement of the potentiometric surface and other parameters as required by Table 7 and Part II, Section E.3.b of the Class V Area Permit.</p>
--	--	--	--	--	--	--

Comment type key: **A** – alternate approach proposed; **C** – correct to be consistent with application, regulations or NRC license requirements; **E** – additional explanation requested; **I** – inconsistency (internally inconsistent between parts of Draft permit or supporting documents); **R** – remove; inconsistent with application, regulations or NRC license requirements; **T** – typographical error





**Table 1. Draft Class V Area Permit Specific Comments and Recommended Permit Language Revisions (Cont.)**

No.	Draft Permit		Fact Sheet		Type	Comment and Recommended Permit Language Revision or Other Modification
	Page	Section	Page	Section		
56	---	---	31	Sec. 4.5	R	<p><b>Comment:</b> Powertech remains concerned about the way EPA states that Class I standards were applied “due to the nature of the activity.” Water will be treated to below 10 CFR Part 20 standards for release of radionuclides to the environment such that it cannot be classified as hazardous or radioactive material due to the permit conditions. Indeed, by regulation, the injectate should be classified as 11e.(2) byproduct material.</p> <p><b>Request:</b> Powertech requests explanation of the “nature of activity” and regulatory basis for the statement and application of Class I standards or removal of such references. Powertech requests that statements describing the injectate be classified appropriately as “byproduct material.”</p> <p><i>Response: The 2019 Class V Fact Sheet contains information related to Version 2 of the Draft Class V Area Permit and will not be updated for the Final Class V Area Permit. EPA clarifies that well construction must be in accordance with requirements presented in Part III of the Class V Area Permit and that injectate shall meet the permit limits set in Part V, Section D.2.a, Table 14 (formerly Table 16).</i></p>
57	---	---	31 32	5.1 Table 11	R	<p><b>Comment:</b> In Section 5.1, EPA explains the permeability and hydraulic conductivity values of the overlying confining layers that the EPA will consider adequate are on the scale of those found in Table 11. Powertech suggests confinement will be demonstrated also based on water quality and potentiometric surface data and not on permeability and hydraulic conductivity alone. Clarification regarding the process for determining adequacy of the permeability and hydraulic conductivity of the overlying confining zone are not within the scale of those shown in Table 11.</p> <p><b>Requested Change:</b> Powertech requests clarification regarding the process to be used if confining values are outside of the scale of those shown in Table 11.</p> <p><i>Response: The 2019 Class V Fact Sheet contains information related to Version 2 of the Draft Class V Area Permit and will not be updated for the Final Class V Area Permit. EPA clarifies that the range of confining values is not specified by the Class V Area Permit. In accordance with Part II, Section I of the Draft Class V Area Permit, the Director will evaluate the information provided in the Injection Authorization Data Package Reports and may issue a written Authorization to Inject only after finding that b. Laboratory analyses of core samples</i></p>

**Comment type key:** **A** – alternate approach proposed; **C** – correct to be consistent with application, regulations or NRC license requirements; **E** – additional explanation requested; **I** – inconsistency (internally inconsistent between parts of Draft permit or supporting documents); **R** – remove; inconsistent with application, regulations or NRC license requirements; **T** – typographical error



POWERTECH (USA) INC.

						<p>from the Opeche Shale upper confining zone demonstrate that confining zone permeability and hydraulic conductivity values are adequate for preventing migration of fluid out of injection zone; and c. For Madison water supply wells (if drilled): The laboratory analyses of Lower Minnelusa lower confining zone cores demonstrating that confining zone permeability and hydraulic conductivity values are adequate for preventing migration of fluid out of injection zone.</p>
58	---	---	---	---	C	<p><b>General Comment:</b> Powertech repeats its concern that calculations by EPA for Critical Pressure Rise, Diffusivity and Radius of Displacement were not accurate because values of porosity and potentiometric surface were not representative.</p> <p><b>Response:</b> The 2019 Class V Fact Sheet contains information related to Version 2 of the Draft Class V Area Permit and will not be updated for the Final Class V Area Permit. EPA clarifies that values of porosity and potentiometric surface will be determined according to Part II, Sections B and D, respectively, of the Class V Area Permit. These values will be used for representative calculations of critical pressure rise, diffusivity, and radius of displacement.</p>
<b>New Comments</b>						
59 – New Comment	Various			Various		<p><b>Comment:</b> Powertech plans to conduct phased construction at the Dewey-Burdock project over several years and currently plans to begin operations solely at the Burdock portion of the site consistent with its initial financial assurance calculations provided to the NRC in 2015. Powertech estimates that a Class V well will be constructed at the Dewey portion of the site approximately four to seven years after the initial start of operations. Powertech will ask for the authorization to construct, provide the suitable data package and provide financial</p>

Comment type key: **A** – alternate approach proposed; **C** – correct to be consistent with application, regulations or NRC license requirements; **E** – additional explanation requested; **I** – inconsistency (internally inconsistent between parts of Draft permit or supporting documents); **R** – remove; inconsistent with application, regulations or NRC license requirements; **T** – typographical error



**Table 1. Draft Class V Area Permit Specific Comments and Recommended Permit Language Revisions (Cont.)**

No.	Draft Permit		Fact Sheet		Type	Comment and Recommended Permit Language Revision or Other Modification
	Page	Section	Page	Section		
						<p>assurance guarantees for the well at Dewey once activities approach the Dewey portion of the site as provided for under Part III.J of the Revised Draft Class V Permit. The initial authorization and associated financial assurance should be for a single well at the Burdock portion of the site initially. The remaining three Class V wells are correctly included in the Revised Draft Class V Permit, but they should not be included in the initial financial assurance estimate.</p> <p><b>Requested Change:</b> Powertech requests that the initial authorization and associated financial assurance estimate is for a single Class V well at the Burdock portion of the site. For each subsequent Class V well, Powertech will update the financial assurance estimate 90 days prior to the start of construction.</p> <p><i>Response: EPA made clear in its Fact Sheet for its 2019 Draft Class V Permit (see Section 10.3) that an initial adequate demonstration of financial responsibility (FR) would be required prior to final UIC permit issuance. This is consistent with EPA’s UIC regulatory authority found in 144.52(a)(7), which gives the UIC Director discretion to require FR for Class V wells including when an appropriate demonstration should be made. Requiring FR from UIC Permittees prior to final UIC permit issuance is also consistent with EPA’s longstanding practice for the proposed operation of relatively deep disposal wells. In this case, this demonstration was made by the Permittee for one deep Class V disposal well in the amount of \$133,208 in the form of fully funded trust, in cash. Financial assurance for any additional Class V wells under this Area Permit will be required prior to EPA authorizing construction of these wells.</i></p>
60 – New Comment			22	3.4	T	<p><b>Comment and Requested Change:</b> Sulfur is misspelled twice in the first paragraph. Request it be changed to sulfur.</p> <p><i>Response: No change is necessary as the Class V Fact Sheet will not be updated for the Final Class V Area Permit.</i></p>

Comment type key: **A** – alternate approach proposed; **C** – correct to be consistent with application, regulations or NRC license requirements; **E** – additional explanation requested; **I** – inconsistency (internally inconsistent between parts of Draft permit or supporting documents); **R** – remove; inconsistent with application, regulations or NRC license requirements; **T** – typographical error



POWERTECH (USA) INC.

61 – New Comment	20	III.C.2	43	7.3	I, A	<p><b>Comment:</b>  The permit indicates any changes in well construction after initial well construction (draft permit) or after well construction is complete (draft fact sheet) will be considered major modifications, including the addition of perforations, according to 40 CFR 144.39 and 40 CFR 124.5. Powertech notes the use of the word “initial” or the phrase “after well construction is complete” are not found in the referenced regulations. Instead, the referenced regulations indicate changes in well construction may be approved by the Director as minor modifications “during construction.” Powertech suggests this provides for minor modifications in well construction at times when construction consistent with approved plans is performed rather than being limited to an undefined “initial” period of construction or after reaching an undefined milestone where “well construction is complete.” Perforating new intervals within the approved injection zone is a continuation of approved well construction. Perforating in the approved injection zone and other construction consistent with the approved plans should therefore be accepted as minor modifications of the permit.</p> <p><b>Requested Change:</b>  Powertech requests the following language be added to III.C.2 to allow for changes in well construction throughout the duration of well performance in accordance with the regulation: “The permittee has the flexibility to make changes in construction by means of a minor modification with the approval of the Director as long as the resulting Class V well construction is consistent with Federal UIC regulations and Part III of this Permit and so long as no change is made prior to approval by the Director. Allowable minor modifications</p>
------------------	----	---------	----	-----	------	--

Comment type key: **A** – alternate approach proposed; **C** – correct to be consistent with application, regulations or NRC license requirements; **E** – additional explanation requested; **I** – inconsistency (internally inconsistent between parts of Draft permit or supporting documents); **R** – remove; inconsistent with application, regulations or NRC license requirements; **T** – typographical error



**Table 1. Draft Class V Area Permit Specific Comments and Recommended Permit Language Revisions (Cont.)**

No.	Draft Permit		Fact Sheet		Type	Comment and Recommended Permit Language Revision or Other Modification
	Page	Section	Page	Section		
						<p>include, but are not be limited to, adding perforations in the permitted injection zone and running a liner.”</p> <p>Response: According to 40 CFR § 144.39 and § 124.5, any changes after initial well construction is complete require a major modification of the permit. EPA does not have flexibility to allow such changes as minor modifications. EPA agrees that the addition of perforations to an approved injection zone after completing initial construction is consistent with the intended allowable construction specifications, and the Class V Area Permit has been revised to reflect this (see response to comment #28). However, because well liners can take different forms, additional information is needed in order to include a provision for a liner under approved specifications for well construction in Part III. Therefore, the Class V Area Permit has not been revised to include specifications for a liner.</p>
62 – New Comment	44-45	IX.B	60	11.2	A	<p><b>Comment and Requested Change:</b> Powertech requests clarification on the basis of a 1-mile avoidance buffer for the whooping crane, rufa red-knot and northern long-eared bat and how this was determined to be protective. Such a buffer appears to be much greater than typical wildlife buffers and was formulated without basis within the documents provided. From the documents provided, it appears that the buffer was arbitrarily increased from 1/4 mi to 1 mile by EPA and applied to other species arbitrarily. Powertech recommends that a mitigation plan be allowed to be developed upon observation of these species. Such a plan could involve various strategies to avoid a take.</p> <p>Response: EPA changed its proposed distance from one mile to one-half mile. After further consultation with the FWS, EPA determined that one-half mile strikes a better balance between the ability to positively identify a listed species and maintaining a distance that still provides an adequate buffer to protect these species. Upon advice of the FWS, EPA clarified that upon sighting of a listed species, the Permittee must also work with a qualified biologist to ensure protection of these species (which could include additional mitigation). Finally, EPA clarified how the Permittee should be in contact with EPA and the FWS in implementing all mitigation measures.</p>

Comment type key: **A** – alternate approach proposed; **C** – correct to be consistent with application, regulations or NRC license requirements; **E** – additional explanation requested; **I** – inconsistency (internally inconsistent between parts of Draft permit or supporting documents); **R** – remove; inconsistent with application, regulations or NRC license requirements; **T** – typographical error



**POWERTECH (USA) INC.**

63 – New Comment	44-45	IX.B.1	60	11.2	A	<p><b>Comment and Requested Change:</b>            Powertech requests modification of the requirement that all operations and construction must cease within 1 mile upon sighting a whooping crane, rufa red-knot or northern long-eared bat. In particular, active operations cannot be immediately ceased as this could endanger protection of USDWs as operations are required to be manned. As well, this could create serious issues with compliance conditions within the Class III permit, for example, the need to continuously maintain a bleed on the wellfield. Powertech recommends that a mitigation plan be allowed to be developed upon observation of these species. Powertech questions the authority of the EPA to enforce such requirements. Such conditions are enforceable under the South Dakota DENR Large Scale Mine Permit, and Powertech believes these requirements are better applied in this fashion, with direct interaction with SD GFP, where trained wildlife biologists can determine an appropriate approach.</p> <p><b>Response:</b> In addition to EPA changing the buffer for listed species protection from one mile to one-half mile (see Response #62), EPA modified its proposed measure by requiring that only construction activities cease, not wellfield operations. This change recognizes that surface disturbing activities are more likely to adversely impact listed species than subsurface activities. Upon advice of the FWS, EPA also clarified that upon sighting of a listed species, the Permittee must also work with a qualified biologist to ensure protection of these species (which could include additional mitigation). EPA’s authority to enforce these mitigation measures comes from 40 CFR 144.52(a) which states that, “the Director shall establish (permit) conditions, as required on a case by case basis under...Section 144.4 (considerations under Federal law)” which includes the Endangered Species Act (ESA). EPA has determined that such measures, in consultation with the FWS, are necessary to ensure protection of listed species within the Project Area and must enforce these measures independent of other regulatory authorities to fulfill its own obligation to comply with the ESA.</p>
64 – New Comment	45	IX.B.5	61	11.2	A	<p><b>Comment and Requested Change:</b>            This condition appears arbitrary and not tied to the known presence of wildlife of concern. Powertech suggests that this condition be modified so that if a whooping crane, rufa red-knot or northern long-eared bat have been confirmed at the site by trained wildlife biologist, then such a condition would be applied if deemed appropriate by a trained wildlife biologist.</p> <p><b>Response:</b> To address this comment, EPA elected to modify the following proposed measures in the 2019 draft UIC Permits to read:            “In the event that construction is planned during the whooping crane and rufa red knot migration seasons or the NLEB active season, within five days prior to the initiation of any construction activities, a qualified biologist must conduct pre-construction surveys for these species and training for workers to assist with the identification of all listed species during construction and operation.”            “If the whooping crane, the rufa red knot or the northern long-eared bat are sighted within</p>

**Comment type key:** **A** – alternate approach proposed; **C** – correct to be consistent with application, regulations or NRC license requirements; **E** – additional explanation requested; **I** – inconsistency (internally inconsistent between parts of Draft permit or supporting documents); **R** – remove; inconsistent with application, regulations or NRC license requirements; **T** – typographical error



POWERTECH (USA) INC.

						<p>one-half mile of the well sites or associated facilities during construction or operation, the Permittee must contact EPA and the FWS immediately and all construction work within one-half mile of the species' location must cease. Powertech will work with the FWS and a qualified biologist to minimize surface operation activities within one-half mile of the species' location. In coordination with the FWS, work may resume after the species leave the area. For this measure and other ESA-related matters related to this project, the Permittee should contact the FWS and EPA by phone, followed up by an e-mail.</p> <p>A. Whooping Crane Migration Seasons: Migrates through South Dakota April 1 to mid-May and mid-September to mid-November.</p> <p>B. Rufa Red Knot Migration Seasons: Migrates through South Dakota mid-April to mid-May and mid-September to October 31.</p> <p>C. NLEB Active season: Mid-April to October 31. The critical pup season is June 1 – July 31.”</p> <p>For the first measure noted above, EPA determined after consulting with the FWS that training onsite personnel to assist with identification of a listed species within the Project Area would better ensure that such species are protected. Upon advice of the FWS, EPA also clarified in the second measure noted above that upon sighting of a listed species, the Permittee must also work with a qualified biologist to ensure protection of these species. Finally, EPA clarified how the Permittee should be in contact with EPA and the FWS in implementing all mitigation measures.</p>
65 – New Comment	44-45	IX.B	60	11.2	A	<p><b>Comment and Requested Change:</b></p> <p>From the biological assessment documents provided, it does not appear that the EPA sought specific input on the parameters of mitigation for the whooping crane and rufa red-knot prior to creating permit requirements. Powertech requests clarification on the Section 7 consultation with the Secretary of the Interior (U.S. Fish and Wildlife Service). Are the</p>

Comment type key: **A** – alternate approach proposed; **C** – correct to be consistent with application, regulations or NRC license requirements; **E** – additional explanation requested; **I** – inconsistency (internally inconsistent between parts of Draft permit or supporting documents); **R** – remove; inconsistent with application, regulations or NRC license requirements; **T** – typographical error



**Table 1. Draft Class V Area Permit Specific Comments and Recommended Permit Language Revisions (Cont.)**

No.	Draft Permit		Fact Sheet		Type	Comment and Recommended Permit Language Revision or Other Modification
	Page	Section	Page	Section		
						<p>mitigation measures described in the draft permit a result of this consultation? If not, Powertech requests that this section be revised once consultation has been completed.</p> <p>Response: EPA consulted with the FWS on July 16, 2020 and discussed appropriate mitigation measures to include in EPA's Biological Assessment (BA). On August 4, 2020, EPA requested concurrence from the FWS on this BA which included the mitigation measures to be enforced in EPA's UIC Permits. On August 6, 2020, the FWS provided written concurrence with EPA's determination that these measures were necessary to ensure that its actions may affect, but are not likely to adversely affect, the rufa red knot, northern long-eared bat and whooping crane.</p>
66 – New Comment	45	IX.B.8	61	11.2	A	<p><b>Comment and Requested Change:</b> Powertech requests clarification on the frequency of the motion-activated camera monitoring. Powertech requests clarification that additional monitoring will not be required if the shaft entrance is covered following a determination that no bats are inside the shaft.</p> <p>Response: After consulting with the FWS, EPA did not modify the proposed measure in response to this comment based on a reasonable conclusion that additional monitoring will not be required if the shaft entrance is covered following a determination that no bats are inside the shaft.</p>

Comment type key: **A** – alternate approach proposed; **C** – correct to be consistent with application, regulations or NRC license requirements; **E** – additional explanation requested; **I** – inconsistency (internally inconsistent between parts of Draft permit or supporting documents); **R** – remove; inconsistent with application, regulations or NRC license requirements; **T** – typographical error



**Powertech Comment Table on Cumulative Effects Analysis with EPA Responses**

**Powertech’s comment key:** **A** – alternate approach proposed; **C** – correct to be consistent with application, regulations or NRC license requirements; **E** – additional explanation requested; **I** – inconsistency (internally inconsistent between parts of Draft permit or supporting documents); **R** – remove; inconsistent with application, regulations or NRC license requirements; **T** – typographical error

No.	Page	Section	Type	Comment and Requested Modification	R8 EPA annotation	Added comment to RtC document	Revised CEA section
C3	6	3.1.1	C	<p>The statement is made that “During groundwater restoration, contaminated water is pumped from the wellfield injection interval, treated with reverse osmosis, and most of the clean permeate from the reverse osmosis treatment process is reinjected.” Powertech requests clarifying that reverse osmosis would only be used in the deep disposal well option.</p> <p><b>RtC and revision in CEA:</b> At this point in the document, the two disposal options for waste fluids has not been discussed, so some explanation needs to be added here.</p> <p>Replace the yellow-highlighted sentence above with: “During groundwater restoration, the amount of Inyan Kara groundwater that is recirculated, as opposed to withdrawn and not returned to the aquifer, depends on the waste fluid disposal method. If waste fluids are injected into the Class V injection wells for disposal, contaminated groundwater pumped from the wellfield injection interval during groundwater restoration will be treated with reverse osmosis. The clean permeate from the reverse osmosis treatment process will be reinjected. If Powertech is not able to use the Class V injection well option for the disposal of waste fluids, then the water that is withdrawn from the wellfield injection interval during groundwater restoration will not be returned to the aquifer.</p>	T: agree with revision	yes	Revised CEA 3.1.1 with language at left.
C4	8	3.1.1	I	<p>The statement is made that “during operations, Powertech will take over control of all Inyan Kara wells located inside the project boundary.” This is inconsistent with Section 3.2.1.1 of this document, which correctly states that Powertech will remove all drinking water wells within the project boundary from drinking water use and remove all stock wells within ¼ mile of wellfields from private use. Powertech requests correcting the inconsistency.</p> <p><b>Revision in CEA:</b> Change this sentence at the bottom of page 8: “As discussed later in Section 3.2.1.1, during operations, Powertech will take over control of all Inyan Kara wells located inside the project boundary” to “As discussed later in Section 3.2.1.1, during operations, Powertech will remove all drinking water wells within the project boundary from drinking water use and remove all stock wells within ¼ mile of wellfields from private use.”</p>	T: Agree with the revision	no	Revised CEA 3.2.1.1 with language at left

C5	9	3.1.1	I	The statement is made that “if any [private Inyan Kara wells] are located close to an ISR wellfield and cause a breach in a confining zone ... Powertech will provide an alternative water source to well owners by installing a Madison water supply well, as discussed in Section 3.2.1.1.” The referenced section discusses two options for replacing a private well: installing a replacement well or alternate water supply such as a pipeline from a Madison well. A replacement well would not necessarily be installed in the Madison aquifer. For example, it could be installed in the Sundance/Unkpapa aquifer. Powertech requests updating this discussion for consistency with commitments in the Class III permit application.	Agree that need not specify that the alternative water supply is from Sundance	yes	Revised CEA 3.1.1 by striking out “Madison” in: “Powertech will provide an alternative water source to well owners by installing a Madison water supply well, as discussed in Section 3.2.1.1.”
C6	10	3.1.2	T	In the last paragraph on this page, Powertech requests correcting typographical errors as follows: “Table 6 is Table 2-1 in Powertech’s Report to Accompany Madison Water Right Permit Application shows a different breakout of the maximum estimated Madison usage as shown in Table 54. The maximum anticipated Madison usage is one gallon per minute more in Table 65 than in Table 54.”	T: agree with revision	yes	Revised CEA 3.1.2 per comment
C7	11	3.1.2	T	In the last sentence on this page, Powertech requests correcting a typographical error as follows: “Therefore, the EPA finds that the impacts from Powertech’s proposed net withdrawal of Madison Inyan Kara groundwater will not affect the availability of groundwater for other Madison groundwater users.”	T: agree with revision	no	Revised CEA
C8	12	3.2.1	C	The statement is made that “The EPA reviewed the information Powertech provided about the potentiometric surface drawdowns of the Inyan Kara Aquifers expected from the maximum gross pumping rate of 8,500 gpm.” Since it is the net pumping rate and not the gross pumping rate that affects drawdown, Powertech requests correcting this as follows: “The EPA reviewed the information Powertech provided about the potentiometric surface drawdowns of the Inyan Kara Aquifers expected from the maximum net gross pumping rate of 170 <del>8,500</del> gpm Powertech is requesting from the DENR Water Rights Program.”	Agree with revision	yes	Revised CEA 3.2.1 with edits at left

C9	12 15	3.2.1 3.2.1.2	I	<p>The statement is made that “the potentiometric surface elevations are expected to recover to within one to two feet at the locations of the pumping well after <u>decommissioning of the project</u>” (emphasis added). This is inconsistent with the permit application and Section 3.2.1.2 of this document, which correctly states that the elevations are expected to recover within one to two feet after ISR operations end, as opposed to after decommissioning, which may take years after ISR operations end depending on the length of stability monitoring, regulatory approval of successful groundwater restoration, and post-restoration groundwater monitoring, if required. This comment also applies to the similar statement on the bottom of page 15. Powertech requests changing “after decommissioning of the project” to “after ISR operations” in both instances.</p> <p><b>RtC and revision in CEA:</b> EPA has revised to state instead: “...the potentiometric surface elevations are expected to recover to within one to two feet at the locations of the pumping well <b>after the completion of groundwater restoration of the project</b>” and replaced “after decommissioning of the project” with the emphasized language.</p>	Agree, but edited CEA with alternative language than Powertech proposed	yes	Revised 3.2.1 and 3.2.1.2 in both areas per the revised language at left.
C10	17	3.2.2	I	<p>The statement is made that estimated drawdown of the Madison aquifer at 551 gpm pumping is “86.8 feet at the Dewey-Burdock site.” Powertech requests clarifying that this is the estimated drawdown at the pumping well, not across the project site. This is correctly stated on page 18, which indicates that the DENR “calculated the drawdown in the Madison aquifer potentiometric surface from the Madison water supply wells to be 86.8 feet at the well locations within the Dewey-Burdock Project Area.”</p> <p><b>Revisions made:</b> “551 gpm from the Madison aquifer...the graphs shows a drawdown of the aquifer water level of 86.8 feet <b>at the well locations within the Dewey-Burdock Project area.</b>”</p>	I: Agree	yes	CEA revision made in 3.2.2 per redlines at left
C11	19	3.3.1	C	<p>The statement is made that “The NRC license requires Powertech to conduct groundwater restoration to the wellfield injection zone to restore the groundwater to <u>pre-ISR conditions</u>” (emphasis added). While it would be appropriate to characterize the NRC restoration requirements as consistent with pre-ISR conditions, the requirements in 10 CFR Part 40, Appendix A, Criterion 5B(5) are to restore the water to baseline or an MCL, whichever is higher, or an ACL through the rigorous ACL approval process. Powertech requests correcting this statement as follows: The NRC license requires Powertech to conduct groundwater restoration to the wellfield injection zone to restore the groundwater to <b>meet 10 CFR Part 40, Appendix A, Criterion 5B(5) requirements pre-ISR conditions.</b></p>	Agree; but included info. from Criterion 5B(5).	yes	CEA revision made in 3.3.1 per comment, but also added information from Criterion 5B(5).

C12	26	3.3.4	T	Powertech requests correcting “Burdock pond designs” to “Dewey-Burdock pond designs”.	T: agree with revision	no	Edit made
C13	29	Fig. 9b	T	Powertech requests correcting “HDPA liner” to “HDPE liner”.	T: agree with revision	no	Edit made
C14	32	Fig. 12a	T	Powertech requests correcting “HDPA liner” to “HDPE liner”.	T: agree with revision	no	Edit made
C15	32	Fig. 12b	T	Powertech requests correcting “HDPA liner” to “HDPE liner”.	T: agree with revision	no	Edit made
C16	33	Fig. 13a	T	Powertech requests correcting “HDPA liner” to “HDPE liner”.	T: agree with revision	no	Edit made
C17	33	Fig. 13b	T	Powertech requests correcting “HDPA liner” to “HDPE liner”.	T: agree with revision	no	Edit made
C18	34	3.3.4.2	E	No justification appears to be provided for the statement that a leak from a pond storing treated water will result in “extensive impact ... which will be difficult and expensive to remediate” by the time the leak is detected in the pond detection monitoring system required by the NRC. The pond detection monitoring system required by License Condition 12.25 in SUA-1600 will be designed as an early warning system using non-hazardous indicator parameters, similar to what is done for excursion monitoring in the wellfields. Based on this requirement, the fact that the ponds with single HDPE liners overlying clay liners will only store treated water, and the fact that the ponds will be about 1 mile away from Pass Creek, there is a low likelihood of an “extensive impact” from a pond leak. Powertech requests revising this discussion to address these considerations.	Disagree	yes	
C19	36	3.3.4.2	C	See comments #C1 and #C42. The statement that “subpart W ... requires that there be no more than two ponds, each with a surface area of no more than 40 acres that are in operation at any given time” is not supported by the final subpart W rule. Powertech requests updating this discussion.	This comment is already reflected in comment Subpart W of the response to comments	no	

					document		
C20	37	3.5	C	<p>Powertech requests adding to the list of mitigation measures to prevent groundwater impacts the groundwater detection monitoring plan required by NRC License Condition 12.25 (Exhibit 016 at 14-15).</p> <p><b>Revision in CEA:</b> Insert the following statement as bullet #6 in the list of migration measures in Section <b>3.5 Summary of Mitigation Measures to Prevent Groundwater Impacts:</b> 6. The NRC license requires development of a leak detection monitoring plan specifying the number, locations, and screen depths of groundwater monitoring wells that will be installed around the Burdock area and Dewey area ponds.</p>	Agree	yes	Revised 3.5 per revisions at left
C21	38	3.5	T	<p>Powertech requests removing "as" in "designated monitoring wells <del>as</del> during operations" in the number 8 listed at the top of this page.</p>	T: agree with revision	no	Edit made
C22	38	4.0	I	<p>In the second paragraph in Section 4.0 and various locations throughout the document, Powertech's Large Scale Mine Permit application is incorrectly referenced as "the South Dakota DENR Large Scale Mine Permit." Since the permit has not yet been issued pending completion of the state hearing, Powertech requests changing all references to the Large Scale Mine Permit Application, which is done correctly at some locations within the document (e.g., at the bottom of page 36).</p>	T: disagree with revision; instead edited to say "proposed permit" because SD had conditionally approved the permit in 2013	no	Edit made

C23	43	4.2.3	T	In the 2 <sup>nd</sup> sentence in this section, Powertech requests correcting “Table 8” to “Table 7”.	T: agree with revision. Table 8 refers to Sediment Structures Planned for Use at the Dewey-Burdock Project Site and Corresponding Drainage Basin Acreage.	no	Edit made
C24	43	4.2.3	T	In the 2 <sup>nd</sup> to last paragraph on this page, 5 <sup>th</sup> line, Powertech requests correcting a typographical error as follows: “and 5.3-7 provide the locations of planned ephemeral stream channels <b>diversions</b> within the permit area.”	T: agree with revision	no	Edit made
C25	48 70	4.5 6.0	C	The statement is made that “Powertech will use a phased approach to wellfield development beginning with wellfield 1 in the Dewey and Burdock Areas.” See comment #F8 in Table 2, which describes how this statement is inconsistent with Section 10.10 (p. 10-13) of the Class III permit application, which states that Powertech may develop either the Burdock or Dewey area wellfields first, followed by those in the other area. Powertech’s current plans include developing Burdock area wellfields prior to those in the Dewey area (Exhibit 026). This comment also applies to a similar statement on page 70. Powertech requests updating the text on p. 48 as follows: Powertech will use a phased approach to wellfield development beginning with wellfield 1 in the Dewey and Burdock Areas. <b>The Burdock-B-WF1 wellfield and Dewey-D-WF1 wellfield will be constructed during the initial construction phase of the project.</b> Alternately, Powertech may develop either the Burdock or Dewey wellfields first, followed by those in the other area.  Similarly, Powertech requests updating the text on p. 70 as follows: Powertech anticipates that the initial construction of processing facilities, infrastructure (e.g., pipelines, access roads, power lines, and storage ponds), and the two initial wellfields is expected to be completed within two years.	Agree with revision; wasn’t clear in permit application, so this is a clarification	yes	Edits made per PT’s comment in CEA Section 3.5 and 6.0

				<p>Powertech will develop the wellfields in a progressive manner, beginning with Dewey and Burdock wellfields #1. <b>Alternately, Powertech may develop the wellfields and processing facilities in either the Dewey or Burdock area first, followed by those in the other area.</b></p>			
C26	51	4.6	T	<p>In the last sentence in this section, Powertech requests changing the reference from Section 5.4 to Section 4.8, which lists mitigation measures for surface water quality impacts.</p>	<p>T: agree with revision b/c 5.4 refers to Deep Well Pump and Wellhead Houses</p>	no	<p>Edit made in CEA 4.6</p>
C27	52	4.7.1	I	<p>The statement is made that the 243 acres of land disturbance anticipated under the deep well liquid waste disposal option includes “initial wellfields.” Powertech requests correcting this to “all wellfields” for consistency with Table 10 and Section 6.0.</p>	<p>I: Agree with revision. Would be consistent with the total for Class V acres in Table 10, and also Section 6.0 (excerpt below)</p>	no	<p>CEA edit made in 4.7.1</p>
C28	52	4.7.1	T	<p>In the 3<sup>rd</sup> paragraph, 4<sup>th</sup> line, Powertech requests correcting a typographical error as follows: “... measures to ensure that injection zone fluids will be vertically confined and injection will not <b>result</b> in the migration of ...”</p>	<p>T: Agree with revision</p>	no	<p>Edit made in CEA 4.7.1</p>
C29	55	4.8	T	<p>In list item #5, Powertech requests correcting a typographical error as follows: “Maintain natural contours as much as possible, stabilizing slopes and avoiding unnecessary off-road travel with vehicles; <del>maintaining natural contours as much as possible, stabilizing slopes and avoiding unnecessary off-road travel with vehicles.</del>”</p>	<p>T: Agree with revision</p>	no	<p>Edit made in CEA 4.8</p>

C30	55	5.0	C	<p>In the 2<sup>nd</sup> paragraph, the statement is made that “To mitigate impacts from spills and leaks and to prevent long term impacts, the DENR NPDES permit will require Powertech to develop an Emergency Preparedness Program under the project Environmental Management Plan.” Powertech requests correcting this statement to reflect that the Environmental Management Plan is a requirement of the NRC license rather than the DENR NPDES permit. This comment also applies to similar statements on pages 62, 67 and 74.</p> <p><b><u>CEA Revision:</u></b> Powertech refers to an Environmental Management Program in the Technical Report. So add “...and the NRC license requires development of an Environmental Management Plan as referenced in the Technical Report included in the License application.”</p>	I: Agree with revision	yes	<p>Edit made in CEA 5.0</p> <p>And also similar changes in 5.5.1, 5.8, 7.2 and 13.2</p>
C31	68	6.0	T	In the 1 <sup>st</sup> paragraph, 9 <sup>th</sup> line, Powertech requests correcting “2.394 acres” to “2,394 acres”.	T: Agree with revision	no	Edit made in CEA 6.0
C32	70	6.0	T	In the 1 <sup>st</sup> paragraph, last line, Powertech requests correcting “Table 7” to “Table 11”.	T: agree with revision	no	Edit made in CEA 6.0
C33	71	6.0	T	In the last line in this section, suggest correcting “there should be there should be”.	T: Agree with revision	no	Edit made in CEA 6.0
C34	71	7.0	T	In this last line of the 1 <sup>st</sup> paragraph in this section, Powertech requests correcting “there should be <del>there should be</del> ”.	T: Agree with revision	no	Edit made in CEA 7.0
C35	76	7.4.1	I	In the 2 <sup>nd</sup> paragraph, the statement is made that “Powertech estimates the maximum volume of liquid wastes injected into the deep injection wells during aquifer restoration will be 155 gpm (see Section 3.1.1 of this document).” The reference to Section 3.1.1 is for estimated Inyan Kara water consumption during concurrent operations and aquifer restoration, rather than the maximum injection volume. The correct maximum volume of liquid waste injection during concurrent operations and aquifer restoration is 232 gpm, as stated on page 144 (3 <sup>rd</sup> paragraph) of this document. That amount is consistent with	I: Agree with revision, see last paragraph in section 15.3.1	yes	Edit made CEA 7.4.1



				Figure 7.1 of the Class III permit application and Table 5.3-2 of the Large Scale Mine Permit Application. Powertech requests correcting this statement as follows: Powertech estimates the maximum volume of liquid wastes injected into the deep injection wells during aquifer restoration will be <del>232 155</del> gpm (see Section <del>15.3.1.1</del> of this document).			
C36	76	7.4.2	C	In the 1 <sup>st</sup> paragraph in this section, the statement is made that “Powertech estimates that typical liquid waste flow rates during groundwater sweep under the land application option during aquifer restoration will be approximately 507 gpm as shown in Table 5, Section 3.1.2 of this document.” Similar to the last comment, the reference to Section 3.1.2 is for estimated Madison usage, not wastewater disposal requirements under the land application option. Figure 7.1 of the Class III permit application and Table 5.3-2 of the Large Scale Mine Permit Application show that the maximum anticipated liquid waste flow rate during concurrent operations and aquifer restoration under the land application option is 582 gpm. Powertech requests correcting this statement as follows: Powertech estimates that typical liquid waste flow rates during groundwater sweep under the land application option during aquifer restoration will be approximately <del>507</del> 582 gpm as <del>described shown</del> in <del>Table 5</del> , Section <del>15.3.1.2</del> of this document.	I: Agree with revision in part: gpm figure should be 582 as PT proposes, but the reference to 15.3.2. is incorrect, and instead the 582 gpm figure is a reference to Figure 7.1 of PT’s class III permit application.	yes	Rtc and edits made
C37	79	7.6	E	In bullet #e, Powertech requests clarifying that “Table 5.4-3” refers to the DENR Large Scale Mine Permit Application in the following statement: “The concentrations of metals and metalloids, including arsenic and selenium, are anticipated to be low as shown in Table 5.4-3.”	T: agree with revision	no	Edit made in CEA 7.6
C38	79	7.7	T	In the 2 <sup>nd</sup> line under Section 7.7, Powertech requests correcting “Section 7.2” to “Section 7.6”.	T: agree with revision	no	Edit made in 7.7

C39	80	8.1	C	The statement is made that “The Class III injection, production and monitoring wells will have casing screen.” As described under comment #29 in Table 1, Section 11.2 of the Class III permit application specifies that the well screen assembly and filter sand may or may not be used. The omission of well screen and filter sand would only be done where the screened interval was sufficiently competent; therefore, there would be no impacts to geology with or without the well screen. Powertech requests deleting this sentence.	T: Agree with revision	yes	Edits made and in RTC
C40	82	8.2.2	T	In the last paragraph in this section, 3 <sup>rd</sup> line, Powertech requests correcting “injection-induced” to “injection-induced <b>seismicity</b> ”.	T: agree with revision	no	Edit made
					EPA notes that C41 is missing and it skips to C42	no	
C42	102	10.3.3	C	Powertech requests updating the statement that “EPA is considering revisions to 40 CFR Part 61, subpart W” in light of the final rule release in January 2017. It is also suggested to update the discussion to reflect the provisions in the final rule, especially that there are no longer maximum size limits or maximum number of impoundments for non-conventional impoundments such as would be constructed at the Dewey-Burdock Project. Powertech requests clarifying for the public the determination in the final rule that radon emissions from non-conventional impoundments that maintain a minimum liquid level are nearly indistinguishable from background. Since Powertech will treat the wastewater to remove radium and its byproducts, radon emissions from treated water storage ponds will be minimal. Powertech also requests updating the discussion to recognize its November 2014 commitments regarding modifications to the pond designs to comply with final subpart W provisions (Powertech 2014; Exhibit 032). In response to a request from EPA staff, Powertech committed to modifying the single-lined wastewater storage and treatment impoundments in the Burdock area to minimize the potential for contamination to reach alluvial groundwater. That letter also documents NRC staff’s determination that the existing pond designs are adequately protective of human health and the environment and the NRC license conditions related to pond leak detection monitoring, routine pond inspections and development of a standard operating procedure (SOP) for potential pond releases. In addition, Powertech requests that EPA document Powertech’s commitment in its November 2014 letter to submit an application to EPA for approval to construct wastewater storage and treatment impoundments at least 60 days prior to construction of the impoundments. This application was not submitted previously to EPA due to the risk that it would	Agree in part, CEA Update per rule revisions	yes	Edits made and in RTC

				further delay the UIC permitting process, which has already taken more than 8 years yet is incomplete, and due to the uncertainty in the provisions of the final subpart W rule, which was not released until January 2017.			
C43	103	10.4	T	In the numbered list at the top of this page, it appears that the sentence beginning “The presence of Class I areas” should be bullet #3.	T: agree with revision	no	Edit made
C44	103	10.4	C	In the paragraph above Section 10.4.1, the statement is made that “The peak year accounts for the time when all four ISR project life-cycle phases (construction, operations, aquifer restoration, and decommissioning) are occurring simultaneously and represents the highest amount of emissions the project will generate in any one year.” If post-restoration groundwater monitoring is required for this project, it would delay decommissioning by many years if not decades, such that the decommissioning phase would not overlap with any of the other project phases. Therefore, this worst-case scenario would not occur. Powertech requests updating this discussion if post-restoration groundwater monitoring is required.	Post-restoration monitoring is no longer required	yes	No edit in CEA made. But comment addressed in RTC
C45	104	10.4.1	C	In the 1st paragraph, the statement is made that “the NRC ... did not use the most recent regulatory-approved version of the [AERMOD and CALPUFF] model software platforms.” The AERMOD version used by IML Air Science (IML) in the project modeling was updated by IML’s software vendor, Lakes Environmental, multiple times after the original modeling protocol was developed. As a practical matter, any model version is likely to be out of date by the time an EIS is published. This is particularly true when follow-up model runs are required. The important consideration is that the versions of AERMOD and its associated software tools were current and mutually compatible when the model was implemented, and that to preserve comparability the model was not changed mid-stream. Powertech requests updating the discussion to document that the versions of AERMOD and its associated software tools were current and mutually compatible when the model was implemented.	Agree with revision	yes	Deleted “did not use the most recent regulatory-approved version of the model software platforms” in CEA
C46	104	10.4.1	C	In the 2nd paragraph, the statement is made that “EPA did not find that NCR [sic] provided sufficient information to support the use of dry depletion in the AERMOD analysis.” Precedent has been established by state and federal agencies for using the dry depletion option in AERMOD to model short-term impacts from fugitive dust emissions. For example, a coal lease application in Utah triggered PM10 modeling that included a refined analysis using deposition and plume depletion (IML 2013; Exhibit 033). Page 9 of	Disagree. No revision made in CEA.	yes	No CEA revision made

				<p>Appendix K in the Alton Coal Lease DEIS states, “deposition was only considered for assessing the final PM10 modeled ambient air impacts. Deposition was not considered for any other pollutants ...” Page 10 states, “the primary pollutants of concern are fugitive dust.” (BLM 2015; Exhibit 034).</p> <p>The Colorado Department of Public Health and Environment (CDPHE) uses dry depletion to model PM10 impacts from fugitive dust sources at mining facilities seeking air quality construction permits (IML 2013; Exhibit 033). Recent projects for which this option was used include the Lafarge Gypsum Ranch Pit, Oxbow Mining’s Elk Creek Mine, and Bowie Resources’ Bowie N.2 Mine. The Wyoming Department of Environmental Quality stated that it would accept the use of plume depletion algorithms in AERMOD as long as an applicant justifies the inputs, including particle size, particle density and mass fraction (IML 2013; Exhibit 033). Both Colorado and Wyoming operate EPA-approved air permitting and enforcement programs.</p> <p>A recent modeling analysis was triggered by high fugitive dust impacts in the Salt River area of Arizona. Maricopa County was reclassified as a serious PM10 nonattainment area on June 10, 1996. The primary sources of particulate pollution in this area are “fugitive dust from construction sites, agricultural fields, unpaved parking lots and roads, disturbed vacant lots and paved roads” (IML 2013; Exhibit 033). Cited among the “general characteristics that make AERMOD suitable for application in the Salt River Study area” is the claim that “gravitational settling and dry deposition are handled well.” Powertech requests that EPA update this discussion in light of the evidence presented in this comment.</p>			
C47	104	10.4.1	C	<p>In the 2nd paragraph, the statement is made that “The dry depletion option may be appropriate to use in AERMOD when sufficient data are available to determine the particle size distribution and other particle information reasonably well for each source.” Powertech asserts that sufficient justification was provided in the IML 2013 modeling (Exhibit 033), as summarized below.</p> <p>The original PM10 particle size distribution was obtained from the modeling protocol for the Rosemont Mine in Arizona (IML 2013; Exhibit 033). The modelers for the Rosemont project acquired this distribution from AP-42 Section 13.2.4 and applied it to fugitive dust emissions from haul roads. Because Section 13.2.4 applies to aggregate handling and storage piles, other sources were consulted to validate the use of this particle size distribution for haul road dust. A study by Watson, Chow and Pace referenced in a New Jersey Department of Environmental Protection report found that 52.3% of the particulate from road and soil dust is less than 10 µm in diameter. Of this particulate 10.7% was found to be smaller than 2.5 µm in diameter and the remaining 41.6% fell between 10 and 2.5 µm. Assuming that fugitive dust</p>	Disagree no revision made in CEA	yes	No CEA revision made.

				<p>particle sizes follow a lognormal distribution, these two data points were transformed into a multi-point particle size distribution for comparison to the original particle size distribution. The geometric mass mean diameter for the original distribution is 6.47 <math>\mu\text{m}</math>, while the mean diameter for the lognormal distribution is 5.76 <math>\mu\text{m}</math>. EPA's AP-42 Section 13.2.2 and supporting studies characterize PM<sub>30</sub> from unpaved road dust (the dominant source at Dewey-Burdock) as 30.6% PM<sub>10</sub> and 3.06% PM<sub>2.5</sub>. Again, assuming a lognormal particle size distribution, the mean diameter would be 6.77 <math>\mu\text{m}</math>. CDPHE has approved a mean coarse particle diameter for road dust of 6.25 <math>\mu\text{m}</math> (Trinity 2016; Exhibit 035). Since these values are clustered around the original PM<sub>10</sub> size distribution, it was retained for both CALPUFF and AERMOD dry deposition modeling.</p> <p>As stated above, the mass mean diameter of PM<sub>10</sub> particles with the chosen size distribution referenced above is 6.47 <math>\mu\text{m}</math>, or approximately 65% of the top diameter. Applying this ratio would yield about 1.5 <math>\mu\text{m}</math> for the mean PM<sub>2.5</sub> particle size. Hence, the choice of 1 <math>\mu\text{m}</math> mean particle size diameter for PM<sub>2.5</sub> was conservative in that it increases atmospheric entrainment and decreases settling. In contrast to PM<sub>10</sub> modeling, the plume depletion option had only a minor effect on modeled PM<sub>2.5</sub> impacts.</p> <p>Aluminosilicate clay minerals that characterize soil dust in the project area typically have particle density near 2.65 g/cm<sup>3</sup>. As indicated in IML's final report (IML 2013; Exhibit 033), the Environmental Science Division of Argonne National Lab states, "A typical value of 2.65 g/cm<sup>3</sup> has been suggested to characterize the soil particle density of a general mineral soil. Aluminosilicate clay minerals have particle density variations in the same range." Another study of fugitive dust from unpaved road surfaces, by Watson and Chow, also cites 2.65 g/cm<sup>3</sup> for soil particle density (IML 2013; Exhibit 033). In a more recent analysis, the CDPHE-approved particle density for road dust is 2.655 g/cm<sup>3</sup> (Trinity 2016; Exhibit 035). Powertech requests that EPA update this discussion in light of the evidence presented in this comment.</p>			
C48	104	10.4.1	E	<p>In the 2<sup>nd</sup> paragraph, the statement is made that "dry depletion should have been applied to all receptors within the model domain." Using the dry depletion option, IML modeled all receptors with predicted 24-hour PM<sub>10</sub> impacts in the initial modeling run that, when added to background, were greater than the NAAQS of 150 <math>\mu\text{g}/\text{m}^3</math>. This threshold was chosen to demonstrate ultimate compliance of all initially high receptors. The regulatory default settings were used to screen potential problem receptors, and the dry depletion option was used to refine the model results only for those receptors. Since the dry depletion option has the effect of reducing (never increasing) predicted</p>	EPA disagrees no CEA revision made	yes	EPA disagrees, no CEA revision made.

				impacts, it was deemed unnecessary to apply this option to receptors already demonstrated to be below the NAAQS threshold. The predicted concentrations would only have decreased beyond those obtained under the regulatory default option. Powertech requests that EPA update this discussion in light of the evidence presented in this comment.			
C49	104	10.4.1	E	In the 3 <sup>rd</sup> paragraph, the statement is made that “the approach used by NRC will not account for the diesel engine exhaust PM <sub>10</sub> particles that will not settle out as quickly as the mechanically generated fugitive dust emissions.” Most of the non-fugitive sources of particulate emissions at Dewey-Burdock are diesel engines. EPA is correct that some error may be introduced by including combustion sources of PM <sub>10</sub> in the dry depletion runs. Most particulate matter in diesel exhaust falls within the PM <sub>2.5</sub> category and exhibits a much slower deposition rate than PM <sub>10</sub> . Nonetheless, fugitive sources are dominant at Dewey-Burdock, where diesel exhaust constitutes only 1% of the total PM <sub>10</sub> emissions. For this reason, and to avoid further complicating the final model run, IML grouped all PM <sub>10</sub> sources together. Powertech requests that EPA update this discussion in light of the evidence presented in this comment. <b>Revision:</b> added the following sentence, “The emission inventory showed small PM emissions from combustion relative to inventoried dust emissions. However, these emissions should not have been included in the simulations with dry deposition.”	EPA agrees and CEA edit made	yes	CEA edit made .Added sentence at left.
C50	110	10.4.2.1	E	With regard to the 24-hour PM <sub>10</sub> modeling results, the statement is made in the 1 <sup>st</sup> paragraph that “the top 3 values are of interest regardless of when they occurred.” For compliance demonstration, the standard design value is the 4 <sup>th</sup> high concentration over a 3-year period. This value is shown in Table 6-1 (IML 2013; Exhibit 033) and should not be confused with the yearly statistics also presented in that table. Powertech requests that EPA update this discussion in light of the evidence presented in this comment.	EPA disagrees. No CEA change made	yes	No CEA change made.
C51	111	10.4.2.2	T	In the second line, Powertech requests correcting the reference to “Table 11a”, which does not appear in this section.	Agree	no	Deleted “see Table 11a” in 10.4.2.2
C52	111	10.4.2.4	E	In the 1 <sup>st</sup> paragraph in this section, the statement is made that “IML and NRC determined there is evidence and precedent that supports excluding ground-level, fugitive PM <sub>10</sub> emissions from the assessment of project impacts on visibility at Wind Cave ... However, EPA did not support this approach for the SEIS.” As stated in the final report (IML 2013; Exhibit	Disagree. No changes made in CEA	yes	No changes made in CEA

			<p>033) and acknowledged by EPA, even without excluding coarse particulates, the 98<sup>th</sup> percentile of the annual 24-hour average changes in haze index is less than the contribution threshold of 0.5 dv. Still, IML conducted a final model run excluding coarse PM<sub>10</sub> for several reasons:</p> <ul style="list-style-type: none"><li>• CALPUFF predicted that 70% of visibility impairment at Wind Cave from the Dewey-Burdock Project was caused by coarse PM<sub>10</sub>. This goes against visibility modeling results obtained by various agencies including South Dakota DENR. Aerosols of sulfate and nitrate, organic carbon, and fine particulates (PM<sub>2.5</sub>) are generally the significant contributors to visibility impairment.</li><li>• To test the reasonableness of the modeled impact of coarse particulates on visibility at Wind Cave, IML used CALPUFF to model the impact of PM<sub>10</sub> coarse emissions from Dewey-Burdock at three test receptors (IML 2013; Exhibit 033). The receptors were placed 40, 80, and 116 km from the project, respectively. CALPUFF predicted higher relative contribution from coarse PM<sub>10</sub> as the distance from the project to the receptor increased. This outcome defies common sense and exposes the fallacy of modeling visibility without accounting for near-field deposition of coarse PM<sub>10</sub>.</li><li>• Notwithstanding EPA's challenge to the evidence and precedent appearing in the final report, the modeling protocol does cite NEPA precedent for excluding fugitive dust emissions from visibility impact modeling. This approach was followed in the Atlantic Rim EIS (IML 2013; Exhibit 033), which cited supporting documentation from the Western Regional Air Partnership (WRAP).</li><li>• A 2005 study (VISTAS 2005; Exhibit 036 at p. 3-13) states, "PM<sub>2.5</sub> particles, which have a mass median diameter around 0.5 μm, have an average net deposition velocity of about 1 cm/minute ... On the other hand, coarse particles ... have an average deposition velocity of about 1 m/minute, which is significant, even for emissions from elevated stacks." It seems unreasonable to model the long-range transport of both species as if they behaved the same.</li></ul> <p>Regarding exclusion of coarse particulates from stationary sources: It should be noted that stationary sources at Dewey-Burdock are combustion sources with negligible emissions compared to mobile sources and fugitive dust sources. Moreover, particulates from stationary combustion sources are 97% PM<sub>2.5</sub> (IML 2013; Exhibit 033) and were already accounted for since only coarse PM<sub>10</sub> was omitted from the final visibility model run. Powertech requests that EPA update this discussion in light of the evidence presented in this comment.</p>			
--	--	--	---	--	--	--

C53	113	10.5	T	In the 6 <sup>th</sup> line of this sentence, Powertech requests changing “in this SEIS” to “in the NRC SEIS”.	T: agree with revision	no	Edit made
C54	114	10.6	T	The last sentence in this section appears incomplete: “If Powertech does not implement one or more of these measures properly ...”  Now says: If Powertech does not implement one or more of these measures properly (especially measure 3 which is expected to result in a 60% or better reduction in emissions generated from onsite unpaved roads), then the administrator may no longer find that cumulative effects are acceptable.	Addressed in 2019 version; already updated in final CEA	yes	Addressed in 2019 version already
C55	114	10.6.1	E	In the 2 <sup>nd</sup> paragraph in this section, the statement is made that “the Dewey-Burdock project has not been shown to greatly effect [ <i>sic</i> ] regional cumulative air quality.” This should be expected, given the comparison between project emission levels and regional emissions. Since fugitive PM <sub>10</sub> emissions from Dewey-Burdock constitute the largest single pollutant, and since EPA’s analysis takes issue with the degree of conservatism in modeling fugitive PM10 impacts on air quality and visibility, the following table may lend some perspective:  Source: EPA 2017; Exhibit 037  Since Wyoming is situated generally upwind from Wind Cave National Park, fugitive dust from this state may be more relevant than dust from South Dakota. Projected maximum fugitive PM10 emissions from Dewey-Burdock represent 0.08% of the emissions from Wyoming’s three largest sectors, and 0.11% of the emissions from South Dakota’s two largest sectors. Powertech requests that EPA update this discussion in light of the evidence presented in this comment.	no change in CEA needed	yes	No change in CEA



C56	114	10.6.2	T	In the number list, it appears that “Implement fuel saving practices such as minimizing vehicle and equipment idle time” should be item #1.	T: agree with revision	no	Edit made
C58	119	11.3.1	E	In the first paragraph, the statement is made that “the year one facility construction does not appear to be distinguishable in the estimation of CO <sub>2</sub> emissions related to electrical power consumption during the construction phase.” Powertech notes that the GHG emissions from year 1 construction amount to about 0.2% of the cumulative, project GHG emissions. For clarity, however, most of the electricity consumed during the Dewey- Burdock construction phase will be for facilities construction, where utility power will be available. Wellfield construction will involve primarily mobile and earth-moving equipment to drill wells and install piping and power lines. Electricity use in the wellfields will correspond mainly to the operations phase. Powertech requests that EPA update this discussion in light of the evidence presented in this comment.	Agree in part	yes	Edits made in CEA
C59	119	11.3.2	T	In the first paragraph in this section, 5 <sup>th</sup> line, Powertech requests correcting “whither” to “either”.			No “whither” could be found. No edit made
C60	121	Tables 33-34	T	It appears that metric tons and short tons are switched in several rows (i.e., those where the metric tons are higher than the short tons). Powertech recommends correcting these tables.	Agree that table needs updates	yes	Edits to metric tons column made in CEA. See table below.
C61	122	11.4	E	In the 4 <sup>th</sup> paragraph, the statement is made that the NRC SEIS does not include any information about GHG emissions during the uranium enrichment phase. Enrichment is downstream from the Dewey-Burdock Project. IML considered the analysis of this phase beyond the scope of the SEIS just as it did the analysis of an ultimate use for the enriched uranium (i.e., nuclear power plants). EPA acknowledges, and many studies support the net reduction in life-cycle GHG emissions achieved by nuclear power when it displaces fossil fuel power. Notably, the GHG reporting rule does not include uranium enrichment facilities or nuclear power plants among the 41 industrial sectors required to report. Powertech requests that EPA update this discussion in light of the evidence presented in this comment.	Disagree that update of CEA needed	yes	

C62	130	12.1	T	In lines 4-6, it appears that references to "Table 29" should be changed to "Table 36".	T: agree with revision; table 29 refers to emissions from the entire construction period.	no	
C63	133	12.2	C	In the 1 <sup>st</sup> paragraph, the statement is made that Powertech proposes to store, use, and receive shipments of anhydrous ammonia (NH <sub>3</sub> ). Powertech does not propose to use ammonia at the Dewey-Burdock Project. Figure 3.2-6 in the approved NRC license application shows that sodium hydroxide will be used in the precipitation circuit instead. Table 3.2-1 in the approved NRC license application, which lists the process-related chemicals and quantities planned for the project, likewise does not include ammonia. Powertech requests removing mention of anhydrous ammonia from this paragraph.	T: agree with revision	yes	Edits made in CEA
C64	133	12.3	T	In the 2 <sup>nd</sup> paragraph in this section, 1 <sup>st</sup> line, Powertech requests correcting "Table 30" to "Table 38".	T: agree with revision; Table 38 refers to <b>Table 30. Annual Estimated CO2 Emissions from Electrical Power Consumption</b>	no	Edit made
C65	134	12.5	C	The statement is made that "Because the Dewey Road is a county road, presumably it is maintained by Custer and Fall River Counties." These counties do maintain their respective portions of the Dewey Road. Moreover, Powertech executed an agreement with Fall River County to provide equipment, materials, and/or financial assistance to cover a portion of the total road maintenance cost for Fall River County roads used by Powertech during construction and operation (Powertech 2007; Exhibit 038). Powertech requests revision of the text to reflect this commitment.	Agree with revision Exhibit 038 attached to 5/13/20	yes	Edit to CEA made- to strike out "presumably"

					email		
C66	135	13.1	C	In the 1 <sup>st</sup> sentence in this section, the statement is made that NRC evaluated the impacts of transporting “yellowcake slurry.” Slurry is an intermediate product in the yellowcake production cycle that is dried to produce the final yellowcake product. This is described in Section 3.2.3.1 of the SER: “The CPP will also contain 2 vacuum dryers for drying yellowcake slurry into its final powder form” (Exhibit 014 at p. 96). Powertech requests removing the word “slurry” since yellowcake slurry will not be shipped from the Dewey-Burdock Project site.	Agree with revision.	yes	Edit made in CEA by saying “dried yellowcake” instead.
C67	135	13.1	I	In the 2 <sup>nd</sup> line, Powertech requests changing “radioactive wastes” to “byproduct material” for consistency with other sections of this document (e.g., Section 12.2).	I: Agree with revision	no	Edit made
C68	140	14.3	E	A discussion is included about traditional subsistence practices such as hunting and wild plant gathering. Powertech suggests mentioning that the entire Dewey-Burdock permit area is either private land or BLM- managed federal land for which no public access roads exist. Therefore, there is no plausible use of lands within the proposed permit area for “traditional subsistence practices and the procurement of animals and plants for		yes	This section of the CEA was deleted so comment is obsolete. See RTC
				ritual, ceremonial, medicinal and other traditional needs.” Powertech requests the addition of text to indicate that there is no public access to lands within the proposed permit area.		no	
C69	144	15.3.1	C, I	In the 1 <sup>st</sup> paragraph, the statement is made that the maximum liquid byproduct material quantity requiring disposal in the deep well injection option will be 197 gpm. As described in comment #C35 and as correctly listed in the 3 <sup>rd</sup> paragraph in this section, the correct maximum volume of liquid waste injection during concurrent operations and aquifer restoration is 232 gpm. Powertech requests correcting the maximum liquid waste generation rate in the deep disposal well option from “197 gpm” to “232 gpm”.	I: Agree with revision	yes	Edit made

C70	144	15.3.1	C	<p>In the 2<sup>nd</sup> paragraph, the statement is made that “Powertech proposed the construction of two Minnelusa injection wells, DW No. 1 in the Burdock Area and DW No. 3 in the Dewey Area.” This does not appear to be consistent with the Class V permit application or Draft Class V Area Permit, both of which discuss up to four Minnelusa injection wells. Powertech requests updating the discussion to account for the four Class V injection wells included in the Class V Area Permit.</p> <p><b>Revision to CEA:</b> Powertech has proposed the construction of one Minnelusa well in the Burdock Area; however, the Class V Area Permit allows the construction of up to four Minnelusa wells if required for disposal of the volume of waste fluids produced at the site.</p>	Agrees clarification is needed.	yes	See revision at left for CEA update
C71	144	15.3.2	C	<p>In the 1<sup>st</sup> paragraph in this section, the statement is made that the maximum production of liquid byproduct material in the land application option will be 547 gpm. As described in comment #C36, the correct maximum volume of liquid waste injection during concurrent operations and aquifer restoration is 582 gpm. Powertech requests correcting the maximum liquid waste generation rate in the land application option from “547 gpm” to “582 gpm”.</p>	I: Agree with revision	yes	Edit made in CEA and RTC
C72	145	15.3.4	C	<p>Powertech requests clarifying that the 66 cubic yards of solid byproduct material is an annual estimate during operations. This comment also applies to Section 15.4.4.</p>	T: Agree. Add “annually” after 66 cubic yards on both places.	yes	Edits made in CEA
C73	146	15.4.1	C	<p>The statement is made that “Powertech proposes to manage aquifer restoration wastewater (i.e., liquid byproduct material) by treating the <u>wastewater</u> by reverse osmosis and reinjecting the treated water (i.e., permeate) back into the aquifer production zone undergoing restoration as described in SEIS Section 2.1.1.1.4.1” (emphasis added). Powertech requests clarification that the water withdrawn from the wellfields during groundwater restoration is not wastewater; it is treated by reverse osmosis (in the deep disposal well option), and the resulting reject is treated and disposed as wastewater. The water withdrawn from the wellfield and the treated water (permeate), while still considered 11e.(2) byproduct materials under NRC regulation, are not wastewater. Powertech requests modifying this sentence as follows:</p> <p>Powertech proposes to manage <b>water pumped from the ISR wellfields during</b> aquifer restoration <b>wastewater</b> (i.e., liquid byproduct material) by treating the</p>	Agree with revisions	yes	Edits made

				wastewater by reverse osmosis and reinjecting the treated water (i.e., permeate) back into the aquifer production zone undergoing restoration as described in SEIS Section 2.1.1.1.4.1.			
C74	146	15.4.2	E	In the 11 <sup>th</sup> line in this section, the statement is made that “The NRC, the DENR and the EPA will require liquid byproduct material be treated prior to injection and treatment systems be approved, constructed, operated, and	agree	yes	Updated CEA
				monitored to ensure release standards ... are met.” Powertech is not aware that EPA has any permit requirements for the land application of treated wastewater and requests clarification on this statement or removal of EPA from the list of agencies authorizing land application.  <b>Revision to CEA:</b> Change sentence to state: The NRC and the DENR will require liquid byproduct material be treated prior to land application and treatment systems be approved, constructed, operated, and monitored to ensure release standards in 10 CFR Part 20, Subparts D and K and Appendix B are met.	Same as above	Same as above.	Same as above
C75	147	15.5.1	C	Regarding the statement that Powertech expects to install 4,000 injection and production wells, please refer to comment #E1 in Table 3, which describes how Powertech currently estimates that approximately 1,461 injection wells and 869 production wells will be required over the life of the project.  <b>Revision to CEA:</b> “Powertech expects to install approximately 4,000 injection and production wells” to say: “Powertech expects to install approximately 1,461 injection wells and 869 production wells over the life of the project.”	Agree. Table 3 (comments on the AE ROD) begins on page 52 of Powertech’s Class III comment document	yes	Edits made at left
C76	148	15.5.2	E	Powertech requests explanation of the reference for the statement that “The NRC will update this evaluation as part of the pre-operational analysis for the Dewey-Burdock Project Site, and certify that binding contractual arrangements and commitments for providing capacity for the proposed Dewey-Burdock ISR Project have been made with one or both of these landfill options prior to beginning construction.”	agree	yes	Statement deleted from CEA

C77	149	15.5.4	T	In the 2 <sup>nd</sup> paragraph, last line, Powertech requests correcting “Section 14.3.1” to “Section 15.3.1”.		no	edit made
C78	149	15.6	C	The statement is made that “Powertech will be required to have an agreement in place with White Mesa Mill for the disposal of solid by-product waste.” Although White Mesa Mill has been identified as the preferred location for disposal of solid byproduct material, the NRC license does not require an agreement with any particular 11e.(2) byproduct material disposal facility. The requirements in NRC License Conditions 12.6 and 9.9, as stated on page 150 of this document, require Powertech to submit to the NRC a disposal agreement with a licensed disposal site before beginning operations and to maintain an agreement throughout operations. Powertech requests revising this sentence as follows: <p style="margin-left: 40px;">Before the NRC will authorize commencement of ISR operations, Powertech will be required to have an agreement in place with <b>a facility that is licensed by the NRC or an NRC Agreement State to receive byproduct material, such as the White Mesa Mill</b> <del>for the disposal of solid by-product waste.</del></p>	Agree with revision	yes	Edit made
C79	150	15.6	T	In the last paragraph in this section, 3 <sup>rd</sup> line, Powertech requests deleting “76” in “76 License Condition 9.9 ...”	T: agree with revision	no	Edit made
C80	150	16.0	T	In the 1 <sup>st</sup> paragraph in this section, 7 <sup>th</sup> line, Powertech requests correcting “Table 32” to “Table 39”.	T: agree with revision	no	Edit made
C81 – New Comment	19	3.3.1	C	The statement "The EPA is proposing approval of the aquifer exemption for Burdock wellfields 6 and 7 after well 16, which is a former drinking water well completed in the proposed aquifer exemption area, is plugged and abandoned" is not correct. There are now three approaches in the Revised Draft Class III Permit and Aquifer exemption record of decision to address this. As noted in E-14, Powertech believes that as written option three provides a reasonable and suitable approach to address well 16. Powertech requests that this statement be updated accordingly.	Agree with revision	yes	Edit made

C82 – New Comment	19	3.3.1	C	Reference is made to 40 CFR § 146.10(4). There needs to be an (a) in front of the (4)	T: agree with revision	no	Edit made
C83 – New Comment	20	3.3.2.1	C	"The monitoring well detection system described in Section 12.5.5.2 of the Class III Area Permit Fact Sheet" is an incorrect reference. Powertech believes this reference should be Section 12.4	I: Agree	no	Edit made
C84 – New Comment	57	5.2.3	I	Contains the statements "The header house components will be connected to programmable logic controllers that send data to the control systems components will be connected to programmable logic controllers that send data to the control systems." and "In addition, the flow rate of each production and injection well will be measured automatically. Measurements will be collected and transmitted to both the Central Processing Plant and Satellite Facility control systems." are inconsistent with the permit application and the Revised Draft Class III Permit which says flows will be recorded daily (Part VIII. F.4.b.iii.)	agree	yes	Edit made
C85 – New Comment	60	5.2.5	T	1st bullet contains reference to Section 5.9. Powertech believes this should be Section 5.8	I: agree. But think commenter meant section 5.2.4	no	Edit made
C86 – New Comment	71	6.0	T	"Propose" should be "proposed".	T: agree with revision	no	Edit already made in 6.0
C87 – New Comment	73	7.1	T	"Area" should be "areas"	T: yes, in the sentence: "high-volume heavy-vehicle traffic within certain area"	no	Edit made

C88 – New Comment	74	7.2	T	"Area" should be "areas"	Maybe a typo? Didn't see a similar need for fix in 7.2	no	
C89 – New Comment	76	7.4.1	C	States that "Powertech estimates the maximum volume of liquid wastes injected into the deep injection wells during aquifer restoration will be 155 gpm". Powertech believes the word volume should be replaced with "flowrate"	Agree with revision	yes	Edit made
C90 – New Comment	77	7.5	T	The sentences "Plugging and abandoning injection and production wells according to the EPA UIC Area Permit requirements. Plugging and abandonment of monitoring wells must be in accordance with South Dakota requirements." Powertech believes that a bullet before the second sentence should be included as both are requirements.	T: agree	no	Edit made
C91 – New Comment	81	8.2.1	T	Contains reference to Section 5.9. Powertech believes this should be Section 5.8	agree	yes	Edit made
C92 – New Comment	139-140	14.2	C	See comments 103-107 on new wildlife requirements above. Powertech repeats these comments here and requests any changes made to these requirements be addressed here as well.			
				Comments 103-107: wildlife requirements/permit conditions	See RTC ESA responses		
103 - New Comment	85	<b>Part XIV, Section B.</b>		Powertech requests clarification on the basis of a 1-mile avoidance buffer for the whooping crane, rufa red-knot and northern long-eared bat and how this was determined to be protective. Such a buffer appears to be much greater than typical wildlife buffers and was formulated without basis within the documents provided. From the documents provided, it appears that the buffer was arbitrarily increased from 1/4 mi to 1 mile by EPA and applied to other species arbitrarily.			



greeNo.	Page	Recommended Alternative Language or Other Modification	Explanation of Alternative(s)	Comment
			Powertech recommends that a mitigation plan be allowed to be developed upon observation of these species. Such a plan could involve various strategies to avoid a take.	
104 - New Comment	85	<b>Part XIV, Section B.</b>	Powertech requests modification of the requirement that all operations and construction must cease within 1 mile upon sighting a whooping crane, rufa red-knot or northern long-eared bat. In particular, active operations cannot be immediately ceased as this could endanger protection of USDWs as operations are required to be manned. As well, this could create serious issues with compliance conditions within the Class III permit, for example, the need to continuously maintain a bleed on the wellfield. Powertech recommends that a mitigation plan be allowed to be developed upon observation of these species. Powertech questions the authority of the EPA to enforce such requirements. Such conditions are enforceable under the South Dakota DENR Large Scale Mine Permit, and Powertech believes these requirements are better applied in this fashion, with direct interaction with SD GFP, where trained wildlife biologists can determine an appropriate approach.	
105 - New Comment	85	<b>Part XIV, Section B.</b> "Mitigation measure 5: If supplemental lighting is used during construction or operation, the lights must be directed and/or sheltered to minimize the amount of light escaping the work or project site."	This condition appears arbitrary and not tied to the known presence of wildlife of concern. Powertech suggests that this condition be modified so that if a whooping crane, rufa red-knot or northern long-eared bat have been confirmed at the site by trained wildlife biologist, then such a condition would be applied if deemed appropriate by a trained wildlife biologist.	
106 - New Comment	85	<b>Part XIV, Section B. The Endangered Species Act (ESA), 16 U.S.C 1531 et seq.</b> Section 7 of the ESA and its implementing regulations (50 CFR part 402) require the EPA to ensure, in consultation with the Secretary of the Interior or Commerce, that any action authorized by EPA is not likely to jeopardize the continued existence of any endangered or threatened species or adversely affect its critical habitat.	From the biological assessment documents provided, it does not appear that the EPA sought specific input on the parameters of mitigation for the whooping crane and rufa red-knot prior to creating permit requirements. Powertech requests clarification on the Section 7 consultation with the Secretary of the Interior (U.S. Fish and Wildlife Service). Are the mitigation measures described in the draft permit a result of	

No.	Page	Recommended Alternative Language or Other Modification	Explanation of Alternative(s)	Comment
				this consultation? If not, Powertech requests that this section be revised once consultation has been completed.
107 - New Comment	85	<p><b>Part XIV, Section B. The Endangered Species Act (ESA), 16 U.S.C. 1531 et seq.</b></p> <p>8. During the northern long-eared bat active season (April 1 to October 31), the Permittee shall use a motion-activated camera to monitor the Triangle Mine vertical ventilation shaft located at NWNW Section 35, T6S, R1E for 5 days and nights and determine if bats are entering and exiting. If no bats are observed entering or exiting the shaft, the Permittee shall investigate the shaft to determine if bats are inside the shaft. If no bats are inside the shaft, the Permittee shall cover the entrance to the shaft with finer mesh to prevent bats from entering. If bats are observed in the shaft, the Permittee shall work with South Dakota Game, Fish and Parks to evaluate methods for establishing an appropriate buffer zone around the shaft to prevent tree removal or wellfield construction activity. The buffer zone will need to take into account the fact that the shaft is only a few feet away from a road that is used by local residents and may be improved to use as an access road to the Project Site.</p>	Powertech requests clarification on the frequency of the motion-activated camera monitoring. Powertech requests clarification that additional monitoring will not be required if the shaft entrance is covered following a determination that no bats are inside the shaft.	